

version 3.1.4

Table of Contents

Part I Getting Started with Light-O-Rama	8
Part II What's New?	13
Part III Feature Comparison	75
Part IV Light-O-Rama Concepts	83
1 Sequences.....	84
Animation Sequences	87
Musical Sequences	88
Channels	89
RGB Channels	92
Channel Groups	95
Timings	102
Effects	105
Loops	114
Tracks	116
Animations	119
Subsequences	120
Windows Shell Commands	121
Compressed Sequences	124
Protected Sequences	125
2 Shows.....	125
Interactive Groups	134
3 Schedules.....	139
The Weekly Schedule	140
The Calendar Schedule	141
4 Hardware	143
Light-O-Rama Controllers	144
Native DMX Devices	148
Dasher Controllers	148
Digital IO Cards	151
BSOFT Digital IO Cards	153
X10 Controllers	154
Part V The Light-O-Rama Software Package	156
1 Registering Light-O-Rama.....	157
Registering Offline	158
2 Control Panel.....	160
3 Sequence Editor.....	169
Editing Sequences Using the Keyboard	170
Editing Sequences Using the Mouse	176
Time Format	178
The Menu Bar	178

The File Menu.....	179
The New and Open Dialog.....	181
The New Animation Dialog.....	184
The New Musical Sequence Dialog.....	187
The Edit Menu.....	190
The New Track Dialog.....	202
Preference Dialogs.....	204
Clipboard Preferences.....	205
Display Preferences.....	206
Advanced OpenGL Settings.....	212
DMX Preferences.....	213
Holiday Lights Designer Preferences.....	213
Keyboard Preferences.....	214
Visualizer Preferences.....	221
Network Preferences.....	222
New Animation Preferences.....	226
New Musical Sequence Preferences.....	226
Play Preferences.....	227
Video Preferences.....	230
Zoom Preferences.....	231
The View Menu.....	231
The Tools Menu.....	240
The Play Menu.....	260
The Window Menu.....	265
The Help Menu.....	267
Toolbars	268
The Standard Toolbar.....	268
The Tools Toolbar.....	273
The Track and Timings Toolbar.....	277
The Tools Panel	279
Saved Tools.....	282
Recent Tools.....	282
Clipboards.....	283
The Right-Click Context Menu	289
Channel and RGB Channel Buttons	295
Channel Settings.....	297
RGB Channel Settings.....	298
Channel and RGB Channel Buttons' Popup Menus.....	298
Insert Device	303
Convert to RGB Channel.....	310
Convert to Channel Group.....	311
Track Bars	312
Track Bars' Popup Menus.....	313
Loop Menus	315
The Loop Context Menu.....	316
Loop Level Buttons.....	319
The Waveform	319
The Animator	322
The Beat Wizard	325
The Channel Configuration Screen	328
The MIDI Wizard	332
The Effects Summary Tab.....	333
The Various Effects Tab.....	334
The Individual Notes Tab.....	337

The Tapper Wizard	339
The VU Wizard	342
Freeform Play Mode	345
4 SuperStar Sequencer.....	346
Welcome	346
Overview	347
Instant Sequences	349
Custom Sequences	351
Creating a Scene.....	352
Export	355
Creating a Morph.....	357
Creating an Image Action.....	361
Creating an Animation.....	363
Creating Text.....	367
Transfer Effects from One Sequence to Another.....	374
Load/Save Clipboard.....	374
Change to 10 Pixels per Ribbon.....	375
"Star Rays", "Wide Grid", and "Thin Grid".....	377
The Layout Dialog Box.....	378
Balanced Color Mode / Full Color Mode.....	379
Smooth Ramps.....	380
Configure Controller Unit IDs Using the Light-O-Rama Hardware Utility	382
Configure Controller Unit IDs in the SuperStar Sequencer.....	382
Channelizer.....	384
Select All, Select All Left, and Select All Right.....	387
Importing a Timing Grid and up to 3 Timing Channels.....	387
Visualization Sequences	387
Summary of Commands and Keyboard Accelerators	391
Toolbar Summary.....	391
Toolbar Buttons that have Keyboard Modifiers	391
Timeline and Effect Object Selection.....	392
Top Part of Color Controls.....	393
Color Picker Dialog Box.....	393
Bottom Part of Color Controls.....	393
Sequencing Grid Commands for Scenes.....	394
Selection Grid Commands for Morphs.....	395
5 Show Editor.....	395
6 Schedule Editor.....	397
7 Simple Show Builder.....	403
8 Show Player.....	409
9 Comm Listener.....	410
10 Hardware Utility.....	410
Light-O-Rama Controllers	411
Selecting a Comm Port.....	412
Setting Unit IDs.....	413
Configuring Units.....	415
Testing Units.....	421
Downloading Sequences.....	425
Firmware Updates.....	429
Light-O-Rama MP3 Directors	431
Light-O-Rama Wireless Devices	435
Digital IO Boards	437

X10 Controllers	438
Test Console	439
11 ServoDog Utility.....	441
12 Visualizer.....	442
System Requirements	443
Limits	443
Concepts and Terminology	444
Tutorial	446
Advanced Topics	451
Wizards	452
Tree Wizard	452
Arch/Fan Wizard.....	453
CCR Wizard	453
CCR Matrix Wizard.....	453
Channel Assignment Wizard.....	454
Reference Channels.....	455
Virtual Channels.....	456
Importing and Exporting Fixtures and Props	456
Symbols	457
Locks	457
Levels	458
Colors and Background Intensity.....	458
Using Cosmic Color Devices in the Visualizer.....	458
Multi-Color Channels (Strings).....	459
Simulation and Firew alls	460
Dialog Windows	461
About	462
Arch/Fan Wizard.....	462
Assign Fixtures from Wizard.....	464
Assign to Fixture.....	465
CCR Matrix Wizard.....	466
Change Size.....	467
Channel Assignment Wizard.....	468
Channel Assignment Wizard: Non-CCR Fixtures.....	468
Channel Assignment Wizard: CCR Fixtures.....	474
Channel Settings Dialog.....	476
Draw CCR Wizard.....	477
Duplicate Channel Reference	478
Duplicate RGB Channel Reference.....	479
Fixture Properties.....	481
Insert Symbol Fixture.....	483
Level Visibility and Properties.....	485
Load LOR Reference File.....	487
Main Editing Window	487
Main Editor Window	487
Menu Items.....	488
New Prop.....	488
New Simulation.....	489
Object Selection Area.....	490
Options	490
Options Tab 1: General.....	490
Options Tab 2: Tooltips	492
Options Tab 3: Colors	494

Options Tab 4: Fixtures.....	494
Options Tab 5: Bulbs.....	495
Options Tab 6: Com/Ref.....	496
Prop Properties.....	497
Prop Properties: General Tab.....	497
Prop Properties: Change Fixture Properties Tab.....	498
Prop Properties: Wizards Tab.....	499
Rename Fixture.....	500
Rename Prop.....	500
Reorder Prop (Change Fixture Order).....	501
Select Reference Channel.....	501
Simulation (Background) Properties.....	502
Simulation (Compile) Errors.....	504
Status Bar.....	504
Toolbars.....	504
Edit Toolbar.....	504
Actions Toolbar.....	505
Color Toolbar.....	506
Tree Wizard.....	506
Mouse Wheel.....	509
Shortcut Keys.....	509
13 Verifier.....	509
List of Verifier Messages.....	511
Verifier Messages 1-10.....	512
1: No errors or warnings found.....	512
2: Verification cancelled.....	512
3: Light-O-Rama is not installed.....	513
4: No registry entry for application path.....	513
5: Application directory does not exist.....	514
6: Verifier not running from LOR application path.....	514
7: Application file does not exist.....	514
8: Unlicensed LOR demo version used.....	515
9: Unsupported version of Windows Media Player.....	515
10: No registry entry for user data path.....	515
Verifier Messages 11-20.....	516
11: User data directory does not exist.....	516
12: No registry entry for non-media data path.....	517
13: Non-media data directory does not exist.....	517
14: No registry entry for media data path.....	518
15: Media data directory does not exist.....	518
16: Application file has unexpected version number.....	519
17: Weekly schedule file does not exist.....	519
18: Yearly schedule file does not exist.....	520
19: Calendar scheduling not supported.....	520
20: No shows are scheduled.....	521
Verifier Messages 21-30.....	521
21: Show file does not exist.....	521
22: Error reading show file.....	522
23: Sequence file does not exist.....	522
24: Sequence file cannot be loaded.....	523
25: Show has no sequences.....	523
26: Media file does not exist.....	523
27: Conflicting channel settings in sequence.....	524
28: Channel is completely off.....	525

29: Sequence is completely off.....	525
30: Channel is missing settings.....	525
Verifier Messages 31-40.....	526
31: Channel uses undefined comm network.....	526
32: Channel in tracks of conflicting length.....	526
33: Musical file used in non-audio section of show	527
34: Subsequences not supported.....	527
35: Background sequences unsupported.....	528
36: Startup sequences unsupported.....	528
37: Shutdown sequences unsupported.....	529
38: Interactive triggers unsupported.....	529
39: Unsupported number of tracks.....	530
40: Shell commands unsupported.....	530
Verifier Messages 41-50.....	531
41: Shell command map file does not exist.....	531
42: Shell command not set.....	531
43: Channel conflict.....	532
14 Diagnostic.....	532
15 Offline Registration Utility.....	533
16 Add-Ons.....	534
Registry Wiper	535
Holiday Lights Designer	535
Universal Library and InstaCal	536
 Index	 537

1 Getting Started with Light-O-Rama

Welcome to Light-O-Rama

Light-O-Rama is a computerized lighting system designed to control elaborate or simple lighting displays. The Light-O-Rama system can be applied to almost any lighting situation, from stand-alone controllers to synchronizing hundreds of controllers.

This page gives a high-level overview of how to start controlling your lights using Light-O-Rama:

- [Getting Help about Light-O-Rama](#)
- [Important Terms and Information](#)
- [Connecting the Lights Using Light-O-Rama Controllers](#)
- [Creating a Show](#)

For more detailed information, please see [Light-O-Rama Concepts](#) and [the Light-O-Rama Software Package](#).

Experienced users may wish to see [what's new](#) in the latest version of Light-O-Rama.

Getting Help about Light-O-Rama

Other than this help file, there are several ways to get help about Light-O-Rama:

Frequently Asked Questions, quick start guides, training presentations, tutorials, demos, and user guides can be found on the [Support](#) page of the [Light-O-Rama website](#), along with phone, mail, and email contact information.

Light-O-Rama users' forums can be found at the [LOR Users Support Center](#).

The [LOR Wiki](#) is a user-created and edited repository of Light-O-Rama information. ***Please note that the information contained in the LOR Wiki is not published by Light-O-Rama, and cannot be considered official.***

Important Terms and Information

Companion Unit

A **companion unit** is a Light-O-Rama controller that receives lighting commands from another source - either a PC running Light-O-Rama software, or from another controller known as a [director unit](#).

Control Panel

The [Light-O-Rama Control Panel](#) is a program that can be used to manage the Light-O-Rama system on your PC. The Control Panel runs in the system tray (where the PC's clock is displayed). Light-O-Rama is made up of [a number of different programs](#), and the Control Panel is a convenient way of accessing them. The Control Panel must be running in order to control [shows](#) from your PC.

Daisy Chain

This is the term generally used to describe the manner in which Light-O-Rama light controllers are connected. A [wire](#) goes from the source (a PC running Light-O-Rama software or a [director unit](#)) to a [companion unit](#). Another wire goes from that companion unit to another companion unit, and so on, until all companion units are "chained" together.

Do not put "Y"s or forks in the data cable. Only connect the units in this daisy chain configuration.

Data Cable

Light-O-Rama controllers can be [connected](#) using both data cables and [phone cables](#), but you *must* know which type of cable it is (for the purposes of Light-O-Rama, a cable is considered a **data cable** if its wires are connected straight through).

How do you know if it is a data cable? Well, most likely the only cable that you will see that is *not* a data cable is a wire that is intended specifically for phones. If you go to your local hardware store and purchase a phone extension cable, then that wire is *not* a data cable. The distinction between data cables and phone cables is important, because the wires are swapped around. There are selectors or jumpers on most Light-O-Rama controllers that allow you to specify which wire type you are using.

Only the wire coming into a controller (from the previous controller or from a PC running Light-O-Rama software) should be used to determine which selector setting to use. The wire leaving a controller (if there is one) can be of any type, and has no bearing on which selector setting should be used. For example, if a controller has a phone cable coming in from the previous controller, and a data cable leaving to the next controller, the selector should be set for "phone cable".

Director Unit

A **director unit** is a Light-O-Rama controller that sends lighting commands to other controllers (known as [companion units](#)). Controllers can run individually in [standalone mode](#), but to synchronize multiple controllers together, they must be directed either by a PC running Light-O-Rama software, or by a director unit.

Standalone [sequences](#) may contain lighting commands for a number of different units. A director unit is a unit that is running standalone - i.e. not connected to a PC - that contains lighting commands for other units cabled to it (the companion units). The director unit can also control its own lights, simultaneously.

There is no difference in the hardware of a director unit and a companion unit - the only difference is the mode that they are in.

A PC running Light-O-Rama software can also be thought of as a director unit, in that it can send lighting commands to Light-O-Rama controllers. There must be one *and only one* director unit (or PC running Light-O-Rama software) on a [daisy chained](#) group of controllers.

Hardware Utility

The [Light-O-Rama Hardware Utility](#) is a program that can be used to set up and test the hardware used to control lights, as well as download [sequences](#) to [standalone controllers](#) or [director units](#).

Phone Cable

Light-O-Rama controllers can be [connected](#) using either data cables or **phone cables**, but you must know which type of cable you are using. See [data cables](#) for details.

Schedule

A [schedule](#) is a list of [shows](#) and the times at which those shows are to be played.

If the Light-O-Rama [Control Panel](#) is running on a PC, and its "[Enable Schedule](#)" option is turned on, then the schedule will be monitored, and its shows will be started and stopped at the appropriate times.

The [Schedule Editor](#) program is used to create and modify schedules.

Sequence

A [sequence](#) is a file that contains a set of lighting commands to be sent to Light-O-Rama controllers. There are two types of sequences: [musical sequences](#), which have an associated music or video file that is to be played at the same time, and [animation sequences](#), which do not.

Sequences can be grouped together into [shows](#).

The [Sequence Editor](#) program is used to create and modify sequences.

Show

A [show](#) is a file that contains a number of [sequences](#), and the order in which they should be played.

A [schedule](#) can be created to specify the times at which various shows should be played.

The [Show Editor](#) program is used to create and modify shows.

Standalone

A Light-O-Rama controller can be controlled by another controller (or a PC running Light-O-Rama software), or it can control itself and/or other controllers, in **standalone mode**. A [sequence](#), created using the [Sequence Editor](#), can be downloaded to a standalone controller using the [Hardware Utility](#). The controller can then be set up to run this sequence whenever it has power, or, if the unit is a model with an internal clock, it can be instructed to run the sequence during a particular time.

A standalone controller whose sequence contains lighting commands for other controllers will transmit those commands to the other controllers. In this case, the controller is known as a [director unit](#).

Unit

A **unit** is another term for a Light-O-Rama controller. Each unit has a number of circuits, each of which can be used to control lights independently of each other. Each unit is identified by a [unit ID](#).

Unit ID

Each [unit](#) has an identifier assigned to it, known as a **unit ID**. When a lighting command is sent to a unit, all of the units that are daisy chained together can see that command. However, the command contains a unit ID; only the units having that unit ID will act upon that command.

For [Light-O-Rama controllers](#), the unit ID is a two characters, each of which can have any of the values 0, 1, 2, 3, 4, 5, 6, 7, 8, 9, A, B, C, D, E, and F. For example, "01", "25", "37", "5C", "BD", or "E2". However, not all possible combinations are allowed: "00" and "F1" through "FF" are disallowed.

[Controllers other than Light-O-Rama controllers](#) use different formats for their unit IDs.

Connecting the Lights Using Light-O-Rama Controllers

To connect lights using Light-O-Rama controllers, take the following three steps:

1. [Determine the serial port and hook up a controller.](#)
2. [Select a unit ID.](#)
3. [Test the lights.](#)

Step 1. Determine the Serial Port and Hook Up a Controller

Insert an SC485 converter into your PC's DB9 serial connector which you plan on using for the Light-O-Rama network. If you are using a USB/RS-232 converter, then make sure that it is properly installed, and that the SC485 converter is connected. If you're not sure what all this is about, simply try to find a connector on the back of your PC that has nine pins and which will accept the SC485 adaptor.

Using a [cable](#), connect a Light-O-Rama controller to the SC485 adaptor. Make sure that the LOR controller is powered on. The LED in the controller should be blinking.

Using the Light-O-Rama [Control Panel](#), start the [Hardware Utility](#) program. In the Hardware Utility's **Setup Comm Port** section, use the **Auto Configure** button. This will cause the Hardware Utility to look for the attached controller and determine which comm port is being used.

Step 2. Select a Unit ID

If your controller has [unit ID](#) selection switches, you can select its ID by adjusting the selectors to the desired ID. If your controller does not have these unit ID selection switches, then you will need to set its unit ID by using the [Hardware Utility](#):

To set the unit ID using the Hardware Utility, connect **one and only one** unit to the PC using the SC485 adaptor and a [cable](#). In the **Set Unit IDs** section, go to **Set New Unit ID**, select the ID that you wish to use for the controller, and click the **Set Unit ID** button. This button will only work on new units that have never been assigned a unit ID (to change the unit ID of a unit that already has one assigned, use the **Change Existing ID** section instead).

TIP: Assign unit IDs sequentially, starting at 01. This will make maintenance of the units faster.

Step 3. Test the Lights

With the unit connected to the PC, attach lights and power the unit on. In the [Hardware Utility](#), click the **Refresh** button in the top center of the screen. After a short time, your unit should appear in the

dropdown list to the right of the **Refresh** button. Select the unit, and you can then test the lights using the various controls in the **Test Unit's Operation** section of the Hardware Utility.

TIP: Before clicking **Refresh**, set the Hardware Utility's **Max Unit ID** to as low a value as possible. This is the maximum unit ID of controllers that you plan on using (you can always change it to a higher value if you add more controllers later). Setting it to a low value makes the Hardware Utility run faster (though it will not find any connected units with higher unit IDs).

Creating a Scheduled Lights Display

To create a lights display and have it run at certain times, take the following steps:

1. [Make your sequences.](#)
2. [Make a show.](#)
3. [Make a schedule.](#)
4. [Turn on the Control Panel's "Enable Schedule".](#)

Step 1. Make Your Sequences

Using the [Sequence Editor](#), create the [sequences](#) that will be used in your show.

You can test how the lights will look for a sequence while in the Sequence Editor: Make sure **Control Lights** is turned on in the **Play Menu**, and that you have assigned the channels in the sequence to a controller that is hooked up to your PC. Then, click the play button (which is the green arrow in the toolbar).

Step 2. Make a Show

A [show](#) is a collection of [sequences](#). A show can be created using the [Show Editor](#) program.

Shows have several sections, each of which can have sequences:

- **Background:** Sequences listed in the "background" section will be played for the entire duration of the show.
- **Startup:** Sequences listed in the "startup" section will be played when the show first begins.
- **Animation and Musical:** After the "startup" sequences have completed, sequences in both of these sections will run, until it is time for the show to stop.
- **Shutdown:** When it is time for the show to stop, the "animation" and "musical" sequences will stop running, and the sequences in the "shutdown" section will start. Only after the "shutdown" sequences are finished will the show truly end.

In the Show Editor, you can add sequences to any of these sections by selecting the appropriate section's tab, and hitting the big PLUS button.

After you have created your show, you should save it using the "Save" or "Save As" button. Assign the show a meaningful name - this is the file name that you will be using in the next step.

Step 3. Make a Schedule

Unlike [sequences](#), you cannot run a [show](#) interactively. Instead, to test a show, put that show into a [schedule](#), using the [Schedule Editor](#) program:

In the Schedule Editor, click the **Add** button, and select the show file with the name that you created in the previous step. Select a start and end time that will allow the show to start at a convenient time for you to view it. Then click **Save** to save your schedule.

Step 4. Turn On the Control Panel's "Enable Schedule"

To view the scheduled show, turn on the "[Enable Schedule](#)" option in the Light-O-Rama [Control Panel](#). Doing this will cause the Control Panel to monitor your schedule, and start and stop your show at the appropriate times.

2 What's New?

What's New in Light-O-Rama

- [What's New in Version 3.1.4](#)
- [What's New in Version 3.1.2](#)
- [What's New in Version 3.1.0](#)
- [What's New in Version 3.0.2](#)
- [What's New in Version 3.0.0](#)
- [What's New in Version 2.9.4](#)
- [What's New in Version 2.8.12](#)
- [What's New in Version 2.8.10](#)
- [What's New in Version 2.8.8](#)
- [What's New in Version 2.8.6](#)
- [What's New in Version 2.7.6](#)
- [What's New in Version 2.7.4](#)
- [What's New in Version 2.6.2](#)
- [What's New in Version 2.6.0](#)
- [What's New in Version 2.5.6](#)
- [What's New in Version 2.5.4](#)
- [What's New in Version 2.5.2](#)
- [What's New in Version 2.4.10](#)
- [What's New in Version 2.4.8](#)
- [What's New in Version 2.3.8](#)
- [What's New in Version 2.3.6](#)
- [What's New in Version 2.3.4](#)
- [What's New in Version 2.1.6](#)
- [What's New in Version 2.1.4](#)
- [What's New in Version 2.1.2](#)
- [What's New in Version 2.0.16](#)
- [What's New in Version 2.0.14](#)
- [What's New in Version 2.0.12](#)
- [What's New in Version 2.0.8](#)
- [What's New in Version 2.0.4](#)
- [What's New in Version 2.0.0](#)
- [What's New in Version 1.5.0](#)
- [What's New in Version 1.4.0](#)

What's New in Version 3.1.4

- [Bug Fix](#)

Bug Fix

- In most cases, the [LOR Control Panel](#) would slowly leak memory resources, eventually leading to strange behavior such as [shows](#) stopping or crashing.

What's New in Version 3.1.2

- [Bug Fix](#)

Bug Fix

- [SuperStar](#) could crash at startup time. This has been fixed.

What's New in Version 3.1.0

- [Expand All and Collapse All for channel groups](#)
- [New DMX adapters supported](#)
- [Performance of ENTTEC DMX USB Pro adapters improved](#)
- [Scrunching the SuperStar sequence grid for imported visualizations](#)
- [Instant Sequencing with imported timings](#)
- [Increased limit on SuperStar's number of fixtures per prop](#)
- [SuperStar exports grouped CCR devices](#)
- [Sample SuperStar clipboard files added](#)
- [Bug fixes](#)

Expand All and Collapse All for Channel Groups

In the [Sequence Editor](#), clicking on a [channel group's](#) expander button expands or collapses the channel group - that is, it makes the channel group's children visible, or hides them. In addition to this, now you can expand or collapse the channel group and all of its descendants:

Holding the Shift key while clicking on a collapsed group will expand it and all of its descendants except for [RGB channel](#) descendants; holding both Ctrl and Shift while clicking on a collapsed group will expand it and all of its descendants including RGB channel descendants.

If the group is expanded, holding Shift (or both Ctrl and Shift) while clicking will collapse it and all of its descendants.

New DMX Adapters Supported

The LOR USB485B and the Lynx adapters are now officially supported for use as [DMX adapters](#). The LOR USB485B should use the "Raw DMX" protocol, and the Lynx should use the new "Lynx" protocol.

Performance of ENTTEC DMX USB Pro Adapters Improved

One of the [supported adapters](#) for [native DMX devices](#), the ENTTEC DMX USB Pro, is capable of offloading some CPU utilization from the computer driving the DMX devices through it. Previous versions of Light-O-Rama did not take advantage of this capability, but it does as of this version.

Scrunching the SuperStar Sequence Grid for Imported Visualizations

A new option has been added to [SuperStar's Import Visualization dialog](#), allowing you to "scrunch" the sequencing grid for your visualization. This allows you to pack the most light fixtures possible into each sequencing row. For example, if you have the 2 CCR [license level](#), and you are getting an error message saying that your visualization can only have 2 green sequencing grid rows or less during export, then you can try importing your visualization again and selecting the "Scrunch the Sequence Grid" option, then try exporting again.

Instant Sequencing with Imported Timings

Previous to this release, in [SuperStar](#), you could import timings, but could only use them for visual reference. They can now be used to create an instant sequence. You can import up to three timing channels, which will become the top three timings. After importing timings, if you open the Timing Map dialog box, you will see that the "All Freqs" row of timings has been renamed to "Imported".

Increased Limit on SuperStar's Number of Fixtures per Prop

[SuperStar's](#) limit on the number of [fixtures](#) allowed in a [prop](#) has been increased from 32 to 64. This brings the limit up to the same limit as in the [Visualizer](#).

SuperStar Exports Grouped CCR Devices

[SuperStar](#) now exports CCRs as [grouped](#) CCR devices. This makes it much easier to see the entire sequence in the [Sequence Editor](#).

Sample SuperStar Clipboard Files Added

Twenty new sample system clipboard files have been added to [SuperStar](#). Click on the Edit menu and select "Load/Save Clipboard", and you will see the new files, such as "Sys - BubblesRiseAndPop.scb", "DiamondExpanding.scb", and "Sys - SharkFinForHorizontalRibbons.scb". To use one, select it from the list, click on "Load Clipboard from File", and then click on "Paste". The effects will be pasted into your sequence starting at the time you have selected.

Bug Fixes

- When using the [Visualizer's](#) "Insert Fixture from Symbol" command, the symbol inserted may have been missing a segment from the last point defined back to the first.
- When starting a simulation in the [Visualizer](#) with more than 255 [virtual channels](#), a warning is now shown that only the first 255 will be used.
- The [Visualizer](#) now prevents errors when loading [images](#) that are too large, or starting a new simulation with a blank background that is too large. The absolute maximum size is now 2500x2500.
- If you cancelled the creation of a new visualization in the [Visualizer](#), you would incorrectly be prompted for a save filename. Since no visualization was created, there was nothing to save.
- If you loaded a file with a bad signature into the [Visualizer](#), any new file created in that session could also be marked as bad.
- Depending on the size of fonts in Windows, text in the [Visualizer's Options dialog](#) may have been cut off.
- In some situations, using certain keyboard functions (such as Ctrl-Z to [undo](#)) in the [Sequence Editor](#) would cause the display to jump to another location (such as to the bottom of the [channel list](#)).

- The [Visualizer's Channel Wizard](#) did not correctly assign channels when using the [DMX device type](#).
- In some cases, if an error occurred while the [Visualizer](#) was loading a prop file, existing [prop](#) and [fixture](#) data could be corrupted.
- [Importing a channel configuration file](#) would fail if one of the [channels](#) in the channel config file was a [subsequence](#) and that subsequence's sequence file was missing or otherwise unloadable.
- In the [Tapper Wizard](#), if "[Insert a timing into the timing grid for each tap](#)" were checked, and "[Insert effects into a channel](#)" were unchecked, and taps were collected and then applied to the [sequence](#), starting over with new taps would not be able to collect more taps than the originally collected number unless the Tapper Wizard were exited and reopened first.
- The [Sequence Editor](#) would crash if a port number greater than 32767 were entered into the [Visualizer Preferences dialog](#).
- For large audio files (for example, an audio file that is half an hour long), the [Beat Wizard](#), [VU Wizard](#), and [Waveform Display](#) would sometimes fail with an error saying that memory could not be allocated.
- In the [Sequence Editor](#), when pasting from a [saved clipboard](#) which happens to be [locked](#), the clipboard would automatically unlock.
- When exporting a file in SuperStar, if the audio file was an MP3 file, the filename would get exported as SSEditAudioFile.wav. This has been fixed to use the MP3 audio file name.
- [SuperStar's](#) effect bars in the time layer were sometimes white when they were supposed to be colored.
- In [SuperStar](#), [Light-O-Rama controllers](#) were assumed to never have more than 16 [channels](#). They can now have up to 512.
- Orange, yellow, and purple lights were not being sequenced by [SuperStar's Instant Sequence feature](#).
- [SuperStar](#) was not handling duplicate [channels](#) in a visualization (i.e. channels that are assigned to more than one light [fixture](#)). Now, they are displayed in dark gray, and cannot be selected or sequenced.
- [SuperStar](#) was not properly detecting rows in visualizations with props that do not contain any lights.
- Sometimes, not all [channels](#) in a visualization were being read properly by [SuperStar](#).
- [SuperStar](#) was not exporting macro commands when in visualization mode.
- If you load and play an audio file in [SuperStar](#), then open and play a sequence using the same audio file in the [Sequence Editor](#), you could get an error in SuperStar saying to shut down the other program. If you then shut down the Sequence Editor, and try to play the audio file again, it would not play (even if you tried to load the audio file again).
- [SuperStar's](#) Configuration Dialog box previously listed "Unit Nbr" and "Unit ID". A [controller's](#) "Unit Nbr" was the decimal number that equated to the controller's [unit ID](#) (which is a hexadecimal number). This ended up being confusing, and so now only the unit ID is listed. This is now consistent with the rest of the [Light-O-Rama software suite](#).

What's New in Version 3.0.2

- [Bug fix](#)

Bug Fix

- When the [Hardware Utility scans for connected controllers](#), it could confuse CTB16PC, CCF, and CCB100 controllers with each other.

What's New in Version 3.0.0

- [The Light-O-Rama Visualizer](#)
- [The Light-O-Rama SuperStar Sequencer](#)
- [Channel Groups](#)
- [Native DMX Devices](#)
- [Paint Sequence](#)
- [Compressed Sequences](#)
- [Variables in Windows shell commands](#)
- [New paste modes](#)
- [Dimming curves](#)
- [Hide or unhide a track by left-clicking its track bar](#)
- [Select columns or rows via the right-click context menu](#)
- [Protected sequences](#)
- [Custom keyboard maps](#)
- [Reversing pixel order in CCRs/CCBs](#)
- [Effect tools' keyboard shortcuts shown in toolbar tooltips](#)
- [Control over channel button colors while not playing](#)
- [Several view settings for sequences are now persistent](#)
- [Tools Panel can be completely hidden](#)
- [Control over channel names in "Insert Device"](#)
- [Channel names in "Insert Device" indicate network for auxiliary networks](#)
- [Subsequences changed on disk automatically reloaded](#)
- [Additional clipboard management capability](#)
- [Locking channels in tracks](#)
- [Additional info in channel button tooltips](#)
- [Sequence grid tooltips show channel color](#)
- [Time ranges in Beat Wizard and VU Wizard automatically set to play range](#)
- [VU Wizard shows percent of time above threshold](#)
- [New "Change Controller" dialog](#)
- [Add Controller dialog allows selection of network](#)
- [Additional Mouse Scroll Wheel Support](#)
- [Sequence and track names are printed](#)
- [Control Panel's menu reorganized](#)
- [Performance of "Repeat" improved](#)
- [Memory usage of undo recording improved](#)
- [Verifier speed improved for channel conflict check](#)
- ["Channel Property Grid" renamed to "Channel Configuration"](#)
- [Bug Fixes](#)

The Light-O-Rama Visualizer

The [Light-O-Rama Visualizer](#) is a new program in the [Light-O-Rama software package](#). It is intended to give a visual representation on your computer screen of how your lights will look during a [sequence](#) or during your [show](#).

Please note that the [Animator](#), which has a similar purpose, is still supported, so that existing sequences continue to work with it. However, the Visualizer is more fully featured than the Animator, so consider using the Visualizer instead of the Animator, especially for new sequences.

The Light-O-Rama SuperStar Sequencer

The [Light-O-Rama SuperStar Sequencer](#) is a new program in the [Light-O-Rama software package](#). It can be used as a sort of front end for the [Light-O-Rama Sequence Editor](#), creating sequences visually rather than via a channels-versus-time grid.

Note that existing Light-O-Rama [licenses](#) do not cover SuperStar (except in demo mode). In order to fully use SuperStar, your license will have to be upgraded to have SuperStar support.

Channel Groups

The [Insert Device dialog](#) can now optionally create devices as [channel groups](#), instead of as raw [channels](#) and/or [RGB channels](#). A channel group is a set of channels and/or RGB channels that can be collapsed down to a single row in the display, or expanded to show rows for all (or some) of its members.

Native DMX Devices

Light-O-Rama now supports control of [native DMX devices](#).

Note that only the Advanced license level supports this.

Paint Sequence

The new [Paint Sequence tool](#) can be used to paint effects from another [sequence](#) into the current sequence. This can be used to accomplish things similar to what can be accomplished with [subsequences](#), in a potentially clearer and easier way, without the extra complication of subsequences.

Compressed Sequences

It may take a significant amount of time to load a large Light-O-Rama [sequence](#). When loading one in the [Sequence Editor](#), in order to view or modify it, this may be an inconvenience, but the real issue is loading one in the [Show Player](#): When the Show Player has to load a large sequence, it may cause a noticeable pause in your [show](#) as the sequence loads.

To resolve this issue, this release of Light-O-Rama introduces the concept of [compressed sequences](#). A compressed sequence is a separate save file, associated with a sequence but containing only enough information to play the sequence in the Show Player, and optimized for loading speed. This can speed up loading times dramatically - for example, for a certain large sequence that takes eight seconds to load on a certain computer, the associated compressed sequence only takes a small fraction of a second to load on that same computer.

Variables in Windows Shell Commands

In previous versions of Light-O-Rama, the [Windows shell command](#) associated with a [sequence](#) was a static thing - it would be executed exactly as you had typed it. Now, they are instead templates; you can type in pieces that will be executed exactly as you typed them, just as before, but you can also type in [variables](#), which will be replaced with run-time information, such as the name of the song that is being played.

New Paste Modes

The [Sequence Editor](#) previously offered two different [modes for pasting](#): [paste by cell](#) and [paste by time](#). There are now two additional new modes: [stretch to fit](#) and [repeat to fit](#). Stretch to fit stretches (or compresses) the copied [effects](#) so that they fit into the area that you select, while repeat to fit repeats (or cuts off) the copied effects so that they fit into the area that you select.

Dimming Curves

Gen3 [Light-O-Rama Controllers](#), and pre-Gen3 LOR controllers with Gen3 firmware installed, support customizable dimming curves. A dimming curve determines the output of a circuit from the intensity setting sent to that circuit; for example, some pieces of hardware (such as strobe lights) should never be dimmed, and so a dimming curve can be set for such a device that sets the output at 100% for any intensity of 50% or above, and at 0% for any intensity lower than 50%. Another example is that different types of bulbs (such as incandescents versus LEDs) may naturally get brighter or dimmer at different rates when going from one intensity to another, and so different dimming curves can be used to even them out, making fades on them appear more similar to each other.

You can control what dimming curve is used for what circuit via the [Hardware Utility's](#) new [Advanced Configuration screen](#).

Hide or Unhide a Track by Left-Clicking Its Track Bar

In previous versions of the [Sequence Editor](#), both left-clicking and right-clicking on a [track's track bar](#) would cause that [track bar's popup menu](#) to open. Right-clicking still does, but left-clicking now instead [hides or unhides the track](#).

Select Columns or Rows via the Right-Click Context Menu

In previous versions of the [Sequence Editor](#), you could select an entire row or rows, or an entire column or columns, via the [Edit menu's Select Rows and Select Columns](#) menu items. Now, you can also do this via the [right-click context menu](#).

Protected Sequences

The [Sequence Editor](#) can now be used to create [protected sequences](#), which are [sequences](#) whose sequence grids cannot be viewed or (generally speaking) modified, but which can still be played, control lights, be [scheduled](#) in [shows](#), and so forth.

Control Over Channel Button Colors While Not Playing

In previous versions of the [Sequence Editor](#), while a [sequence](#) was not playing, [channel buttons](#) would be displayed as grey (or black for [RGB channels](#)). Now, it still operates that way by default, but the [Channel Button Colors submenu](#) on the [View menu](#) gives you two other options: to be displayed using the [channel's](#) full color, or to be displayed using the channel's color at the time of the start of the current selection.

Reversing Pixel Order in CCRs/CCBs

The [Hardware Utility's CCR/CCB Configuration screen](#) now supports reversing the pixel order of a Cosmic Color Device (so that pixel 50 is closest to the controller, rather than pixel 1).

Custom Keyboard Maps

The behavior of keyboard keys in the Sequence Editor can now be configured, via the new [Keyboard Preferences dialog](#).

Effect Tools' Keyboard Shortcuts Shown in Toolbar Tooltips

If one of the effect tools on the [Tools toolbar](#) has a [keyboard shortcut](#) that applies that tool, and only applies that tool, it is displayed in the tooltip for that effect tool's button on the toolbar.

Several View Settings for Sequences Are Now Persistent

In the [Sequence Editor](#), several view settings for [sequences](#) are now persistent. That is, for example, if you change the width of the [channel buttons](#) for a sequence, they will automatically be that size whenever you open that sequence in the future (unless you explicitly change their size again).

This information is automatically remembered outside of the sequence file itself (but associated with it), so you do not have to save the sequence file when you make a change to such a setting. Also, there had been some such settings which already were persistent, but used the sequence file, so that you would have to save the sequence whenever you altered them; these now are instead automatically persisted outside of the sequence file.

The following view settings are now persisted in this manner:

- The width of the channel buttons
- Whether the channel buttons are displayed or not
- The [height of a row of the grid](#) (and of the channel buttons)
- The [width of the grid per unit of time](#)
- The [zoom setting](#) of the [Animator](#)
- Whether the [Animator's controls are shown or hidden](#)
- The [zoom level](#) of the [waveform display](#)

Tools Panel Can Be Completely Hidden

The [Sequence Editor's Tools Panel](#) can now be completely hidden, so that not even the narrow bar with its wrench icon is displayed, via "[Tools Panel](#)" on the [View menu](#).

Control Over Channel Names in "Insert Device"

The [Sequence Editor's Insert Device](#) dialog used to give no control over the names of the [channels](#) that it would create. You can now specify the base name (such as changing the default "SD" for a Servo Dog device to "Animatronic Rudolph", resulting in channel names like "Animatronic Rudolph 03.7" for [unit 03 circuit 7](#) instead of "SD 03.7"). You can also specify that the unit ID should not be included at all (resulting, for example, in "Animatronic Rudolph 7" for circuit 7).

Channel Names in "Insert Device" Indicate Network for Auxiliary Networks

When creating [channels](#), the [Sequence Editor's Insert Device](#) dialog would not include any indication of the channel's [network](#) in the channel's name. For example, a channel for [unit 03 circuit 7](#) of a Servo Dog device would be called "SD 03.7" no matter what network it was on. Now, if the channel is on an auxiliary network, it will additionally include that network's identifier. For example, "SD C03.7" would indicate that the channel is on the Aux C network, while a plain "SD 03.7" would indicate that the channel is on the regular network.

Subsequences Changed on Disk Automatically Reloaded

If a [sequence](#) containing a [subsequence](#) was loaded, and then the subsequence was changed and

saved, and the parent sequence then played, it would play as if the subsequence had not been changed. It will now instead play using the newly saved contents of the subsequence.

Additional Clipboard Management Capability

In previous versions of the [Sequence Editor](#), if a saved [clipboard](#) were changed, the changes would automatically be resaved when the Sequence Editor was closed. This is still done, but there is now a new menu item on a clipboard's popup menu to manually resave it, and an option on the [Clipboard Preferences](#) menu to automatically resave. Similarly, there is now a new menu item to reload a saved sequence (in case the contents of its save file were changed outside of the Sequence Editor), and an option on the Clipboard Preferences menu to do so automatically. These changes are intended to ease the use of clipboards by third party tools.

Additionally, a new menu item to remove a clipboard from the list of clipboards has been added.

Locking Channels in Tracks

The [channels](#) of a [track](#) can now be locked, meaning that you will be unable to add channels to the track, remove channels from it, move channels within it, or modify settings (such as device type and unit) within it, unless you unlock the track first. To lock or unlock a track, use "[Lock Track](#)" (or "Unlock Track") from the [track bar's popup menu](#).

Additional Info in Channel Button Tooltips

In previous versions of the [Sequence Editor](#), the tooltip that would open when the mouse hovered over a [channel button](#) would show the name of the [channel](#). It now shows additional information, such as the [unit](#) and [circuit](#).

Sequence Grid Tooltips Show Channel Button Color

In the [Sequence Editor](#), the tooltip that opens when the mouse is hovered over the sequence grid now displays the color of the [channel](#) of the row that the mouse is hovering over.

This new behavior can be turned off via "[Use Channel Colors](#)" in the [Display Preferences dialog](#).

Time Ranges in Beat Wizard and VU Wizard Automatically Set to Play Range

In previous versions of the [Sequence Editor](#), when the [Beat Wizard](#) or [VU Wizard](#) was opened, it would automatically be set to operate on "[the entire song](#)". It will now instead be automatically set to operate on the play range (the [freeform play range](#) if one exists, or the [play range](#) as set on the [Play menu](#) if not).

Note: This behavior can be overridden, for these wizards and also the [Tapper Wizard](#), via the "[Use Play Range for Wizards](#)" option on the [Play Preferences dialog](#). If this option is not enabled, then the wizards will default to using the time range of the entire song.

VU Wizard Shows Percent of Time above Threshold

The [VU Wizard](#) now displays the percent of time that is above the specified threshold, with the specified settings.

New "Change Controller" dialog

The new [Change Controller dialog](#) (which can be accessed from the [Channel Configuration screen](#)) presents a list of the [controllers](#) in a [track](#), and allows you to select one and change its physical settings. For example, you could use this dialog to quickly change all [channels](#) for the [Light-O-Rama controller](#) 03 on the Regular [network](#) to instead be controller 07 on the Aux C network. *Note: The "Channel Configuration" screen used to be known as the Channel Property Grid.*

Add Controller Dialog Allows Selection of Network

The [Channel Configuration screen's Add Controller dialog](#) now allows the [network](#) of the [controller](#) to be selected (for those device types that have networks). *Note: The "Channel Configuration" screen used to be known as the Channel Property Grid.*

Additional Mouse Scroll Wheel Support

The mouse scroll wheel is now supported in the [Schedule Editor](#) and in the [Sequence Editor's Channel Configuration screen](#). *Note: The "Channel Configuration" screen used to be known as the Channel Property Grid.*

Sequence and Track Names are Printed

When the "Print" function is used in the [Sequence Editor's Channel Configuration screen](#), the printout now includes the name of the [sequence](#) and of the [track](#). *Note: The "Channel Configuration" screen used to be known as the Channel Property Grid.*

Control Panel's Menu Reorganized

In previous versions of the [Light-O-Rama Control Panel](#), some of the menu items on its [popup menu](#) were paired with each other. For example, to control whether or not the Control Panel should be automatically launched whenever the computer starts up, there was a "Launch at startup" menu item and also a "Do not launch at startup" menu item. This could be a bit confusing, as the way that you could tell (for example) that the Control Panel would be launched at startup was that the "Launch at startup" menu item was greyed out, so that you couldn't select it.

Now, instead, such pairs have been replaced by single menu items, which can be checked or unchecked. For example, if "Launch at startup" is checked, the Control Panel will launch at startup, and if it is not, it will not; there is no longer any "Do not launch at startup" menu item.

Performance of "Repeat" Improved

The [Sequence Editor's "Repeat"](#) function is now quicker than it used to be, and also uses less memory than it did.

Memory Usage of Undo Recording Improved

The [Sequence Editor](#) now uses significantly less memory than it used to in order to record events for later [undoing/redoing](#).

Verifier Speed Improved for Channel Conflict Check

[One of the possible issues](#) that the [Light-O-Rama Verifier](#) can check for is whether a [sequence](#) has two different [channels](#) with the same physical settings (such as [unit](#) and [circuit](#)). In the past, this

check could take quite a while to perform on large sequences; it has now been speeded up considerably. For example, for a certain sequence, the Verifier running on a certain computer would need ten minutes to perform this check. It now needs only about a second, for the same sequence on the same computer.

"Channel Property Grid" Renamed to "Channel Configuration"

The Channel Property Grid has been renamed to "[Channel Configuration](#)".

Bug Fixes

- The tooltip for the [Sequence Editor's "Custom Shimmer"](#) button was inappropriately labeled.
- If multiple [sequences](#) were open in the [Sequence Editor](#), and they were not maximized, switching from one sequence to another by directly clicking on a sequence would correctly activate that sequence, but would not update the row of sequence tabs to show that that sequence is now active.
- A bug in an earlier Beta release of the software, which was not released to the general public, would sometimes cause a [sequence](#) to accumulate "extra" [RGB channels](#), which were not present in any of the sequence's [tracks](#). These RGB channels weren't noticeable to a user, and they would not affect the behavior of the lights, but their presence in a sequence could cause certain operations, such as deleting channels, to be much slower than normal, for that particular sequence. Such operations have now been sped up.
- [Clipboards](#) that were loaded from saved clipboard files would always paste as if "[Paste from foreground](#)" was enabled.
- If both the [Sequence Editor](#) and the active [sequence](#) were maximized, and neither vertical scroll bar (the one to scroll between [tracks](#) and the one to scroll within a track) were present, and the program was running on the rightmost monitor, then when selecting an area by clicking and dragging, you would be unable to scroll to the right while selecting.
- When loading a [clipboard](#), if you selected the clipboard file's name by double clicking it in the file browsing dialog, and the mouse happened to be over a [sequence](#), then after the clipboard loaded, a phantom mouse click would be applied to the sequence. So, for example, if the [Fade Up tool](#) was selected, a [fade up](#) would be applied to the spot on the sequence where your mouse happened to be.
- The [Delete Controller dialog](#) used to be unable to distinguish between different [LOR controllers](#) that happen to have the same [unit ID](#) on different [networks](#).
- If a [show](#) has a [jukebox interactive group](#), and the trigger associated with that group is pushed while a [sequence](#) from that group is playing, the trigger should not cause the sequence to be interrupted and the next sequence in the group to be played. This worked fine. However, it would cause the sequence that is considered to be "next" to be changed. For example, if the group contains three sequences, A, B, and C, and A is playing when the trigger is pushed, A would continue playing (as it should), but after A ended, if the trigger were pushed again, C, not B, would play.
- When [creating](#) a new [musical sequence](#), if you set the number of [channels](#) to zero, and then specify that the channels should be created via a [channel configuration file](#) instead of via the specified number of channels, the [Sequence Editor](#) would tell you that you need to specify more than zero channels, and then crash.
- In the [Sequence Editor](#), when the time range of a [track](#) is scrolled, the time ranges of any other tracks in the [sequence](#) should scroll with it. However, this did not occur unless those other tracks had already been displayed at least once since the sequence was loaded or created. It also would not occur during play except when those other tracks were displayed.
- On the [Hardware Utility's LOR MP3 tab](#), if no MP3 controller were connected, the "Set" button (to set the unit's time) should be greyed out. In most cases, it was, but if no comm port existed (as opposed to merely no comm port being selected) it was not greyed out, and so could be pushed.

- Pushing it in such a situation would result in a crash of the Hardware Utility.
- When the [track](#) list of a [sequence](#) is changed in the [Sequence Editor](#) - for example, if a track is [moved](#) to another position - any tracks that had been [hidden](#) would automatically unhide.
 - In the [Sequence Editor](#), when a file was chosen from a file browsing dialog by double clicking on the file, sometimes the sequence grid that was "beneath" the dialog would act as if it had been clicked. For example, an [effect](#) tool might be applied to the grid, or a [Channel Settings dialog](#) would open.
 - If a [track](#) was [hidden](#), moving it up in the list of tracks would cause it to become the first displayed track.
 - If a [clipboard](#) was saved in the [Sequence Editor](#), and the clipboard's name was invalid in certain ways, the Sequence Editor would crash.
 - If an iDMX1000 controller was selected in the [Hardware Utility's Test Console](#), the "Current Channel Range" display would be incorrect.
 - The "[Move to Track Number...](#)" menu item on a [channel button's popup menu](#) was enabled even if there was only one [track](#).

What's New in Version 2.9.4

- [Up to sixteen Light-O-Rama networks supported](#)
- [Old MC-P only affects the Regular Light-O-Rama network](#)
- [Feedback for attempting to copy or cut to a locked clipboard](#)
- [Vary color of channel button fonts](#)
- [Unqualified file name used on Sequence Editor tabs](#)
- [Standalone sequences no longer download commands for auxiliary networks](#)
- [Bug Fixes](#)

Up to Sixteen Light-O-Rama Networks Supported

Previous versions of Light-O-Rama could support [Light-O-Rama controllers](#) on up to four different [networks](#) ("Regular", "Aux A", "Aux B", and "Aux C"). This has been increased to sixteen (in addition to the original four, "Aux D" through "Aux O").

Old MC-P Only Affects the Regular Light-O-Rama Network

[Old MC-P compatibility mode](#) is required if you have certain old [Light-O-Rama controllers](#) (MC-P controllers purchased prior to November 15, 2003). This compatibility mode causes significant overhead on the communications protocol. In previous versions of Light-O-Rama, if you turned on Old MC-P compatibility mode, it would affect all of your Light-O-Rama [networks](#). Now, instead, it only affects the Regular Light-O-Rama network; it does not affect any auxiliary Light-O-Rama networks. So, you can now put all of your old MC-P controllers on the Regular network, and your other controllers on other networks, so that they are not affected by the communications protocol overhead.

Feedback for Attempting to Copy or Cut to a Locked Clipboard

In the [Sequence Editor](#), if the currently selected [clipboard](#) is [locked](#), [copying or cutting](#) does nothing. This is so as to avoid accidentally overwriting the data on a clipboard that you want to keep. However, there is nothing stopping you from hitting "Ctrl-C" or "Ctrl-X", attempting to copy or cut, and in previous versions of Light-O-Rama, doing so would give you no indication that something was amiss until you later attempted to paste, and wound up pasting whatever had previously been on the clipboard, instead of what you thought you had just copied or cut. Now, the Sequence Editor will beep, to indicate that the attempted copy or cut did not take effect.

Vary Color of Channel Button Fonts

In the [Sequence Editor](#), you can control whether or not the color of [channel buttons](#) changes during play (based upon the [lighting effects](#) happening on those [channels](#)). In early versions of Light-O-Rama, the text on the buttons was always black, and stayed black no matter what, which meant that sometimes the text was not readable.

In a relatively recent release, this was changed so that the color could be either black or white, depending upon which gives a more readable contrast with the background color of the button itself. However, some users found it to be distracting when a channel button's font would switch between black and white during play, and so you can now control whether or not this happens.

You can control it temporarily (until the next time the Sequence Editor is started) via the [Vary Color of Channel Button Fonts](#) item on the [Play menu](#), or set your default preference (which will take effect every time the Sequence Editor is started) via [Also vary their font colors](#) on the [Play Preferences dialog](#).

Unqualified File Name Used on Sequence Editor Tabs

When the [Sequence Editor](#) has multiple [sequences](#) open, it displays a tab strip across the top, with one tab per sequence. Each tab has the name of an open sequence; clicking on a tab causes that sequence to be displayed. In previous versions, the name of the sequence would include its directory name, if the sequence was not stored in the default directory for sequences. This could lead to some very wide tabs. Now, only the unqualified filename, without any directory information, is displayed.

The fully qualified filename can still be found via "[Sequence Info](#)", on the [View menu](#).

Standalone Sequences No Longer Download Commands for Auxiliary Networks

If a [sequence](#) that used multiple [Light-O-Rama networks](#) was downloaded to a standalone [controller](#) (via the [Hardware Utility's MP3 tab](#) or via the [Simple Show Builder](#)), previous versions of Light-O-Rama would warn you of that fact, because standalone controllers only send commands out over a single comm line, and therefore the multiple networks would all get amalgamated into a single one when downloaded. Now, instead, only commands for controllers on the Regular Light-O-Rama network are downloaded.

Bug Fixes

- The [Hardware Utility](#) previously used [Old MC-P compatibility mode](#) when it should have not done so, and did not use it when it should have.
- On some computers, the [Clipboards panel](#) would not show its full height, leading to most of its functionality being unavailable due to being offscreen.
- Downloading large [sequences](#) for standalone [controllers](#), such as via the [Hardware Utility's MP3 tab](#), was much slower than it had been; its speed has now been increased.
- Depending upon how Windows is set up, the [LOR Control Panel](#) would sometimes be unable to launch the various other LOR applications (such as the [Show Player](#)).
- The [Hardware Utility](#) and [Simple Show Builder](#) would previously allow you to download any type of media file for a [standalone sequence](#), such as WAV files or WMA files, despite the fact that only MP3 files are supported by the [controllers](#). They will now give an error message if you attempt to download a media file other than an MP3 file.

What's New in Version 2.8.12

- [Sequence Editor Can Keep Lights On at End of Play, and Turn Them Off Manually](#)
- [Bug Fixes](#)

Sequence Editor Can Keep Lights On at End Of Play, and Turn Them Off Manually

In previous versions of Light-O-Rama, the [Sequence Editor](#) would automatically turn off all lights in a [sequence](#) when that sequence finished playing. It can now optionally keep them turned on, via the new "[Lights Off at End](#)" menu item in the [Play menu](#). The lights can subsequently be turned off manually via "[Lights Off Now](#)".

Bug Fixes

- If, while [importing a channel configuration file](#), you double-clicked the channel configuration's filename in the file browsing dialog, and if your mouse was over a sequence grid at the time, then after the file was imported, depending upon where your mouse was, this could have caused the grid to behave as if you clicked your mouse on it. For example, if you were over a [channel button](#), the [Channel Settings dialog](#) for that [channel](#) could have opened.
- If [DMX effects](#) were used in a [sequence](#), and the [Sequence Editor's Vary Color of Channel Buttons](#) setting was turned on, then during play, for certain DMX effects, the sequence grid could temporarily go blank as displayed in the Sequence Editor (though the behaviour of your actual lights would not be adversely affected).
- In certain situations, such as after an [undo](#), the selected [channel](#) from the channel dropdown list in the [Animator](#) would spontaneously change to being the first channel in the list.
- If you manually edited certain registry settings related to disk file paths (note: doing this is not recommended) which Light-O-Rama normally sets itself, leaving off a backslash at their ends would lead to unexpected results.
- If an [RGB channel](#) (as opposed to one of its constituent [channels](#)) was used to draw in the [Animator](#), and that RGB channel was deleted from the [sequence](#), the cells of the Animator using that RGB channel would not be blanked out.
- If a constituent [channel](#) of an [RGB channel](#) (as opposed to the RGB channel itself) was used to draw in the [Animator](#), then in certain situations, the cells of the Animator using that constituent channel could have been blanked out inadvertently.
- In certain situations, very small [fades](#) (for example 0% to 1%) over relatively long spans of time would cause other [effects](#) to spontaneously appear on the [channel](#).
- The [Color Fade tool](#) would give an option to insert [DMX effects](#) even if [DMX editing was disabled](#).
- If the [Color Fade tool](#) was used to make [DMX effects](#), and those DMX effects were themselves fades, they would not be sent to the controllers. They now are sent, but (as of the time of this writing) LOR hardware does not support fading DMX effects, and so they are converted to regular fades.

What's New in Version 2.8.10

- [The Advanced OpenGL Settings Dialog](#)
- [Bug Fixes](#)

The Advanced OpenGL Settings Dialog

The new [Advanced OpenGL Settings dialog](#) can be used, experimentally, to try to investigate or work around strange graphics issues. However, this is not recommended; such problems can typically be better resolved in other ways, such as updating your computer's graphics card's drivers.

Bug Fixes

- The [Set Paste Mode submenu](#) in the [Sequence Editor's Edit menu](#) did not have a shortcut key associated with its [Paste from Foreground](#) option.
- On some computers, selecting a [sequence](#) from the [Sequence Editor's Windows menu](#) would cause a portion of the display to remain showing the previous sequence, until something like a [refresh](#) was done.
- When the [Chase tool](#) was used with [Paste from Foreground](#) turned off, and the chase was done either from the bottom left to the top right or vice versa, in some cases it would not properly overwrite existing [effects](#) outside of the actual things being chased with [off effects](#).
- The "+" key is supposed to invoke the [Repeat](#) tool, but only the "+" key on the standard part of the keyboard was doing so, while the "+" key on the numeric keypad did nothing.
- When more than one [sequence](#) was open in the [Sequence Editor](#), and they were maximized, clicking on the "X" to the right of the [menu bar](#) would close the active sequence (as it should), but that sequence's tab would remain open in the row of sequence tabs. Subsequently clicking on that tab, for the closed sequence, would cause the Sequence Editor to crash.
- Stopping play of a [sequence](#) in the [Sequence Editor](#) would sometimes cause the column of cells that happened to be at the time of the start of play to become selected.

What's New in Version 2.8.8

- [Bug Fixes](#)

Bug Fixes

- Various things in [the Animator](#), such as drawing and erasing, were much slower than normal.
- When a [sequence](#) was loaded, [the Animator](#) would not remember whether its controls were [hidden](#) for that sequence or not.
- Attempting to [write](#) a [musical sequence](#) to an SD card (for a standalone controller) would result in a "subscript out of range" error message.

What's New in Version 2.8.6

- [RGB Channels](#)
- [Color Fade Tool](#)
- [Repeat Tool](#)
- [Intelligent Fade Tool](#)
- [Fill Tool](#)
- [Chase Tool](#)
- [Paste from Foreground](#)
- [Insert Device](#)
- [Tools Panel](#)
- [Recent Tools](#)
- [Saved Tools](#)
- [Clipboards](#)
- [Sequences Created with Equally Spaced Timings in Freeform Grids](#)
- [Select Multiple Files in the Hardware Utility's MP3 Tab](#)
- [Tabbed Sequences Display](#)

- [Tools Menu Hotkeys Changed](#)
- [Keyboard Editing Keys Changed](#)
- [Off Effect via Delete Key](#)
- [Keyboard's Background/Foreground Selectors' Behavior Changed](#)
- [Shimmer and Twinkle Display Update](#)
- [Text of Channel Buttons Changes Color During Play](#)
- [Offline Registration Utility](#)
- [Bug Fixes](#)

RGB Channels

An [RGB channel](#) represents a light or string of lights that can change colors - for example, a pixel on a Cosmic Color Ribbon. It consists of three "normal" [channels](#), representing the three component colors - red, green and blue. Previously, to sequence such a device, you would have to sequence those three channels for the three component colors individually - that is, you would set up the [sequence](#) to have those three channels, and you would (for example) set the red channel to fade up, the green channel to hold steady, and the blue channel to fade down.

Now, you still can sequence the three component channels individually, but instead you could simply add an "RGB channel" to the sequence, and use it to deal more directly with the resulting colors. For example, instead of telling the red channel to fade up, the green channel to hold steady, and the blue channel to fade down, you would simply tell the RGB channel to fade from cyan to yellow.

Color Fade Tool

The [Color Fade](#) tool is a new tool that can be used to tell [RGB channels](#) how to behave. For example, to specify that the RGB channel should fade from cyan to yellow over a certain time range in a sequence, you would select the Color Fade tool, with its colors set to cyan and yellow, and apply the tool to that time range of the sequence.

The Color Fade tool can also be used to do [fills](#), by clicking the selected area instead of clicking and dragging.

Repeat Tool

The [Repeat tool](#) takes whatever is contained in the selected area of the [sequence](#) and makes a new copy of it immediately following the selected area. Using the tool again (without changing what area of the sequence has been selected) will make another new copy immediately following the first, and using it again will make a third new copy immediately following the second. This can be repeated as many times as you like, making as many back-to-back copies of the selected area as you want.

Intelligent Fade Tool

The [Intelligent Fade tool](#) is similar to the [Fade Up](#) and [Fade Down tools](#). However, using it makes *either* a fade up *or* a fade down, depending upon whether you click and drag left to right or right to left.

It can also be used to do [fills](#), by clicking the selected area instead of clicking and dragging.

Fill Tool

If you apply the [Fill tool](#) to an area that has no [effects](#) (i.e. the lights are off in that [channel](#) at that time), it will automatically make a [fade](#) from the intensity that precedes the empty area to the intensity that follows the empty area. For example, if there is a fade up from 0 to 75, followed by the lights being off, followed by a fade down from 50 to 25, and you apply the Fill tool to the area where the lights are off, it will change that area so that it becomes a fade down from 75 to 50.

The Fill tool can also be used in a similar way on [RGB channels](#), where it will change an empty area so that it fades from the color preceding the empty area to the color following the empty area.

The Fill tool behaves a little differently than most other tools. With most tools, if you click and drag an area, that area will be selected, and when you let up on the mouse button, that tool will be applied to the selected area. The Fill tool, however, does not select an area, and it is applied as soon as you click, and as soon as you drag to a new area, too. This, combined with the fact that the Fill tool does nothing if it's used on an area that already has an effect, hopefully makes it quick and easy to fill a large and complicated area of the sequence just by clicking once and dragging around to the appropriate spots without letting go of the mouse button.

Chase Tool

The [Chase tool](#) takes a pattern and "chases" it through the selected area. That is, when you click on a spot in the [sequence](#), and then drag through other [channels](#) and through time, then when you let go of the mouse button, it will take the pattern in the selected area's corner where you initially clicked and copy it through the remaining channels in the selection, offsetting it a little bit in time with each subsequent channel.

Paste from Foreground

"[Paste from Foreground](#)" is a new pasting option. When it is turned on, any portions of the [clipboard's](#) copy buffer that have "[off](#)" [effects](#) won't actually be pasted when you select "[Paste](#)". That is, copied "off" effects won't overwrite what you already have in your [sequence](#).

Insert Device

The [channel button popup menu](#) now gives a new way to add [channels](#) to a [sequence](#): "[Add Device](#)". When this is selected, a [dialog](#) will open asking the type of [device](#) to add (such as an LOR/CTB 16 or a Cosmic Color Ribbon) and some settings for that device (such as its [unit ID](#)). The appropriate number of channels will then be added to the sequence, and they will automatically be populated with the appropriate unit IDs, [circuit IDs](#), and so forth.

Tools Panel

The left-hand side of the [Sequence Editor](#) now has a new [Tools Panel](#), with a few subpanels ("[Saved Tools](#)", "[Recent Tools](#)" and "[Clipboards](#)"). The panel can be pinned to the display so that it is always open, or it can be hidden so that it appears only as a small tab on the left of the Sequence Editor, with the full panel sliding out when the mouse goes over that tab. The individual subpanels can also be collapsed or expanded.

Recent Tools

The [Recent Tools](#) subpanel of the [Tools Panel](#) on the left-hand side of the [Sequence Editor](#) shows buttons representing the [tools](#) that were used recently (such as "[Fade Up 25-75](#)", "[Shimmer Down 100-0](#)", or a [color fade](#)). Clicking on one of the buttons will make that tool the currently active tool.

Not all tools are put on the Recent Tools subpanel's list; only those that would take more than one mouse click to activate are put there. For example, "[Toggle](#)" and "[Shimmer](#)" do not get put on the list, since you could activate those in a single mouseclick (from the Tools toolbar).

Right-clicking on a tool's button enables you to put the tool on the [Saved Tools](#) list.

Saved Tools

The [Saved Tools](#) subpanel of the [Tools Panel](#) on the left-hand side of the [Sequence Editor](#) is similar to the [Recent Tools](#) subpanel, except that it shows only those [tools](#) that you have decided to save. Once you put a tool on the Saved Tools list, it will remain there (until you explicitly remove it), even after the Sequence Editor has been stopped and restarted.

Clipboards

In previous versions of the [Sequence Editor](#), there was only a single [clipboard](#) for copying and pasting. Now, the Sequence Editor *starts* with a single clipboard, but you can easily [add more of them](#), and quickly switch between which one is in use at the moment, using the new [Clipboards subpanel](#) of the [Tools Panel](#) on the left-hand side of the Sequence Editor. That is, you now can have several different things copied at the same time, all of which can be pasted into your sequence.

The Clipboards subpanel also allows you to [save a clipboard](#), so that its contents will be available to be pasted even after you stop and restart the Sequence Editor, and to [lock a clipboard](#), so that it cannot be copied to (but still can be pasted from), to prevent accidental overwriting of a clipboard that you want to keep.

It also allows quick access to pasting options such as [Paste by Cell](#), [Paste by Time](#), and [Paste from Foreground](#).

Sequences Created with Equally Spaced Timings in Freeform Grids

Previously, if you chose to create a [sequence](#) with equally spaced [timings](#) (such as "a timing every tenth of a second"), the sequence's first [timing grid](#) would be a [fixed timing grid](#). You can now optionally make it either a fixed timing grid or a [freeform timing grid](#).

Select Multiple Files in the Hardware Utility's MP3 Tab

You can now select multiple files simultaneously in the [Hardware Utility's MP3 tab](#) (by using standard Windows methods, such as Shift-click).

Tabbed Sequences Display

When more than one [sequence](#) is open, the [Sequence Editor](#) now shows a single one of them, maximized, with tabs across the top having the names of the open sequences. Selecting any particular tab will cause the Sequence Editor to switch to display that sequence.

If you want to see multiple sequences at once, you can unmaximize the currently displayed sequence.

Tools Menu Hotkeys Changed

Several hotkeys for various menu items on the [Tools menu](#) have been changed, to try to minimize overlap and to give unique hotkeys to as many "high profile" tools as possible.

Keyboard Editing Keys Changed

The keys assigned to several [keyboard editing](#) shortcuts have been changed, to make room for new functions (such as the [Chase tool](#) and [Fill tool](#)).

Off Effect via Delete Key

One changed keyboard editing shortcut which it is worth explicitly pointing out (because it has been requested by several people) is that the Delete key will now apply the "[Off](#)" tool to the selected area.

Keyboard's Background/Foreground Selectors' Behavior Changed

Previously, [background and foreground effects mode](#) could be enabled by certain keystrokes. To turn them off, there was a different keystroke for enabling "regular" effects. Now, instead of keystrokes to enable those modes, there are keystrokes to toggle them between being enabled and disabled.

Shimmer and Twinkle Display Update

In the sequence grid, [shimmer](#) and [twinkle](#) effects are now displayed as a little heavier than they used to be, to hopefully make them more easily recognized.

Note that this change is only from the point of view of how they look displayed on your screen in the [Sequence Editor](#); their behavior on your actual lights is unchanged from what it was before.

Text of Channel Buttons Changes Color During Play

During play, the [Sequence Editor](#) can be set up to change the colors of [channel buttons](#) to represent the current intensity of the associated [channel](#). The text of the channel name on that channel button, however, was always black. Depending upon the color of the channel and its current intensity, this could sometimes make the button difficult or even impossible to read. Now, the color of the text of a button will be either black or white, depending upon which would be easier to read at that moment for that channel.

Offline Registration Utility

Previously, if a user had a computer that was not connected to the internet, they could only register that computer by calling in to Light-O-Rama Customer Support. LOR Customer Support had a program called the "[Offline Registration Utility](#)" which they then used to get the user's computer activated.

This program is now distributed by the LOR installer, along with all the other programs (such as the Sequence Editor). So, if a customer has two machines, one of which is connected to the internet but the other of which is not, they can register their offline computer by using the Offline Registration Utility on the *online* computer, without calling in to LOR Customer Support.

Offline registration via LOR Customer Support is still available, in case (for example) the customer has only one computer, and it is not connected to the internet.

Bug Fixes

- In the [Sequence Editor](#), when "Paste by Cell" was set, and a [copy and paste](#) was done including an [event](#) that was not completely coincident with a cell, in some situations the events pasted wouldn't appropriately match the events copied completely.
- In the [Sequence Editor](#), dragging a [channel button](#) in order to move that [channel](#) would not work properly if the visible channel range was scrolled up or down while dragging.
- Various issues were fixed when converting a [sequence](#) from being a [musical sequence](#) to an [animation sequence](#), and vice versa.
- When the [DMX Tool](#), [Fade Tool](#) or [Intensity Tool](#) windows were closed by clicking on their "X" buttons, the next time that they were displayed, they would be displayed in an entirely new location instead of in the spot where they had been when they were closed.
- The "Paste" button on the [Sequence Editor's toolbar](#) would not be enabled until after a [copy](#) (as opposed to a [cut](#)) had been done. That is, if you started up the Sequence Editor and immediately did a cut, the Paste button would still be greyed out even though you had cut something.
- If you double-clicked somewhere on the [New and Open dialog](#), for example to open a [sequence](#) by double-clicking its filename, then depending upon where your mouse was, when the dialog closed and the sequence opened, it could have caused something to happen such as a [channel's settings dialog](#) being opened, or the current [tool](#) being applied to a cell in the sequence.

What's New in Version 2.7.6

This version fixes the following bugs:

- The [Schedule Editor](#) only displayed a thin portion of its vertical scroll bar.
- In certain situations, the [Sequence Editor](#) could possibly crash after having [undone](#) the [adding of timings](#).

What's New in Version 2.7.4

- [Show on demand](#)
- [Show Player can preload sequences](#)
- [Shows can be shut down gracefully](#)
- [LOR Control Panel improvements](#)
- [Shuffle mode options](#)
- [Maximum Light-O-Rama circuit number is now 512](#)
- [New iDMX1000 firmware: version 1.41](#)
- [New DIO32 firmware:version 1.30](#)
- [New DC-MP3 firmware: version 4.10](#)
- [Bug fixes](#)

Show On Demand

You can now cause a [show](#) to be played without having [scheduled](#) it. This is done via the "[Show On Demand](#)" menu item of the [Light-O-Rama Control Panel's popup menu](#).

Please note that this feature is available only for license levels Basic Plus and higher.

Show Player Can Preload Sequences

In previous versions of Light-O-Rama, when the [Show Player](#) played a [show](#), a [sequence](#) in that show would not be loaded until the first time it was used in the show. Depending upon the size of

the sequence and the power of the computer, it could take a human-noticeable amount of time to load a sequence, so this could lead to undesired delays between sequences (the first time they are played during a given run of a show).

This is still the default behavior, but you can now optionally [set the show to preload sequences](#), so that they will all be loaded as the first step in the show, before any of them are played.

Shows Can Be Shut Down Gracefully

In previous versions of Light-O-Rama, selecting "Disable Shows" from the [Light-O-Rama Control Panel's menu](#) would cause the currently running [show](#) to stop immediately, abruptly stopping any [sequences](#) that happened to be playing. This can still be done (by selecting "[Disable Shows Immediately](#)"), but you can now shut down a show gracefully instead (by selecting "[Disable Shows Gracefully](#)").

This will cause the show that happens to be playing (if any) to be put into shutdown mode; any song that happens to be playing will be allowed to finish, after which the show's [Shutdown section](#) will run. When the Shutdown section finishes, the show will stop, and shows will be disabled.

LOR Control Panel Improvements

Several improvements were made to the [Light-O-Rama Control Panel](#):

- The "Current" and "Scheduled" sections of its [status window](#) were often mostly redundant (if the currently playing [show](#) was the show that was [scheduled](#) to be playing at the current time). The "Scheduled" section has now been replaced by a "Next" section, which shows what will happen after the current show.
- Those sections would update only after a noticeable delay of several seconds. They now update in a much more real-time fashion.
- Similarly, the first log messages that were displayed would be delayed; they are now real-time.
- The Control Panel's light bulb icon in the system tray now is different colors depending upon the state of the system: If [scheduled shows](#) are enabled, it is blue; if they are disabled, but [shows on demand](#) are enabled, it is orange; if shows are disabled entirely, it is red.
- Several new log messages were added, hopefully giving a more informative view into what the [Show Player](#) is doing.

Shuffle Mode Options

In previous versions of Light-O-Rama, when the [Musical Section](#) of a [show](#) was set to shuffle the [sequences](#) instead of playing them in order, any sequence could be randomly chosen to play at any time. This meant that, for example, the same sequence could play twice (or more) in a row, or some particular sequence could be played a second time before some other particular sequence was played even once.

The [Show Editor](#) now allows you to control the way that sequences are shuffled: You can choose whether or not a single sequence is allowed to be played twice in a row, and you can choose whether or not all sequences must be played once before some sequence is played a second time.

Existing show files will continue to behave in the same manner as they did before (unless and until you change their settings): a sequence can be repeated back-to-back, and can be played a second time before all other sequences have been played once.

The default for new shows is exactly the opposite: no sequence will be played twice in a row, and no

sequence will be played a second time before all sequences have been played once.

Maximum Light-O-Rama Circuit Number Is Now 512

In previous versions of Light-O-Rama, the maximum allowable [circuit number](#) for a [Light-O-Rama controller](#) was 256. It is now 512. At the present time, this is primarily useful for controlling DMX devices.

New iDMX1000 Firmware: Version 1.41

A new version of the firmware for the iDMX1000 has been released (version 1.41). It contains the following enhancements:

- It now has native address support (i.e. there is no longer a need for multiple unit IDs for a single iDMX1000). The old method of having a single iDMX1000 use multiple unit IDs is still supported, as "legacy mode". An iDMX1000 will be in native mode or legacy mode depending upon the unit ID it is set to: If its unit ID ends in a "0" (such as "10", "20", or "30"), it will be in legacy mode, where it actually uses sixteen unit IDs of sixteen channels each (e.g. setting the unit ID to 10 will cause it to use unit IDs 10 through 19 and 1A through 1F). If its unit ID ends in anything other than a zero, it will use only that single unit ID, but it will support all its channels on that single unit ID.
- Previously, only DMX addresses up to 256 were supported. Now, addresses up to 512 are supported (but only in native mode).
- Previously, only 64 "intelligent channels" were supported at a time - i.e. only 64 channels could simultaneously be doing shimmers, twinkles, and/or fades. Now, 128 intelligent channels are supported at a time.

New DIO32 Firmware: Version 1.30

A new version of the firmware for the DIO32 motherboard has been released (version 1.30). This version adds native address support - that is, there is no longer a need to use multiple unit IDs for a single DIO32; it can now support all channels on a single unit ID.

Please note that in order to take advantage of this new functionality, you will not only have to use the new firmware, but you will also have to change a jumper on the board which tells it whether to operate in native mode or legacy mode. Please refer to your DIO32 documentation for details.

New DC-MP3 Firmware: Version 4.10

A new version of the firmware for the DC-MP3 has been released (version 4.10). It contains the following enhancements and fixes:

- Previously, an individual sequence could only last for up to ten minutes. It can now last up to 44 hours.
- Previously, only certain manufacturer's SD cards were supported. A much larger variety is now supported (list to be compiled - although it will more likely be a list of unsupported cards rather than a list of supported cards).
- Support for SD cards with the FAT32 file system was added.
- Support for SDHC (high capacity) SD cards was added.
- Previously, shows could be set to play every hour or every half hour; they now can also be set to play every 15 minutes or every 10 minutes.
- Digital output (DO) pins 1 through 6 now operate. They react to commands for unit ID F0,

channels 1 through 6. They only react on the DC-MP3 that is controlling the show; for example, they will not react on a DC-MP3 controlled via the PC network.

- Under some circumstances, shows would start at midnight, without having been scheduled to do so. This has been fixed.

Bug Fixes

- Protection against several possible crashes was added to the [Light-O-Rama Control Panel](#). Although it is not known if any of these actually caused any crashes, it is known that some customers have had the Light-O-Rama Control Panel crash.
- When [disabling shows](#), or when [unloading Light-O-Rama](#), the [LOR Control Panel](#) would hang frozen for a noticeable amount of time before becoming responsive again (in the case of disabling shows) or closing (in the case of unloading).
- The [Light-O-Rama Control Panel's status window](#) would sometimes incorrectly state that the next show would start at 12:00 AM on Sunday.
- Sometimes, lighting commands were quickly repeated back-to-back. This would not cause any noticeable problems with how the sequence looked, but it did cause a minor increase in network traffic, or standalone/SD sequence file size.

What's New in Version 2.6.2

- [Light-O-Rama Diagnostic distributed by installer](#)
- [Bug fixes](#)

Light-O-Rama Diagnostic Distributed by Installer

The Light-O-Rama Diagnostic is a troubleshooting tool that displays various information about your Light-O-Rama configuration. It used to be available only as a separate download from lightorama.com, but now is installed as a standard part of the [Light-O-Rama Software Package](#).

Bug Fixes

- On Windows 98 SE machines, running a [show](#) of sufficient length would eventually cause an error message to pop up, saying that an error occurred in "Formhook_aftermessage". Clicking "OK" would close the error message, but it would soon pop up again, and again and again. If it was left without clicking "OK" to close it, eventually the show would stop abnormally.
- In the [Sequence Editor](#), "[Sequence Info](#)", from the "[View](#)" menu, would sometimes display the incorrect directory of the media file associated with a [musical sequence](#).
- If a [channel](#) was set up to be a [subsequence](#), and the [sequence](#) file assigned to it did not exist or otherwise could not be loaded, then loading of the main sequence would fail when the loading of the subsequence failed. The result of this was that the main sequence could not be opened, and so the problem could not be fixed by modifying the subsequence filename associated with the channel. Now, the main sequence will successfully load, and the missing subsequence will simply not do anything during play. Note that the [Light-O-Rama Verifier](#) will still show this error.
- If you set the name of a [channel](#) to include an ampersand, then in the [Sequence Editor](#), the name would be displayed on the [channel's button](#) improperly. The ampersand would be missing, and the character after it would be underlined (indicating that it could be used as a hotkey for that button).
- If the [Sequence Editor](#) was used on a computer with multiple monitors, and the cursor was hovered over a spot on a sequence grid that was on a monitor to the right of the primary monitor, the tool tip would pop up in the wrong place (on the far right side of the primary monitor).
- Hitting the escape key closes most dialogs, but it did not close the [Beat Wizard](#), [VU Wizard](#), or

[Tapper Wizard](#).

What's New in Version 2.6.0

- [Undo/redo recording can be disabled](#)
- [All license levels now use unencrypted save files](#)
- [Hardware Utility shows version of connected MP3 Director's firmware](#)
- [New DC-MP3 firmware: Version 3.3](#)
- [New Servo Dog firmware: Version 1.02](#)
- [Bug fixes](#)

Undo/Redo Recording Can Be Disabled

Certain very large operations in the [Sequence Editor](#) could take a very long time to do. For example, [skewing](#) a [track](#) involves changing all of the [timings](#), [effects](#), and [loops](#) in the track; in a large [sequence](#) with many [channels](#), this could take a prohibitively long time. Much of the time spent is actually due to recording the changes so as to later be able to [undo and redo](#) them.

For situations like this, [undo and redo recording can now be disabled](#), via the [Edit menu](#). You will not be able to undo any changes that were made while undo recording was disabled, but the changes that you make will be made more quickly.

All License Levels Now Use Unencrypted Save Files

In previous versions of Light-O-Rama, when a [sequence](#) was saved using either a [Basic license](#) or else the unlicensed Demo version of the software, the sequence file would be encrypted instead of being saved in plain XML. Now, this encryption is done only for the unlicensed Demo version; a Basic level license (or any other level license) will cause files to be saved unencrypted.

Hardware Utility Shows Version of Connected MP3 Director's Firmware

Previously, the [Hardware Utility's LOR MP3 tab](#) would show whether an MP3 Director was connected or not. Now, if one is, it additionally shows the MP3 Director's firmware version.

New DC-MP3 Firmware: Version 3.3

Version 3.2 of the DC-MP3 firmware (DC_MP3_V3-3.lhx) adds one new feature and fixes two bugs:

- Output number 8, which was previously unused, will now be high (+5 volts) when a show is active, and zero when no show is active.
- When a sequence started playing, in some rare cases the music and the lights would start off significantly out of sync with each other.
- A bug was causing trigger number 6 to interact with trigger number 3 in some cases.

New Servo Dog Firmware: Version 1.02

Version 1.02 of the Servo Dog firmware (ServoDog_V1-02.lhx) fixes a bug where if channels 1 and 8 were in digital output mode, there would be crosstalk causing random results.

Bug Fixes

- Certain ways of scrolling through the [channel](#) list in the [Animator](#) window were not working.

- [Skewing](#) a [track](#) would not work if the [timing grid](#) currently in use by the track was a [fixed timing grid](#).
- In the [Servo Dog Utility](#), when a channel button was clicked, if another channel button had previously been selected, there was a chance that the configuration of the channel that was clicked would be set to the same values as the configuration of the channel that had previously been selected.
- In the [Hardware Utility](#), controllers that were connected via Easy Light Linkers were not showing up in all cases.

What's New in Version 2.5.6

- [Bug fixes](#)

Bug Fixes

- If a [show](#) was [scheduled](#) starting on Saturday and ending on Sunday, instead of playing through, it would continuously shut down and restart. A common symptom of this is that the first [sequence](#) in the show's [musical section](#) would play over and over.

What's New in Version 2.5.4

- [Bug fixes](#)

Bug Fixes

- [X10 controllers](#) were not successfully being controlled in some situations.
- When a [sequence](#) was loaded, the zoom level of its [waveform display](#) was being set to a default value, rather than to the zoom level the sequence had been saved with.

What's New in Version 2.5.2

The following changes were made in this version:

- [LOR Control Panel's status window now displays a log](#)
- [Support for configuring Cosmic Color Ribbons](#)
- [Circuit IDs greater than 16 supported](#)
- [The Light-O-Rama ServoDog Utility](#)
- [Bug fixes](#)

LOR Control Panel's Status Window Now Displays a Log

The [Light-O-Rama Control Panel's status window](#) now displays a log of what is occurring with [shows](#). For example, it displays messages indicating that a show or a [sequence](#) is stopping or starting, that an error occurred playing a sequence, and that an [interactive trigger](#) was detected.

Support for Configuring Cosmic Color Ribbons

The [Hardware Utility's Configuration screen](#) now supports [configuring Cosmic Color Ribbons](#).

Circuit IDs Greater than 16 Supported

In previous versions, the [circuit IDs](#) of [Light-O-Rama controllers](#) could range from 1 to 16. They now can range from 1 to 256 instead.

Note that not all Light-O-Rama controllers have more than sixteen circuits, and of those that do, not all support this new feature yet (instead, they use more than one [unit ID](#), each with sixteen possible circuit IDs). Currently, the only Light-O-Rama controller that can be set to use more than sixteen circuit IDs for a single unit ID is the Cosmic Color Ribbon. Support for this feature in some other controllers is planned for the future, at which time firmware upgrades may be necessary to take advantage of it.

The Light-O-Rama ServoDog Utility

The [Light-O-Rama ServoDog Utility](#) is a new program which can be used to configure Light-O-Rama ServoDog controllers.

Bug Fixes

- If an error opening a comm port occurred when the [Hardware Utility](#) was being started, this could lead to strange errors later, such as the Hardware Utility unexpectedly closing in certain situations.
- If the [musical section](#) of a [show](#) contained [sequences](#) that could not be played due to errors, then in some situations the first sequence of the musical section of the show might repeat several times in a row.
- On some computers, when a Light-O-Rama program (such as the [Sequence Editor](#)) was started, it would open in [Demo mode](#) very frequently, despite having previously been [activated](#) (and without having upgraded to a new version).
- In the [Sequence Editor](#), if you clicked the space bar to start play while the mouse button was down, then when play ended, you would be in "mouse dragging" mode, no matter whether you subsequently released the mouse button or not.
- If you used a countdown in the [Tapper Wizard](#), sometimes the song would not start after the conclusion of the countdown.
- Various problems would occur if you set the default Sequences and Audio directories to be top level directories of a drive (for example, "C:\Sequences" and "C:\Audio" rather than "C:\LOR\Sequences" and "C:\LOR\Audio").
- In some situations, deleting a [track](#) from a [sequence](#) would cause the [track dropdown list](#) and the [timing grid dropdown list](#) to misbehave.

What's New in Version 2.4.10

The following changes were made in this version:

- [Exporting/importing channel configuration with tracks improved](#)
- [Commands sent to Holiday Lights Designer regardless of licensing level](#)
- [Hardware Utility supports DIO32 servo configuration](#)
- [Refresh command made quicker](#)
- [Bug fixes](#)

Exporting/Importing Channel Configuration with Tracks Improved

In previous versions of Light-O-Rama, [exporting and importing channel configuration](#) from and to [sequences](#) that have more than one [track](#) could lead to strange, and probably undesired, results. This was due to the interaction between [channels](#) that were in more than one track of the sequence

and channels that were in more than one track of the configuration file. If the positions of such channels did not match up between the sequence and the configuration file, then the resulting settings of those channels would be changed in a predictable, but probably undesired, way.

In this version, the method of importing has been altered, so as to give (hopefully) better results:

Unlike in previous versions, the first step to importing channel configuration, before any channels are actually imported from the configuration file, is now to check the sequence for channels that are in more than one track. If any such channels are found, then all copies of each channel, except for the first of each channel, are removed from the sequence.

Next, channels are imported from the configuration file. But unlike in previous versions, if a channel is in more than one track of the configuration file, instead of overwriting the settings of an existing channel in the sequence every time the channel is encountered in the configuration file, that is only done on the first encounter of the channel. Instead, on subsequent encounters of the same channel, a copy of the appropriate channel from the sequence is inserted into the track at the appropriate position.

This has two potential side effects to watch out for (although both of these seem minor compared to the side effects caused in previous versions):

First, if a track in the sequence is composed entirely of channels from previous tracks, and the channel configuration file has no track in the same position, then all channels will be removed from that track. Since the track has no channels, it will then be removed from the sequence. However, note that these channels have not been removed from the sequence - they have only been removed from the track. They are still in the earlier tracks.

Second, a channel from the sequence with no corresponding channel in the configuration file could get "pushed down" towards the bottom of the sequence's track, if the channel configuration file contains channels in that track which are copies of channels from earlier tracks.

Commands Sent to Holiday Lights Designer Regardless of Licensing Level

Different [licensing levels](#) can control different numbers of [controllers](#); for example, the Basic level can control two controllers, while the Advanced level can control an unlimited number of controllers. If a [sequence](#) contains a [lighting effect](#) for a controller that the license level cannot control, the effect is simply not sent to the controller.

In previous versions, this also applied to sending commands to [Holiday Lights Designer](#): lighting effects could be sent to Holiday Lights Designer only if they could be sent to an actual controller, based on the license level. Now, lighting effects can always be sent to Holiday Lights Designer, regardless of the licensing level.

Hardware Utility Supports DIO32 Servo Configuration

The [Hardware Utility](#) can now be used to [configure the DIO32 for servos](#).

Refresh Command Made Quicker

The [Hardware Utility's Refresh](#) command, used to scan a [Light-O-Rama network](#) for [controllers](#), now works more quickly than it did before.

Bug Fixes

- If a [show](#) contains some [sequences](#) in a "[Magic Toy](#)" [interactive group](#), and a trigger in that group is triggered, any playing sequences that happen to be from that same interactive group should be, but were not, stopped, before the newly triggered sequences start.
- The [Channel Property Grid](#) would allow you to remove the last [channel](#) from a [track](#), which would lead to undesired behavior. It now no longer allows the last channel to be removed from a track.
- There must be a [channel](#) in every [track](#); Light-O-Rama should prevent you from removing the last channel from a track. Due to bugs, though, it's possible that the last channel could be removed from a track; in such a case, if the [sequence](#) were saved, it could not thereafter be reloaded. In this version, the sequence can now be loaded, but any tracks without channels will automatically be removed from the sequence during the load.
- [Input triggers](#) would work correctly only for the first eight [circuits](#) of a [controller](#). They now work on the full sixteen.

What's New in Version 2.4.8

The following changes were made in this version:

- [Tapper Wizard improvements](#)
- [Animator's twinkle effect made more realistic](#)
- [Fade Tool Settings and Intensity Tool Settings can be toggled on and off](#)
- [New keyboard shortcuts for selecting the current tool](#)
- [Keyboard editing while using the Animator made easier](#)
- [File saving made safer](#)
- [Track bar of active track highlighted](#)
- [Bug fixes](#)

Tapper Wizard Improvements

The [Tapper Wizard](#) was improved in several ways:

- It now knows about [timing grids](#). You can select an existing grid to use, or create new grids to use, from within the Tapper Wizard itself.
- Inserting [timings](#) and inserting [lighting effects](#) can now be done independently of each other - you can do either or both.
- You can play a particular part of a song, rather than the whole song. When the Tapper Wizard is first opened, its play range will automatically be set to the active [track's freeform play range](#), if there is one, or to its normal [play range](#) (such as [play full sequence](#) or [play visible screen](#)) if not.
- You can set the play speed, either to normal speed, half speed, or double speed.
- It can be used repeatedly without closing, with or without tapping again. For example, after applying your taps to the sequence, you could collect a whole new set of taps, or you could apply your existing taps to the sequence again, in a new way (such as applying them to a different channel, or with different flash and fade times), all without ever closing the Tapper Wizard.
- It supports undo and redo within itself; you do not have to close the Tapper Wizard to undo or redo its changes.
- It no longer relies on helper forms to collect information (such as the length of time that a flash should take); this information is now set via fields on the Tapper Wizard itself.
- The settings that you choose, such as whether to use a countdown, how long that countdown should be, whether to use the mouse, the keyboard, or both, what kind of effects or timings should be inserted, and so forth, are remembered, so that you do not have to change them every time that you enter the Tapper Wizard.

Animator's Twinkle Effect Made More Realistic

Recent efficiency improvements to the [Animator](#) increased the speed it could redraw at. This had the side effect of making its [twinkle](#) effects twinkle too quickly, almost looking like [shimmers](#). The Animator's twinkle effect has now been slowed back down, to more closely resemble the twinkle effect on [actual lights](#).

Please note that this change does not affect the way that twinkle behaves on your lights at all; they will behave exactly as they always have. It only affects how twinkle is represented in the Animator (which is an approximation, not an exact representation, of how it looks on actual lights).

Fade Tool Settings and Intensity Tool Settings Can Be Toggled On and Off

In previous versions, clicking of the [Fade Tool Settings toolbar button](#) would open the [Fade Tool Settings dialog](#), as would clicking on the [Tools menu's](#) Fade Tool Settings item. The only way to close the dialog was to click on its Windows close button, or to use the escape key. Now, the toolbar button (or the menu item) can be used as a toggle - clicking it once shows the dialog; clicking it again hides it.

A similar change was made for the [Intensity Tool Settings dialog](#).

New Keyboard Shortcuts for Selecting the Current Tool

When editing [sequences](#) via the [keyboard](#), previous versions would allow you to hit the Enter key to apply the current tool to the selected area of the sequence. Alternatively, to apply a different tool, you could hit some other key, specific to that tool; this would leave the current tool the same as it was. For example, if the current tool was the [shimmer](#) tool, you could hit Enter to apply a shimmer, or "T" to apply a [twinkle](#).

However, the current tool itself could not be selected except via the [toolbar](#), or menu items on the [Tools menu](#). It can now be selected via the keyboard as well, by using Shift in addition to the desired effect's normal key. For example, Shift-T will change the current tool to change the current tool to be the twinkle tool. Note that this leaves the sequence itself untouched (but you can still hit Enter to apply the current tool to the sequence, or one of the specific keys to apply some other tool).

Due to this change, certain existing keyboard shortcuts had to be remapped. Specifically, Shift-S, Shift-T, Shift-I, Shift-U and Shift-D used to change the current [custom tool](#) to be a custom shimmer, twinkle, intensity, fade up, or fade down, respectively. These have been replaced with Ctrl-Shift-S, Ctrl-Shift-T, Ctrl-Shift-I, Ctrl-Shift-U, and Ctrl-Shift-D, respectively.

Keyboard Editing while Using the Animator Made Easier

When you click on a control in the [Animator](#), after that control's operation has completed, the focus is now immediately given back to the sequence grid. The effect of this is that you can continue using the [keyboard](#) to edit the sequence without needing to mouse-click on it every time you change something in the Animator.

File Saving Made Safer

Previously, when the [Sequence Editor](#) saved a [sequence](#), it would delete the backup file of that

sequence, then rename the existing save file to the backup, then write a new version of the save file, then verify that it could load the new version of the save file. If it could not load the new version, it would give a warning message saying so, and giving the name of the backup file.

Instead, it now writes the sequence to a temporary file, then verifies that it can load that temporary file. Only if it can load the temporary file does it then proceed to delete the backup file, rename the existing save file to the backup, and finally rename the temporary file to the real save file name.

Track Bar of Active Track Highlighted

In the [Sequence Editor](#), the [track bar](#) of the currently active [track](#) in a [sequence](#) is now colored green, so as to make it easily distinguishable from the other tracks.

Bug Fixes

- In the [Sequence Editor](#), if the total time of a [track](#) was increased, and that track was currently using a [fixed timing grid](#), an error message would pop up saying that timings cannot be added to fixed grids.
- If the Windows option "Hide extensions for known file types" was turned on, the [New and Open dialog's "Existing Sequence" tab](#) would not properly display the type of each file.

What's New in Version 2.3.8

This version fixes the following bugs:

- In the [Sequence Editor](#), when the [mouse](#) was moved to the left of the channel bar, an error message would sometimes pop up, saying "Invalid centisecond for finding timing", followed by a negative number. This would always happen when the mouse was dragging, and sometimes happen otherwise.
- On some computers running Windows Vista, installation would fail, giving an error about Microsoft's MDAC component.

What's New in Version 2.3.6

This version fixes the following bug: Upon upgrade from a previous version of Light-O-Rama, if the user chose a different directory to store sequence and audio files than was chosen for the previous version, the post-install process would neglect to copy the files from the old directory to the new one.

What's New in Version 2.3.4

The following changes were made for Light-O-Rama version 2.3.4:

- [Timing grids](#)
- [The Light-O-Rama Verifier](#)
- [Beat Wizard and VU Wizard improvements](#)
- [Initial play of sequences sped up](#)
- [Events straddling the start of a play range are played](#)
- [New and Open dialog improvements](#)
- [New musical sequence's initial channels can be based on a channel configuration file](#)
- [New musical sequence's artist, album, and song names pulled from MP3](#)
- [Support for normally closed input triggers](#)

- [Interactive triggers can be tested in the Hardware Utility](#)
- [Maximum and minimum intensities read from controller](#)
- [Extra Information in sequence grid tooltips](#)
- [Control Panel's status window can be minimized](#)
- [Fades are smoother in the Animator](#)
- [Animator CPU utilization improved](#)
- [Animator redraw throttling configurable](#)
- [Zooming with the Animator's autosize mode](#)
- [Bug fixes](#)

Timing Grids

A [timing grid](#) is a collection of [timings](#). A [sequence](#) can have more than one timing grid, but only one (per [track](#)) is displayed at any given time. You can quickly change which timing grid is displayed at any time by selecting from the [Tracks and Timings toolbar's timings dropdown list](#).

There are two types of timing grids: [fixed timing grids](#), which have timings at equal distances from each other, and which cannot have timings added, removed, or moved, and [freeform timing grids](#), which can have timings anywhere, and which can have timings added, removed, or moved.

Timing grids are intended to better fulfill a role that was fulfilled in previous versions of Light-O-Rama by tracks: Allowing different sets of timings to be used on the exact same channels.

For example, perhaps you have a song for which you would like some lighting effects sequenced to the sound of the bass drum, and other lighting effects sequenced to the sound of the lead guitar. You could simply add timings for both, but this could make it easy to forget which timing is for which instrument; it could also make the display seem too cluttered with timings.

To solve this problem in previous versions of Light-O-Rama, you could duplicate the track to a new track, so that you had two different tracks in the sequence, both with the same channels as each other. The two tracks could use different timings, one track representing the bass drum and the other representing the lead guitar.

You can still do that in this new version of Light-O-Rama, but you can now instead solve the problem by using timing grids. Instead of adding a second track, you could add a second timing grid. One timing grid would represent the bass drum, and the other would represent the lead guitar. You could quickly switch which timing grid is displayed using the Tracks and Timings toolbar's timings dropdown list, changing back and forth between drum and guitar as appropriate, all with only a single track.

The Tracks and Timings toolbar also has a [timings button](#); clicking on it will open a popup menu with various timings grid-related options, such as adding a new timing grid or deleting an existing one.

When this new version of Light-O-Rama opens a sequence created with a previous version (in which there was no such thing as a timing grid), it will automatically create one freeform timing grid per track in the sequence.

The Light-O-Rama Verifier

The new [Light-O-Rama Verifier](#) program can be used to check for certain types of problems with your Light-O-Rama configuration, [schedule](#), [shows](#), and [sequences](#). By using the Verifier, you may be able to fix these problems before they cause any issues when your show is played.

Beat Wizard and VU Wizard Improvements

In previous versions, the [Beat Wizard](#) and the [VU Wizard](#) would always add [timings](#), regardless of whether they were also adding [effects](#) or not. They can now add timings and effects independently of each other.

Also, when inserting effects, they can now optionally snap them to the timings being used.

Initial Play of Sequences Sped Up

The amount of time that it takes for a [sequence](#) to start playing the first time after it is loaded (or after it is changed or the [play range](#) is changed) has been decreased.

Events Straddling the Start of a Play Range Are Played

In the [Sequence Editor](#), if the [play range](#) is set to anything other than the full [sequence](#), and an [effect event](#) starts before the play range starts but ends during (or after) the play range, previous versions of Light-O-Rama would not control the lights based upon that event. Instead, now, the portion of the event within the play range is sent to the lights (for example, if the event is a [fade up](#) from 0% to 100% from 36 seconds to 38 seconds, and the play range starts at 37 seconds, the lights will be sent a command to fade up from 50% to 100%).

New and Open Dialog Improvements

Several improvements were made to the [Sequence Editor's New and Open dialog](#):

In previous versions, the dialog was a fixed size, which could not be changed. It can now be resized or maximized, and will remember its sizing and positioning even after the Sequence Editor is closed and restarted.

The dialog's [Existing Sequence tab](#) used to always show a list of folders and sequences in a single way. It now has an option to change the view, similarly to Windows Explorer. For example, if the "Details" view is selected, then in addition to file names, details such as file sizes and modification dates will be displayed. Clicking on a column header in the "Details" view will sort the files by that column; clicking on it again will sort in reverse order. The dialog will remember the selected view and sorting behavior even after the Sequence Editor is closed and restarted.

The Existing Sequence tab now also has a "Search" box. If you type something into this box, only files with that somewhere in their name will be listed. Wildcard characters (*, ? and #) are supported in the search box.

The [Standard Toolbar's "Open" button](#) would previously always open the dialog to the "Existing Sequence" tab. It now instead opens it to whichever of "Existing Sequence" or "[Recent Sequence](#)" was most recently used.

New Musical Sequence's Initial Channels Can Be Based on a Channel Configuration File

When you create a new [musical sequence](#), the [New Musical Sequence dialog](#) now lets you base the initial [channels](#) for the [sequence](#) off of the contents of a [channel configuration file](#), rather than simply specifying a number of channels.

New Musical Sequence's Artist, Album, and Song Names Pulled from MP3

If you create a [musical sequence](#) based on an MP3 file, the [New Musical Sequence dialog](#) automatically uses the artist, album and song names from the MP3 itself (if the MP3 is tagged with this information). You can still change these in the dialog if you wish.

Support for Normally Closed Input Triggers

Previous versions of Light-O-Rama only supported normally open circuits for use as [input triggers](#). Normally closed circuits are now supported as well, via the [Hardware Utility's LOR controller configuration screen](#).

You may need to [update the firmware](#) of your controller in order to take advantage of this new feature.

Interactive Triggers Can Be Tested in the Hardware Utility

The [Hardware Utility's LOR controller testing screen](#) can now be used to [test input triggers](#) from [LOR controllers](#).

Maximum and Minimum Intensities Read from Controller

The [Hardware Utility's LOR controller configuration screen](#) can now read the [maximum and minimum intensity settings](#) of a [Light-O-Rama controller](#) from the controller itself.

You may need to [update the firmware](#) of your controller in order to take advantage of this new feature.

Extra Information in Sequence Grid Tooltips

The tooltip displayed in the [Sequence Editor](#) when the [mouse](#) hovers over a cell in a [sequence](#) now includes more information than before, including details on the [effect event](#) being hovered over.

You can configure various settings about the tooltips, such as how long they take to open and how they close, via the [Display Preferences](#) dialog.

Control Panel's Status Window Can Be Minimized

The [status window](#) of the [Light-O-Rama Control Panel](#) can now be minimized to the Windows task bar.

Fades Are Smoother in the Animator

The [Animator](#) used to display [fades](#) in a somewhat jerky manner, only updating the display after the color of a cell has changed by a fairly significant amount. Depending upon the speed of the fade, this would lead to fades more as steps through several intensities rather than as actual fades (note that this only affected the appearance of the Animator, not the appearance of any real lights that you had hooked up via [controllers](#)). Fades should now appear more smoothly in the Animator.

Animator CPU Utilization Improved

Various changes were made to the [Animator](#) to decrease the amount of CPU time that it takes to

display the animation.

Animator Redraw Throttling Configurable

During play, the [Animator](#) only redraws the [animation](#) every so often, rather than every time that something changes. This is to try to ensure that it does not use too much CPU time. In the past, the amount of time between redraws was a certain constant value; now, you can [modify it](#) in the [Display Preferences dialog](#), to try to strike an appropriate balance between CPU usage and smoothness of display for your individual computer.

Zooming with the Animator's Autosize Mode

When the [Animator's](#) controls are [hidden](#), expanding and contracting the Animator's window is supposed to also automatically resize the drawing area within the window. However, due to certain sizing requirements, the drawing area can only be certain possible sizes for any given [animation](#). So, when the window was manually resized by clicking and dragging a side or a corner, the drawing area would remain the same size, until the window got large enough to hold the next possible size, at which time the drawing area would "jump" to the new size.

To make this autosizing quicker and easier, the ability to manually resize by dragging a side or a corner of the window has been replaced by "zoom" buttons on the toolbar, which will immediately resize the window (and the drawing area) to the next possible size.

Bug Fixes

This release fixes the following issues:

- If the same [show](#) had been [scheduled](#) twice back-to-back, it would have simply continued playing rather than stopping and restarting.
- If a [channel](#) was set up to represent a [subsequence](#), changing the subsequence file associated with the channel would not cause the channel's main [sequence](#) to be marked as having unsaved changes.
- If a [musical sequence](#) based on a MIDI file was playing in the [Sequence Editor](#), and was paused or stopped before its natural end, and the sequence had used the [MIDI Wizard](#), then the Sequence Editor would not send out MIDI commands saying to stop sounds. This caused whatever notes happened to be playing when the sequence was paused or stopped to continue playing indefinitely.
- If the [VU Wizard](#) were used to toggle cells on and off during part of a song, as opposed to the entire song, it would sometimes get the toggling backwards, turning on cells that should have been turned off, and vice versa.
- If the [VU Wizard](#) were used to toggle cells on and off during part of a song, as opposed to the entire song, it would not necessarily get the state of the first or the last cell in the range correct.
- If the [VU Wizard](#) were set up such that the entire selected area of the song was below the specified peak threshold, an error box would appear, saying "Subscript out of range".
- If an [animation](#) had a [background image](#), and the [Animator's](#) controls were [hidden](#), resizing the window would not necessarily keep the image's proportions as they were.
- If the [Animator's](#) controls were [hidden](#), resizing the window would only automatically resize the [animation](#) if it had a [background image](#).
- The menu items on the [Wave Form submenu](#) of the [Sequence Editor's View menu](#) would not become checked until one of them (or the [View Waveform](#) button on the [Standard Toolbar](#)) was clicked.
- When the [Sequence Editor's New and Open dialog](#) is first opened, its dropdown list of folders did not include all of the immediate child folders of "My Computer".

- In the [Hardware Utility's Test Console](#), clicking the "All Off" or "All On" buttons would move the intensity sliders appropriately, but would not update the text boxes beneath them to say the new intensities.
- If Windows suspended while the [Sequence Editor](#) was open, and a USB adapter was in use for an [LOR comm port](#), then when Windows resumed, the Sequence Editor would be locked up.
- The [Hardware Utility](#) would shut down without warning if "Lights Off" or "All Off" were pressed while the [LOR comm port](#) was set to a port number that could not be initialized.
- The [Hardware Utility](#) would shut down without warning upon trying to initialize an [X10 CM-11A](#) device on a port that had (till that point) been assigned to [LOR devices](#).

What's New in Version 2.1.6

This version fixes the following bugs:

- If the [waveform display](#) were used with a completely silent audio file, the [Sequence Editor](#) would crash.
- If a [sequence](#) had a [Windows shell command](#), and it were saved to a different filename than it had been loaded with, future changes to the Windows shell command in one of the two sequences would affect the Windows shell command in the other sequence as well.
- [Shows scheduled](#) by the [Simple Show Builder](#), and run via the PC, would not necessarily end at their appropriate time.

What's New in Version 2.1.4

This version fixes the following bugs:

- In certain situations, adding a [sequence](#) to an [MP3 Player Showlist](#) would fail, with an error message saying "Path/File Access error".
- [Sequences](#) downloaded to an [MP3 director](#) would have their final [lighting effect](#) cut off prematurely.
- The [Sequence Editor's New Musical Sequence Preferences](#) dialog would not allow you to change the default timings to certain values ("MIDI Wizard", "Beat Wizard", and "VU Wizard") if you opened the dialog via the "New Musical Sequence Preferences" menu item on the [Preferences submenu](#) of the [Edit menu](#).

What's New in Version 2.1.2

The following changes were made for Light-O-Rama version 2.1.2:

- [Licensing](#)
- [Custom fade/intensity twinkles and shimmers](#)
- [Triggered interactive sequences](#)
- [Show startup options](#)
- [Windows shell commands](#)
- [DMX intensity](#)
- [The New and Open dialog](#)
- [Keep lights on at end of play](#)
- [Automatic channel settings for newly created sequences](#)
- [Events can be dragged with timings](#)
- [Change in behavior for mouse switching tracks](#)
- [Animation sequences in the musical section cut off at end of show](#)
- ["Max Units" in Hardware Utility changed to "Max Unit ID"](#)
- [Bug fixes](#)

Licensing

The [Light-O-Rama Software Package](#) must now be registered with a valid license in order to unlock its full potential. There are several different license levels, each with different features available. Additionally, Light-O-Rama can be run without a license, as a Demo version; the Demo version cannot be used to actually control lights, though.

Existing customers who have purchased earlier versions of the Light-O-Rama software package are entitled to a free license of the highest level ("Advanced").

For details about registering and about the features available with the different licenses, please see [Registering Light-O-Rama](#) and [Feature Comparison](#).

Custom Fade/Intensity Twinkles and Shimmers

In previous versions of Light-O-Rama, [twinkling](#) or [shimmering](#) the lights could only be done at full intensity. You can now use new [custom tools](#) to twinkle or shimmer the lights while fading them up or down, or at some intensity other than full intensity.

Existing [Light-O-Rama controllers](#) may need [firmware upgrades](#) to take advantage of this new feature; if a custom twinkle or shimmer is sent to a controller without the upgrade, it will react as if it were a "regular" twinkle or shimmer - i.e. it will twinkle or shimmer at full intensity.

Triggered Interactive Sequences

In addition to being able to [control lights](#), some [Light-O-Rama controllers](#) can now act as input triggers. This allows [sequences](#) to be played on demand during a [show](#) - for example, your display may have a group of buttons that people can press, each of which will cause a different song to be played.

For details, please see the help file page "[Interactive Groups](#)".

Show Startup Options

In previous versions of Light-O-Rama, the [sequences](#) in a [show](#) would start playing immediately at the show's [scheduled](#) start time. There is now more flexibility with regards to this; for example, you could hook a big red button labeled "Start the Show" up to one of your [Light-O-Rama controllers](#), and the show will not be started until that button is pushed.

For details, please see "[Show Startup Options](#)".

Windows Shell Commands

Your [sequences](#) can now be configured so that, whenever one is played, Light-O-Rama will execute any arbitrary Windows command that you associate with that sequence.

An example of how this might be useful: If you broadcast the songs playing during your [show](#) over the radio, and have hardware allowing you to broadcast RDS ("Radio Data System") information, you can now set your sequences up so that, whenever one is played, Light-O-Rama will tell Windows to tell your RDS program to broadcast the name of the song for that sequence.

For details, please see the help file page "[Windows Shell Commands](#)".

DMX Intensity

A new effect, "[DMX Intensity](#)", has been added. This can be used to specify 256 possible intensities (from 0 to 255), rather than the regular 101 possible intensities (from 0 to 100). This is useful for DMX devices, which can take up to 256 possible intensities.

Note: The DMX intensity tool is not available by default in the [Sequence Editor](#) - for example, by default, no toolbar button will be displayed for it. To enable the tool, select "Allow DMX Editing" from the [DMX Preferences menu](#).

The New and Open Dialog

The [Sequence Editor's](#) new "[New and Open dialog](#)" allows you to create a new [sequence](#), or open an existing one. This dialog is opened by default when the Sequence Editor starts up (although this behavior can be suppressed), and also when something like "New" or "Open" is selected from the [File menu](#) or the [Standard toolbar](#).

Keep Lights On at End of Play

For most sections in a [show](#), you can now use the [Show Editor](#) to specify whether or not [sequences](#) in that section will automatically turn their lights off when they end playing.

There are two exceptions: First, the [Background section](#) does not allow this setting. Second, the [Interactive section](#) allows you to control this for each [interactive group](#) individually, rather than for the section as a whole.

Automatic Channel Settings for Newly Created Sequences

When creating a new [musical sequence](#) or new [animation sequence](#), you now have the option to automatically configure the [channels](#) in the new [sequence](#) to use standard [Light-O-Rama controllers](#). The first channel will be set up to use Light-O-Rama [unit 1 circuit 1](#), the next unit 1 circuit 2, and so forth, then on to unit 2, and so forth. All such channels will be configured to use the regular [LOR network](#).

Events Can Be Dragged with Timings

When a [timing](#) is dragged in the [Sequence Editor](#), to change the time it is at, there is now an option to also drag any [effect events](#) that start or end at that timing along with it.

This option is controlled via the [Edit menu's](#) "[Drag Events with Timings](#)" checkbox.

Change in Behavior for Mouse Switching Tracks

Switching to another [track](#) via the [mouse](#) in the [Sequence Editor](#) now causes the selected area for that track to be set to the cell that was clicked, even if that cell is within what used to be the selected area for that track. In particular, if a [tool](#) other than "[Select](#)" is enabled, that tool will be applied to the new selection, not the old one.

Animation Sequences in Musical Section Cut Off at End of Show

In previous versions, when a [show](#) reached its [scheduled](#) end, if a [sequence](#) from the [musical section](#) of the show happened to be playing, that sequence would continue playing to its natural end before the [shutdown section](#) of the show would begin. Now, that is only the case for [musical sequences](#); if the sequence is an [animation sequence](#), it will abruptly stop at the scheduled end of show, regardless of the fact that it is in the musical section of the show.

"Max Units" in Hardware Utility Changed to "Max Unit ID"

When the [Hardware Utility](#) is asked to automatically detect [units](#), it must individually search for each possible [unit ID](#). This may take some time to do. To speed this up, the Hardware Utility allowed you to specify a maximum number of units to search for, in a box labelled "Max Units". For example, if you set "Max Units" to "3", the Hardware Utility would search for a controller with unit ID 01, another with unit ID 02, and a third with unit ID 03. It would not check for any unit IDs past 03. However, this often led to the following confusion:

Unit IDs are given in hexadecimal notation. So, for example, the next unit ID after 09 is not 10, but 0A. That is followed by 0B, 0C, 0D, 0E, and 0F, and only then does 10 come. So, if a person's highest unit ID was 10, they might be misled to thinking that they should input "10" into "Max Units". But "Max Units" was merely a count, not an ID, meaning that the Hardware Utility would only search for the first ten possible unit IDs, i.e. 01 through 09 and 0A. Therefore, unit 10 would not be found (as it is actually the sixteenth possible unit ID).

To get rid of this common source of confusion, "Max Units" was changed to "Max Unit ID". So now, for example, entering "10" will search for unit IDs 01 through 09, unit IDs 0A through 0F, and unit ID 10.

Bug Fixes

This release fixes the following issues:

- If the [Play Again button](#) on the [Standard Toolbar](#) of the [Sequence Editor](#) were hit quickly two times in succession, an error message box would appear.
- If the "[turn a channel on and off](#)" feature of the [VU Wizard](#) were used on only part of a [musical sequence](#), it would correctly turn the [channel](#) on and off in that part, but would additionally turn everything in the channel *past* that part off.
- In certain situations, when scrolling through [tracks](#) in the [Sequence Editor](#), the [track bar](#) for some tracks would not be displayed, and instead part of the previously displayed channel grid would be displayed where the track bar should have been.
- If certain Light-O-Rama entries in the Windows registry were mistakenly deleted (for example, by a third-party registry cleaning program), and a [musical sequence](#) were modified and saved, the name of the sequence's media file would not be saved along with it, and you would be unable to modify the sequence again to tell it the name of the media file. This effectively means that the musical sequence would be "transformed" into an [animation sequence](#). This no longer occurs. Note, though, that Light-O-Rama still might not be able to play the sequence, as those registry entries tell it where to look for media files. But after the issue with registry is corrected, Light-O-Rama will now play those musical sequences as normal.
- If a [sequence](#) had a [channel](#) that was set up to be a [Light-O-Rama controller](#), but did not have its [unit ID](#) set, that sequence would not play in the [Show Player](#).
- Removing a [channel](#) that was in more than one [track](#) from a track would not cause the [sequence](#) to be marked as having unsaved changes.
- If [paste by cell](#) is enabled, and [effect events](#) copied from a larger cell are pasted to a smaller cell, those events are "shrunk" to fit into the smaller cell. If such an event had to be shrunk to less than a centisecond in length, pasting would fail, giving an error message "Start time cannot be

less than end time". Now, events shrunk to less than a centisecond are simply skipped when pasting.

- When creating an SD card for an [MP3 Director](#), a valid COM port is no longer required.
- Some machines were having problems [downloading standalone sequences](#) to [controllers](#). The reliability of downloading has now been improved.
- When [setting a unit ID](#) via the [Hardware Utility](#), the dropdown boxes allowing you to select a [unit ID](#) only show unit IDs from 01 up to the unit ID specified in the Hardware Utility's "Max Unit ID" setting. Previously, though, changing "Max Unit ID" would not change the values listed in the dropdown boxes, until the Hardware Utility was closed and then restarted. Now, the new values will be available immediately, without needing to close and restart.

What's New in Version 2.0.16

The following changes were made for Light-O-Rama version 2.0.16:

- [Simple Show Builder updated](#)
- [Bug fixes](#)

Simple Show Builder Updated

Previous releases of Light-O-Rama version 2 included the same [Simple Show Builder](#) as was used in Light-O-Rama version 1. It therefore could not be used with [sequences](#) that were created using the version 2 [Sequence Editor](#).

Simple Show Builder has now been updated so that it can be used with sequences that were created using either version 1 or version 2.

Bug Fixes

This release fixes the following issues:

- Various tools such as the [Beat Wizard](#), [VU Wizard](#), and [Waveform Display](#) had problems with certain audio files, resulting in an error message saying "Can't init conversion" appearing, after which these tools would be unusable with those files. This release fixes this issue (at least in the known situations that it happened in).
- The [Beat Wizard](#) would crash when used with certain audio files on some customers' machines.
- If either "[Close All Files](#)" or "[Close All Files Except This](#)" was used, and one of the [sequences](#) being closed had its [Animator](#) window open, an error message would pop up saying "Error Loading Animation Form".

What's New in Version 2.0.14

The following changes were made for Light-O-Rama version 2.0.14:

- [New play ranges](#)
- [Freeform play mode](#)
- [Space Bar to play; enter to apply tool](#)
- [Subdividing cells](#)
- [Skewing tracks](#)
- [Waveform height](#)
- [Waveform display modes](#)
- [Waveform colors](#)

- [Bug fixes](#)

New Play Ranges

Two new [play ranges](#) have been added to the [Sequence Editor](#): "[From Selection](#)" plays from the start of the selection to the end of the sequence, and "[To Selection](#)" plays from the start of the sequence to the end of the selection.

Freeform Play Mode

You can now use the keyboard to select an arbitrary time range for future playing. Please see "[Freeform Play Mode](#)" for details.

Space Bar To Play; Enter To Apply Tool

In the [Sequence Editor](#), the space bar can now be used to start a [sequence](#) playing, and then to stop it. If a [freeform play range](#) has been selected, that range will be played; otherwise, play will be in "[from selection](#)" mode - that is, it will start at the start of the current selection, and go until the end of the sequence. This can be used to effectively pause and unpause play.

In previous versions of Light-O-Rama, the space bar was used to apply the current [effect tool](#) to the selected cells. That is now done using the enter key instead.

Subdividing Cells

The [Sequence Editor](#) can now subdivide the selected cell or cells into a new number of cells (which you select). Each cell is subdivided into the specified number of cells, and all of the new cells within any particular old cell will be of the same length (or as close to the same length as possible).

For example, if you select two cells, the first from 3 seconds to 7 seconds, and the second from 7 seconds to 7.5 seconds, and ask the Sequence Editor to subdivide them into two cells each, you will wind up with four cells: From 3 to 5, from 5 to 7, from 7 to 7.25, and from 7.25 to 7.5.

This can be done via "[Subdivide Timings](#)" on the [Timings submenu](#) of the [Edit menu](#), or via "[Subdivide Timings](#)" on the [right-click context menu](#).

Skewing Tracks

The [Edit menu](#) of the [Sequence Editor](#) now has a new menu item, "[Skew Track](#)". This lets you move all of a [track's events](#), [timings](#), and [loops](#) by a specified amount of time, either to the left (i.e. earlier in time) or to the right (i.e. later in time).

Waveform Height

In previous versions of Light-O-Rama, the [waveform](#) of a [musical sequence](#) was either displayed or not. Now, if it is displayed, it can be displayed at two different heights: full height and half height. Full height is the same as the height that was used in previous versions of Light-O-Rama.

Half height and full height (and "off") can be selected from the [Wave Form submenu](#) of the [View menu](#).

Waveform Display Modes

The [waveform](#) of a [musical sequence](#) can now be [displayed in three different ways](#): "full mode", showing zero volume at the center and loud volumes above and below it; "fold mode", showing zero at the bottom and folding the two halves of full mode onto the top; "top mode", showing zero at the bottom and the top half of full mode above it. "Full mode" is the same as the way the waveform was always displayed in previous versions of Light-O-Rama.

To set the display mode, right-click on the waveform, and select the desired mode from the listed choices in the popup menu.

Waveform Colors

The colors used to display the [waveform](#) of a [musical sequence](#) are now configurable. To choose new colors, right-click on the waveform, and select "[Change Colors](#)" from the popup menu.

Bug Fixes

This release fixes the following issues:

- In the [Channel Property Grid](#), if a channel was set up with a device type but no unit number and/or circuit number, it might later be displayed (in both the Channel Property Grid and the [Channel Settings dialog](#)) as if it had a unit number and/or circuit number set (although it still did not).
- When printing from the Channel Property Grid, unit numbers of some [Light-O-Rama controllers](#) would be mislabelled, as would device types of certain [non-Light-O-Rama controllers](#).
- If a [sequence](#) was changed, but not yet saved, and "[Revert to Saved](#)" was selected from the [File menu](#), the sequence would be properly reloaded, but could not be played again until it was closed and reopened.
- Several dialog windows had a problem where, if the dialog was closed by hitting the enter key rather than by clicking the OK button, changes to the last field modified might not be acted upon.
- If a [channel](#) was in two or more [tracks](#), and had a [shimmer](#) effect, the effect would not be displayed properly in the [Animator](#).
- If a [sequence](#) was playing in the [Sequence Editor](#), and some other sequence was not playing but had its [Animator](#) open, clicking on that Animator's play button would set off a string of errors. Now, instead, it simply does not start play (while the other sequence is playing).
- A problem with undoing and redoing changes in [sequences](#) with [loops](#) was fixed.
- [Highlight Current Event](#) on the [Play menu](#) is supposed to control whether or not the current event is displayed with a thick border (as if it were the selection) during play. It did so, but it also mistakenly controlled whether the selection was displayed or not while play was *not* happening.
- If a [musical sequence's](#) media file did not have its "Ready for Archiving" flag turned on (in the file's properties in Windows Explorer), the [Sequence Editor](#) would not play the [sequence](#), complaining that the media file could not be found.
- If the [Sequence Editor](#) played a [musical sequence](#) at [quarter, half, double or quadruple speed](#), and the directory its media file was in contained a period in its name, sometimes the wrong media file would be played.

What's New in Version 2.0.12

This release fixes the following issues:

- A [show](#) would pause indefinitely if the [Show Player](#) was asked to play a [musical sequence](#) whose media file was missing.
- [Musical sequences](#) played during the [startup](#) and [shutdown](#) sections of a [show](#) would control the

- lights, but would not play audio.
- Commands for [X10 channels](#) were often getting lost.

What's New in Version 2.0.8

This release contains the following bug fixes:

- The [Tapper Wizard's](#) dropdown list allowing you to select the [track](#) to use did not work properly, leading to the taps being put into whatever track had been selected at the time that the Tapper Wizard was opened, rather than into the one that was selected in the list.
- The [VU Wizard's](#) option to operate on only a portion of the song, as opposed to the entire song, did not work properly.
- [Importing channel configuration](#) into a [sequence](#) did not mark that sequence as having unsaved changes.
- Communication with the [controllers](#) is kept alive during the loading of [sequences](#). This is to fix an issue where, after the loading of a large sequence, the PC would have to resynchronize with the controllers due to communication having been paused. This resynchronization could have taken some time, causing strange effects immediately after synchronization.
- If an error occurs while communicating with the [controllers](#), Light-O-Rama tries to reestablish communications, in the hopes that the error was merely a temporary glitch. However, for certain types of errors, it would not try to do so, leading to the communications being permanently down.

What's New in Version 2.0.4

Version 2.0.4 fixes a bug where [X10](#) channels were not being controlled during [shows](#).

What's New in Version 2.0.0

The following new features, changes, and fixes have been made for Light-O-Rama version 2.0.0:

- [Tracks](#)
- [Sequence-in-sequence play](#)
- [Background and foreground effects](#)
- [Universal undo and redo](#)
- [Channel positioning](#)
- [Mouse scroll wheel support](#)
- [Pasting timings between sequences](#)
- [Video playback](#)
- [Intensity and fade presets](#)
- [The Beat Wizard](#)
- [The VU Wizard](#)
- [Recording of individual instruments in the MIDI Wizard](#)
- [Multiple Light-O-Rama networks](#)
- [More media support](#)
- [Animator background image](#)
- [The Channel Property Grid](#)
- [Pasting effects: by time or by cell](#)
- [Holiday Lights Designer support](#)
- [XML sequence files](#)
- [Microsoft Windows Vista support](#)
- [Animator window CPU usage decreased](#)
- [Animator's maximum rows and columns increased](#)

- [Sequence Editor's keyboard support improved](#)
- [New look for the shimmer effect](#)
- [Channel settings form directly accessible via the channel's button](#)
- [Bug fixes and internal improvements](#)

Tracks

Previously, a [sequence](#) was composed of [channels](#), [loops](#), and [timings](#). Now, instead, a sequence is composed of [tracks](#). Tracks, in turn, have channels, loops, and timings.

Two tracks in the same sequence can have different channels, or they can share channels with each other. They have different sets of loops and timings than each other. In an [animation sequence](#), tracks can be of different lengths than each other.



Two tracks, with the same channels, in one sequence

A brief example of how this may be useful:

In a [musical sequence](#), you may want to have some timings representing a bass drum, other timings representing a guitar, and yet another representing something totally unrelated to the song. Before tracks, in Light-O-Rama version 1, you could add all of these timings to your sequence, but it might be difficult to remember, while building the sequence, which timings were for which purpose. The more unrelated timings that you added to the sequence, the more confusing the sequence as a whole would become.

Now in Light-O-Rama version 2, instead, you can build a single sequence with multiple separate tracks, each with only one of those sets of timings, making each set of timings cleaner and simpler to understand. Plus, you can share channels between two or more tracks, have different channels in different tracks, or both.

Sequences are initially created with a single track. Another track can be added via the [Edit menu's](#) "[Add New Track](#)" or "[Duplicate Track](#)" items (the latter of which will share all channels in the current track with the new track), or via new items on the [channel buttons' popup menus](#) ("[Copy to New Track](#)" and "[Move to New Track](#)").

To share an individual channel between multiple tracks, do *not* simply set two different channels to

use the same unit number, circuit number, et cetera, as this will likely have unexpected and undesired results. Instead, use the "[Copy to New Track](#)" or "[Copy to Track Number ...](#)" function on the [channel's popup menu](#):

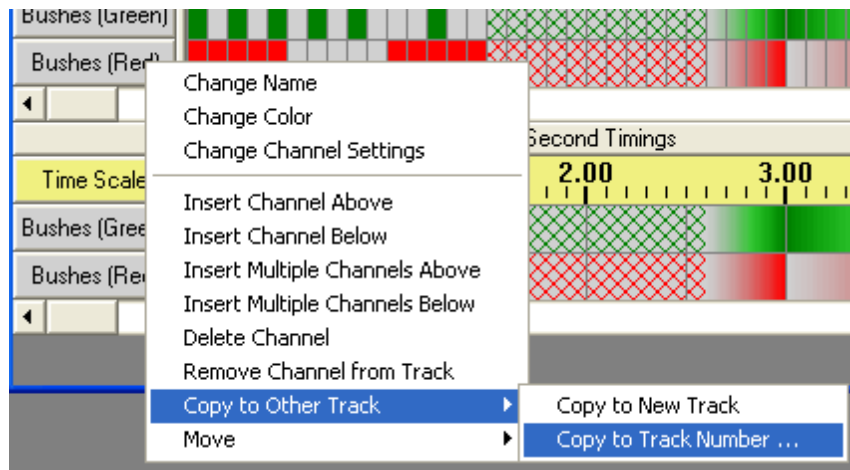

Share a channel with another track by copying it to the other track

If a sequence has more than one track, the tracks are separated in the display by a [track bar](#), labelled (for example) "Track 1" or "Track 2". If the track has been given a name, it will also be displayed here (for example, "Track 2: Front Yard Mini-trees"). Clicking on this bar gives a [popup menu containing various track-related items](#):

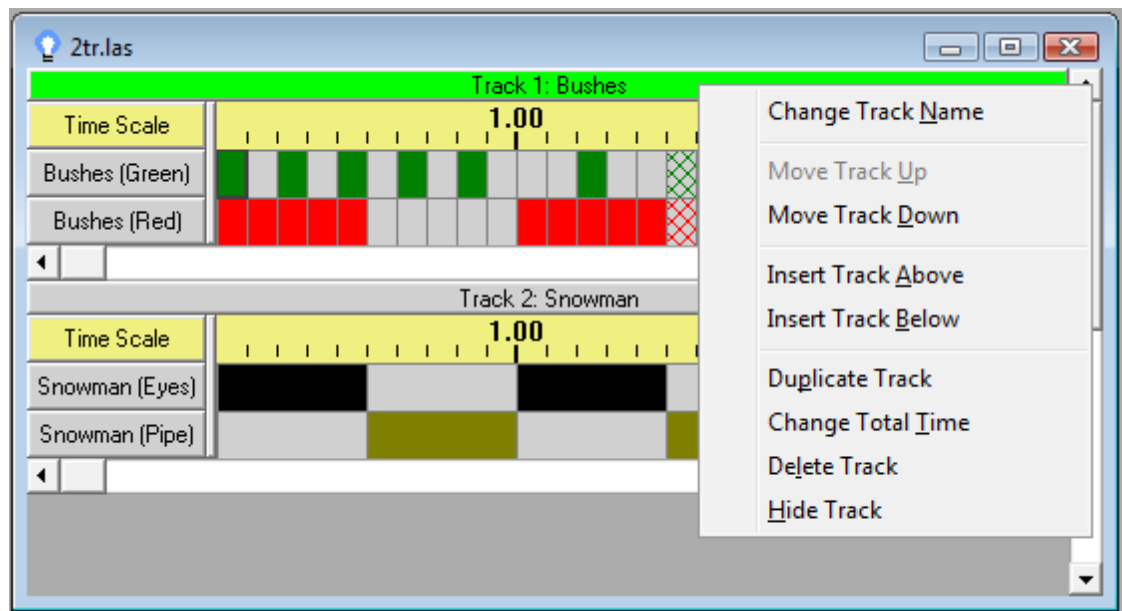

Click on a track bar for various track-related menu items

Sequence-in-Sequence Play

A [channel](#) in a [sequence](#) can now be set to represent another sequence (rather than representing a physical circuit), known as a "[subsequence](#)". This is done in the [Channel Settings](#) dialog, by changing the "Device Type" to "Sequence" (rather than to "Light-O-Rama Controller", "Digital IO Card", or so forth), and choosing the filename of the sequence in the "Sequence" box:

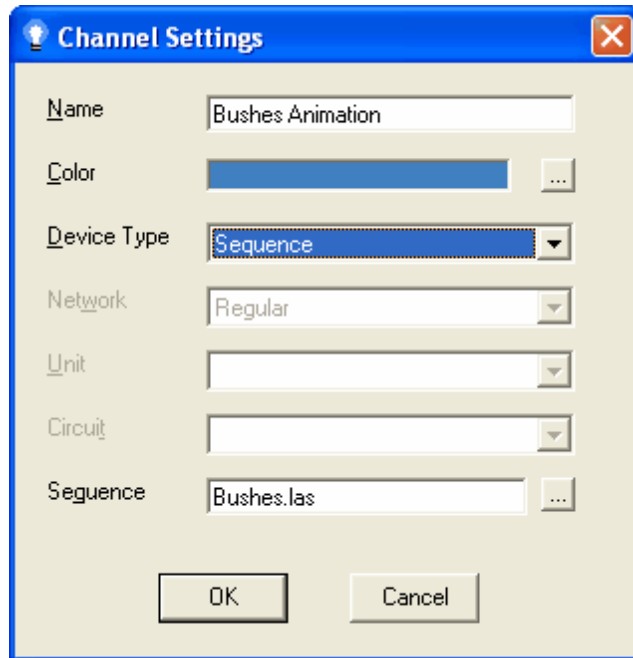

Channel settings for sequence-in-sequence play

A subsequence will play only when the channel that it is a subsequence of is turned on, and will continue playing as long as the channel is on. If the channel is turned off and then turned back on, the subsequence will start over from its beginning.

TIP: Don't try to control the same physical circuit with both a channel in a subsequence and a channel in the main sequence. Doing so will probably cause unexpected results, as the two channels will vie for control of the circuit.

Background and Foreground Effects

Turning on [background effects or foreground effects](#) in the [Sequence Editor](#) will affect the behavior of tools (such as "[Fade Up](#)", "[Twinkle](#)", "[Set Intensity](#)", et cetera) in the following manner:

If "Background Effects" has been turned on, the tool only applies to those selected cells that are completely off (that is, at intensity zero for their entire duration).

If "Foreground Effects" has been turned on, the tool only applies to those selected cells that are *not* completely off.

Some examples:

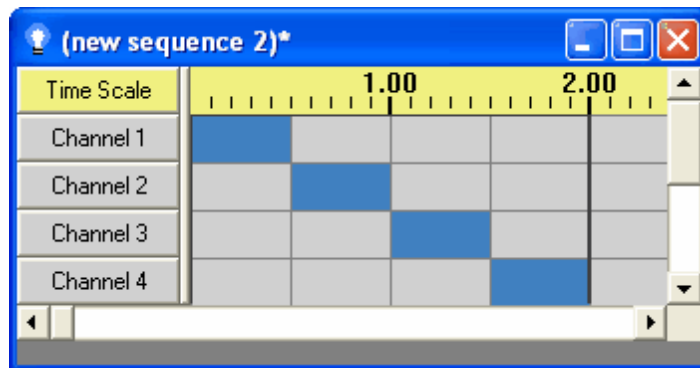

Before a background fade up

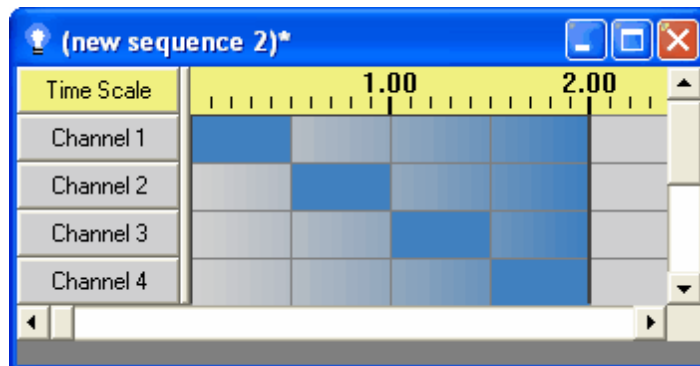

After a background fade up

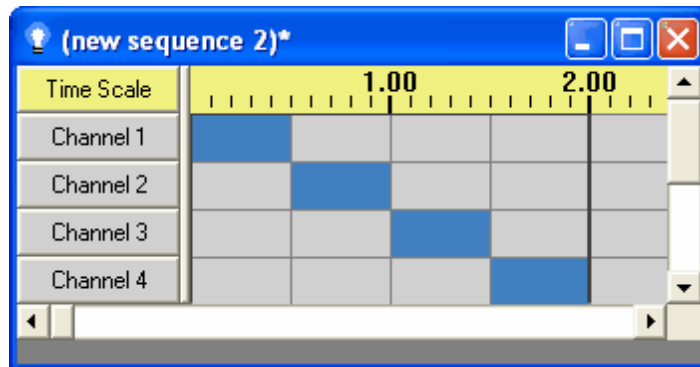

Before a foreground fade up

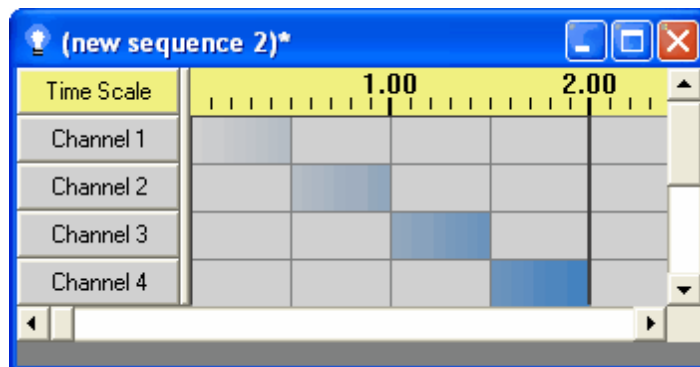

After a foreground fade up

Universal Undo and Redo

The [Sequence Editor](#)'s [undo and redo](#) used to only work for the [effect tools](#) (such as "on", "off", "fade up", "twinkle", and so forth). You can now undo and redo a much wider variety of things - adding [channels](#), moving [timings](#), changing [loops](#), drawing in the [Animator](#), and many others.

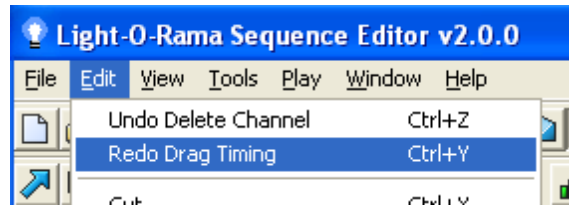

Examples of things that can be undone and redone

Channel Positioning

[Channels](#) can now be moved up and down in the [Sequence Editor](#). There are two ways to do this: First, the [channel buttons' right-click popup menu](#) now includes "[Move Up](#)" and "[Move Down](#)", which will move the channel by one spot. Second, a [channel button](#) can now be mouse dragged to a new position.

Mouse Scroll Wheel Support

The [mouse](#) scroll wheel now works in the [Sequence Editor](#). Scrolling with the wheel causes the displayed [channels](#) in the active sequence to scroll.

Pasting Timings between Sequences

Previously, [timing](#) ranges [copied](#) from a [sequence](#) could only be pasted into that same sequence. Now, a timing range copied from one sequence can be pasted into a different sequence.

Video Playback

The [Show Player](#) and the [Sequence Editor](#) can now use video files (in addition to the previously available audio files) to create [sequences](#). The video output can be displayed during play.

In the Sequence Editor's [Edit/Preferences](#) menu, there is now a new item called "[Video Preferences](#)", which gives control over how video files will be used (both in the Sequence Editor and during [scheduled shows](#)):

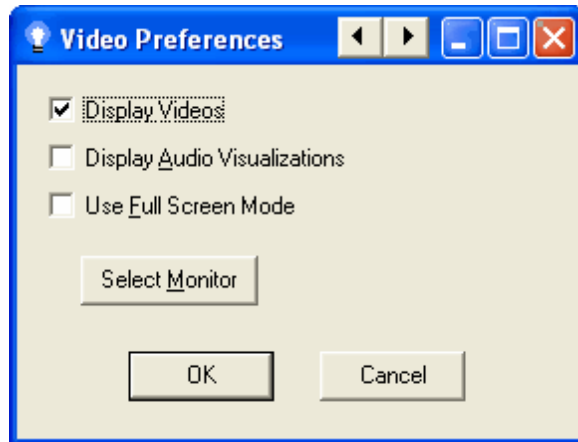

Edit/Video Preferences

These options can also be temporarily changed in the Sequence Editor via the [View/Video](#) menu. However, changes made this way will only affect the Sequence Editor (not the Show Player), and will only last during the current use of the Sequence Editor - that is, the next time that the Sequence Editor is started, the video preferences as set in "Edit/Preferences/Video Preferences will be used again).

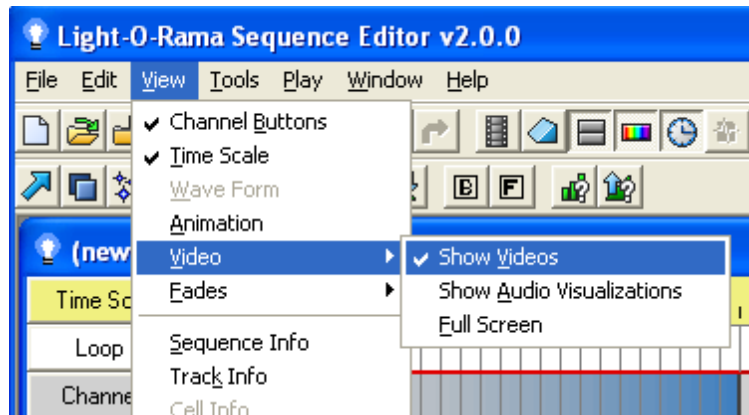

View/Video

Intensity and Fade Presets

The [Sequence Editor's](#) [Set Intensity](#), [Fade Up](#) and [Fade Down](#) tools now have ten preset values (or ranges). The old "Tool Options" dialog was replaced with the [Fade Tool Settings](#) and [Intensity Tool Settings](#) dialogs to set these presets:

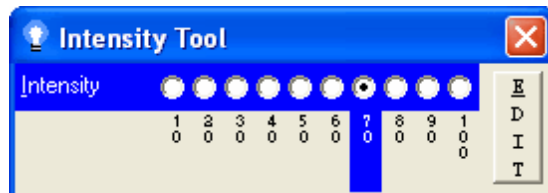

Intensity Settings, with 70% selected

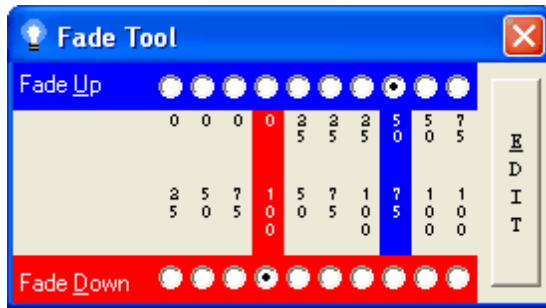

Fade Settings, with fade up 50-75% and fade down 100-0% selected

The Sequence Editor comes with default preset values (such as 10%, 20%, and so forth) build in; if you want to change any of the presets, you can do so by clicking the settings tool's "EDIT" button:

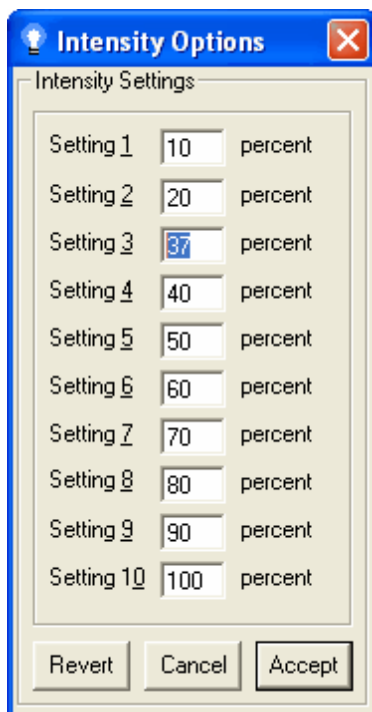

Changing an intensity preset to 37%

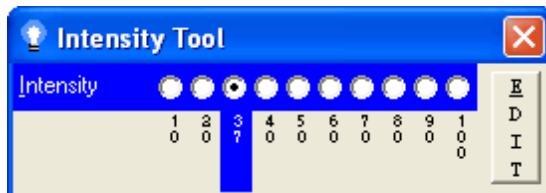

The preset has now been changed to 37%

The values of the presets for both intensities and fades can also automatically be set using [Load Intensities and Fades from Current Sequence](#), of the [Tools menu](#). This will figure out the most commonly used percentages for both intensities and fades existing in the current [sequence](#), and set the preset values to them.

The Beat Wizard

The [Sequence Editor](#)'s new [Beat Wizard](#) can be used to automatically analyze a song to try to determine its beat, and to populate a [musical sequence](#) with [timings](#) or [effects](#) based upon that beat. The Beat Wizard can be found in the Sequence Editor's [Tools menu](#). It is also available as one of the options for [creating a new musical sequence](#), and for [creating a new track](#).

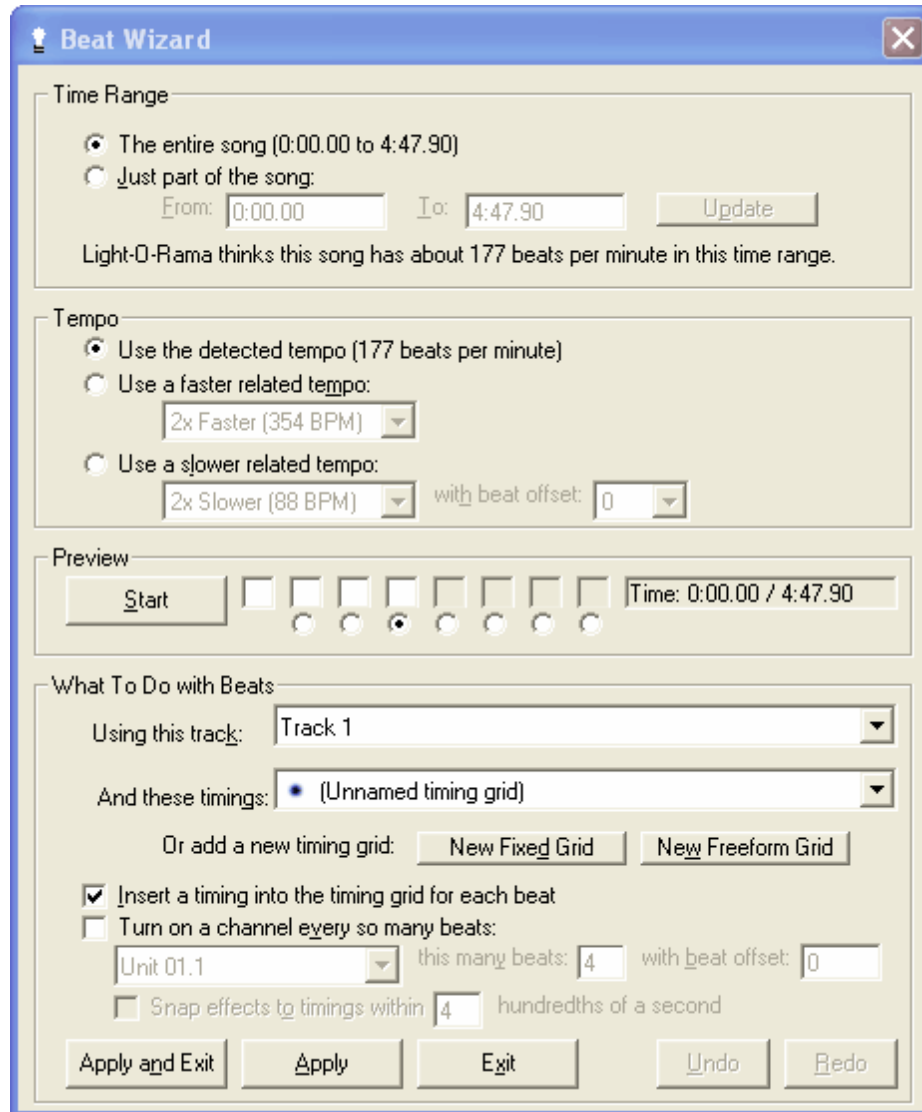

The Beat Wizard

The VU Wizard

The [Sequence Editor](#)'s new [VU Wizard](#) is a VU meter-like tool that can be used to automatically populate a [musical sequence](#) based upon peaks in the audio. The VU Wizard can be found in the Sequence Editor's [Tools menu](#), and is also available as one of the options for [creating a new musical sequence](#), and for [creating a new track](#).

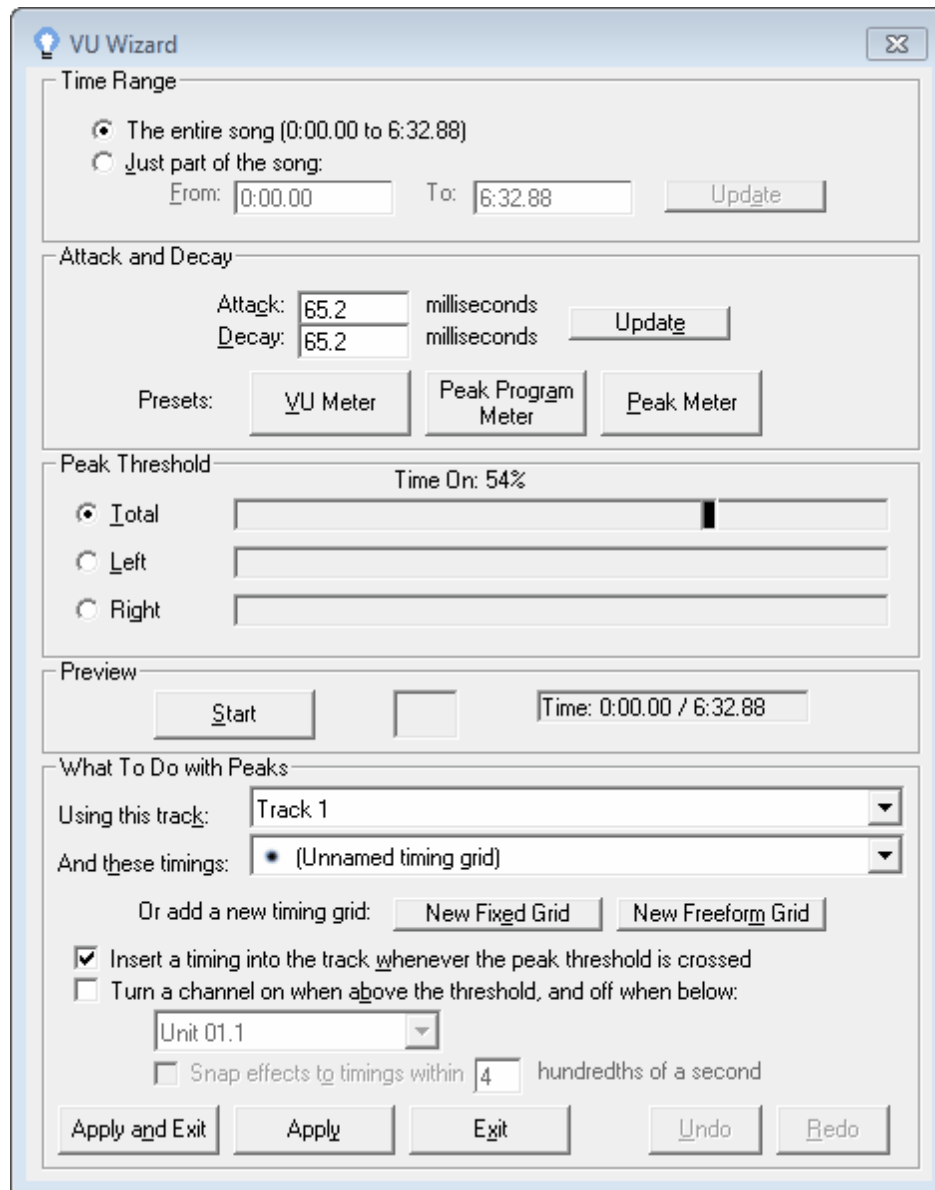

The VU Wizard

Recording of Individual Instruments in the MIDI Wizard

The [MIDI Wizard](#) can now automatically create lighting [effects](#) for a [musical sequence](#) based on the notes played by individual instruments in a MIDI file.

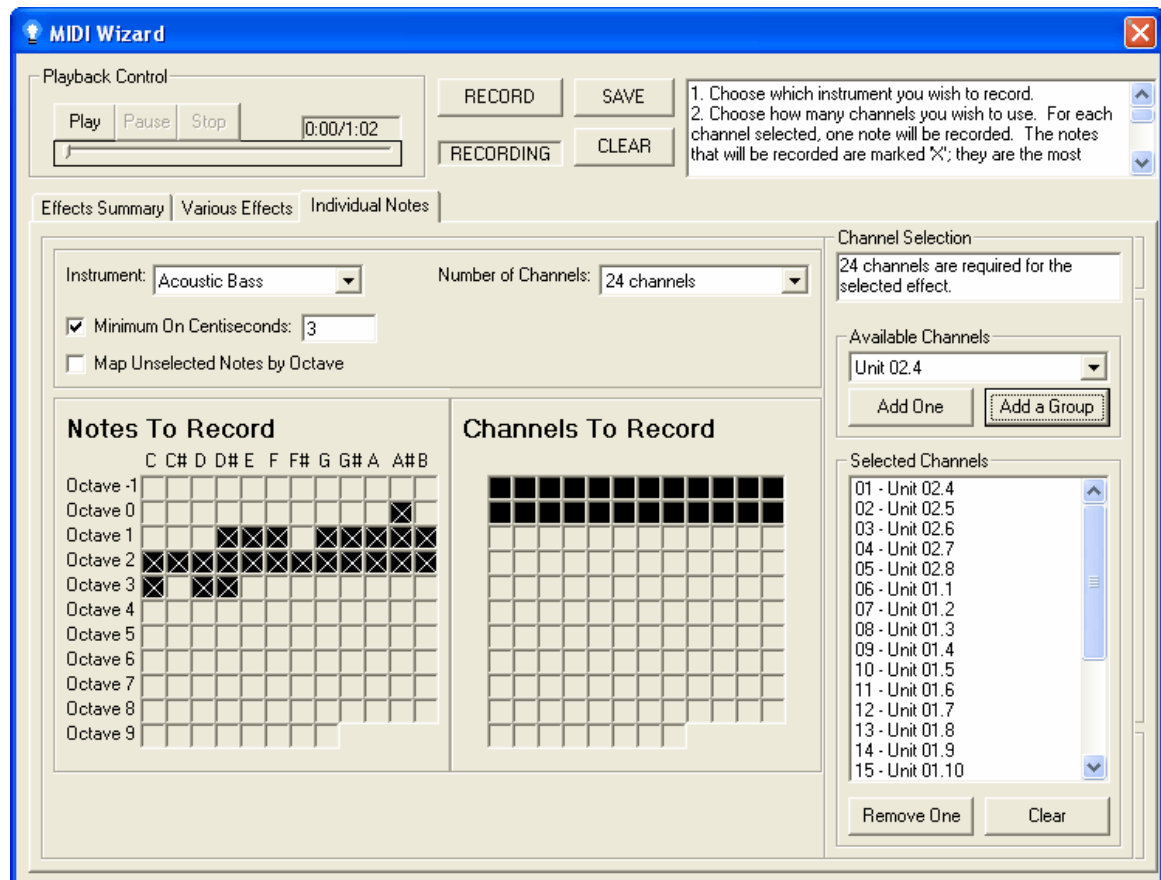

The MIDI Wizard's can automatically create lighting effects based on the notes played in a MIDI file

Multiple Light-O-Rama Networks

Previously, only a single COM port could be used for Light-O-Rama controllers. Now, up to four [Light-O-Rama networks](#) can be used simultaneously on the same computer, on different COM ports.

The same unit and circuit number can be used on multiple networks simultaneously and independently, with different effects happening on the different networks.

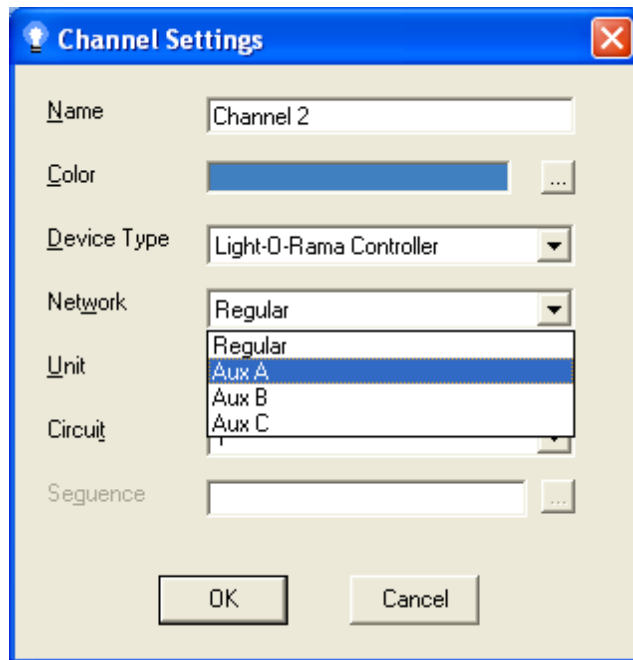

Up to four different networks can be used for LOR controllers

More Media Support

Various new media file types (including Windows Media Files and certain types of videos) are now supported for [musical sequences](#).

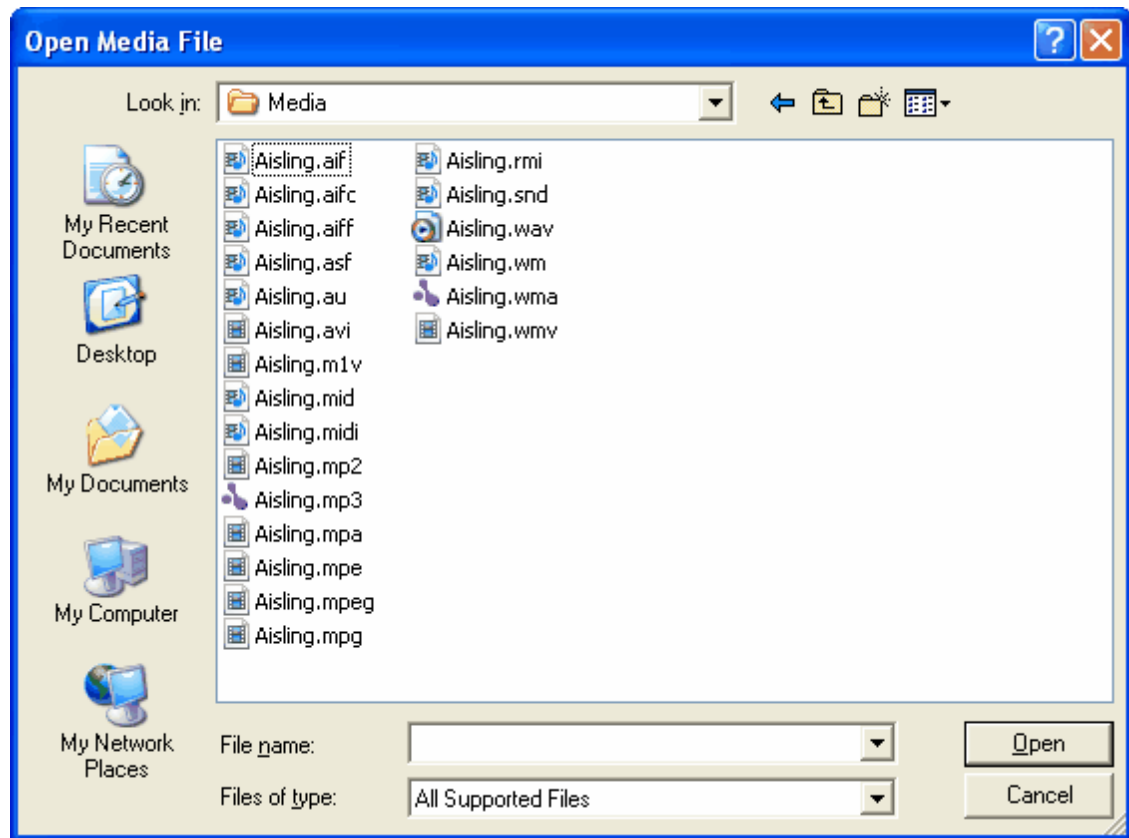

Various supported media types

Animator Background Image

A [sequence's](#) [animation](#) can now be set up to have a background image, such as a picture of a house on which Christmas lights are to be placed.

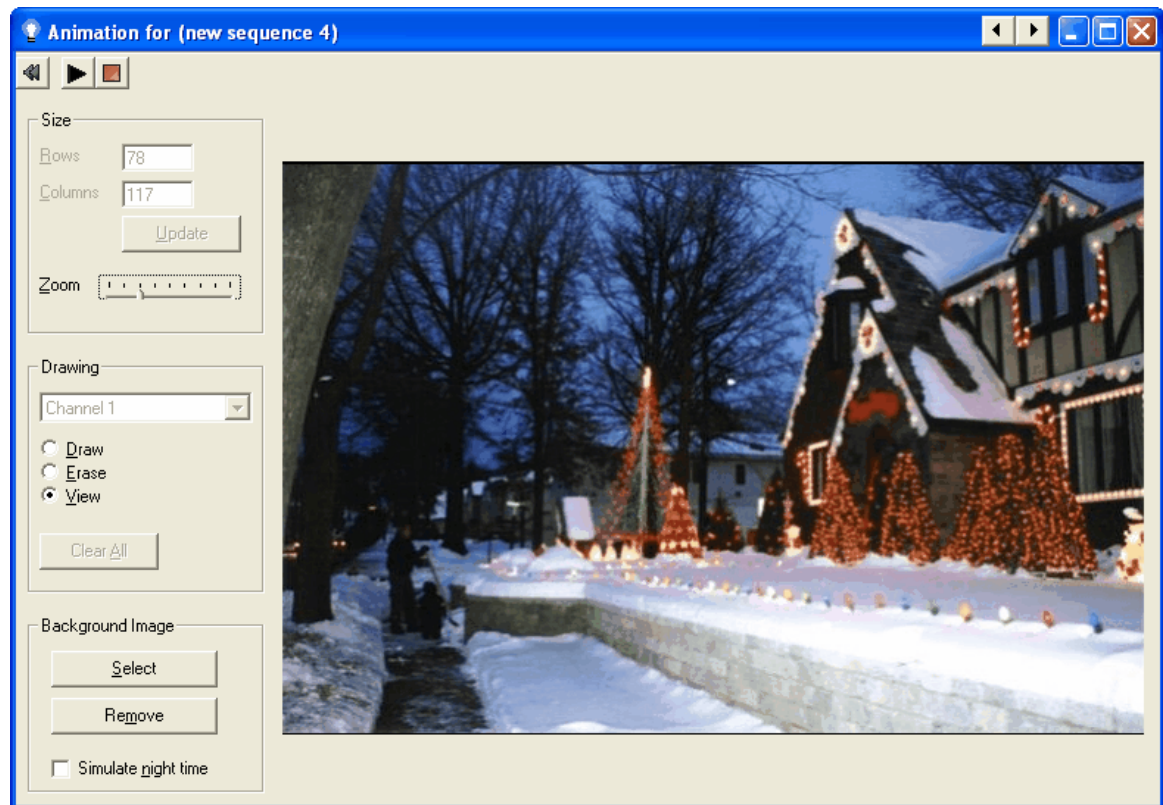

The Animator, with a background image

The Channel Property Grid

The [Sequence Editor's](#) new [Channel Property Grid](#) is a window showing information about all of the channels in a sequence (their color, device type, unit number, et cetera), and allowing changes to those properties in a (hopefully) convenient manner. This can be accessed via the Sequence Editor's [Tools menu](#).

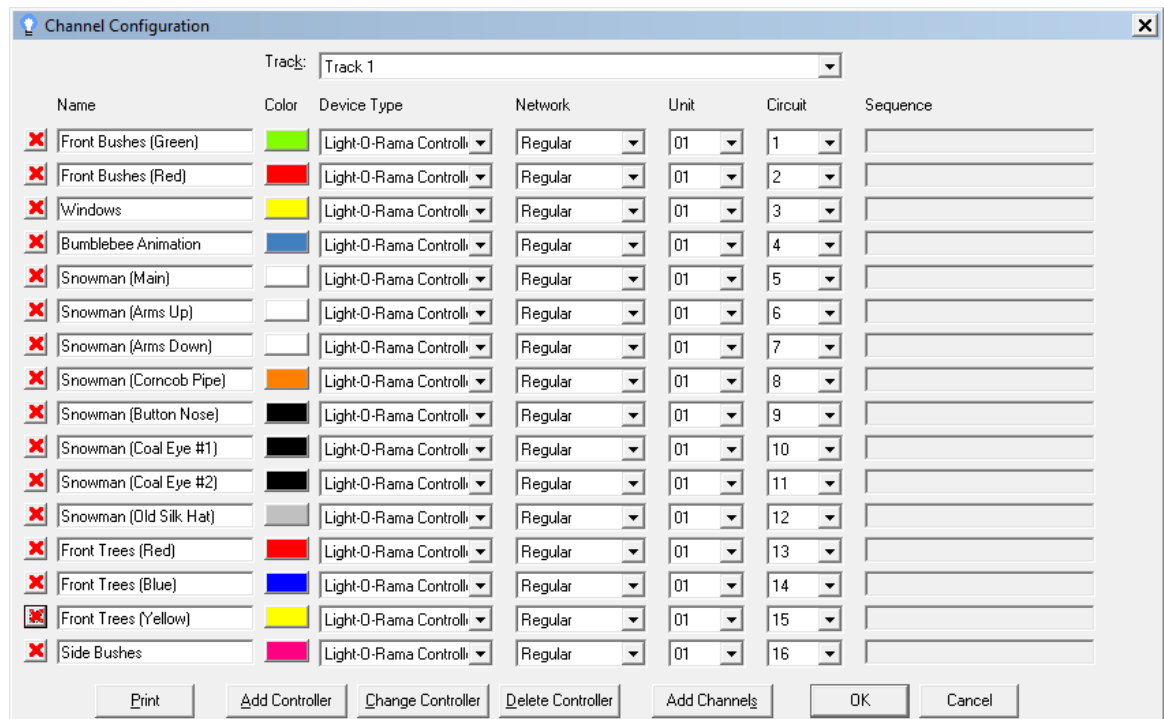

The Channel Property Grid

Pasting Effects: By Time or By Cell

When pasting [effects](#) in the [Sequence Editor](#), you can now choose to insert the events into the destination based upon either the length of the copied events or else the relative lengths of the copied and destination cells.

For example, consider timings at 0 seconds, 1 second, and 2 seconds. Between 0 and 1 is a fade up, and between 1 and 2 is a fade down:

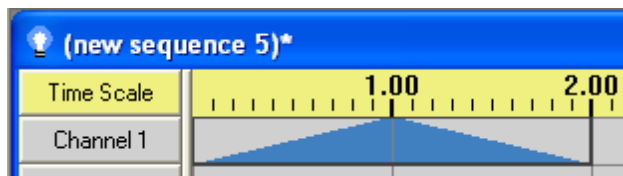

Events to be copied

These events will be copied, and pasted to the time starting at 5 seconds. There are timings at 5 seconds, 7 seconds, and 7.5 seconds:

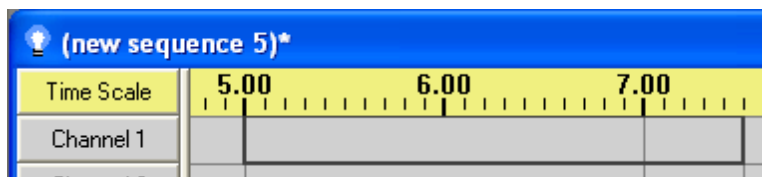

Where they will be pasted to

If "Paste by Cell" is selected, then there will be a fade up from 5 to 7, and a fade down from 7 to 7.5 (this is the same way that pasting always behaved in version 1 of Light-O-Rama):

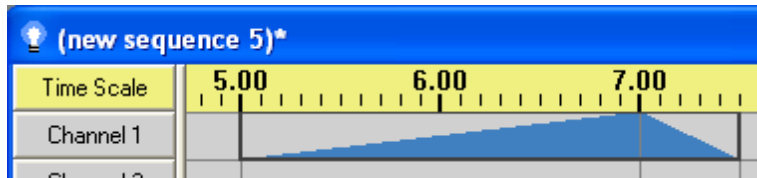

After pasting by cell

If "Paste by Time" is selected, then there will be a fade up from 5 to 6, and a fade down from 6 to 7. The timings at 7 and 7.5 are ignored; only the original lengths of the events are used:

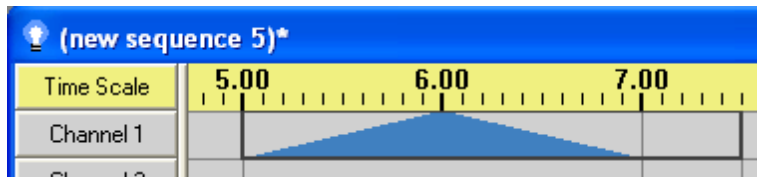

After pasting by time

You can switch between these two modes by selecting "[Set Paste Mode](#)" in the [Sequence Editor's Edit menu](#).

Holiday Lights Designer™ Support

Light-O-Rama can now interact with [Holiday Lights Designer™](#), a third-party application by Holidaysoft®.

Holiday Lights Designer™ can be used to virtually place lights and decorations on images of your home or business, and Light-O-Rama can now send Holiday Lights Designer™ commands during play to make those virtual lights behave as your real lights would during a show.

To send commands to Holiday Lights Designer™, first set the [Holiday Lights Designer Preferences](#) in the [Sequence Editor](#) under the [Edit menu](#). After this is done, commands can be sent from the Sequence Editor by turning on "[Control Holiday Lights Designer](#)" in the [Play menu](#), or from the [Show Player](#) by selecting "Holiday Lights Designer On" in the [Light-O-Rama Control Panel](#).

Version 4.0 or above of Holiday Lights Designer™ is required to take advantage of Light-O-Rama interaction.

For more information about Holiday Lights Designer™, please see the [Holidaysoft website](#).

XML Sequence Files

[Sequence](#) files (and [channel configuration](#) files) are now saved as XML files. LOR 2 understands both these new sequence files and the old LOR 1 style sequence files.

If an LOR 1 file is modified and saved by LOR 2, it is automatically updated to the new LOR 2 style. This means that LOR 1 will no longer understand the updated file. However, to be safe, a copy of the original LOR 1 save file is automatically created, and labelled as an LOR 1 file. For example, if the LOR 1 sequence file "lights.las" is converted to an LOR 2 file, then a copy of the original LOR 1 file will be created, named "lights.las.v1.bak".

Microsoft Windows Vista Support

Various changes were made to better support Light-O-Rama on the Microsoft Windows Vista operating system.

Animator Window CPU Usage Decreased

The [Sequence Editor's Animator](#) window now uses significantly less CPU during play than it used to.

Animator's Maximum Rows and Columns Increased

The Animator window now supports up to two hundred rows and columns:

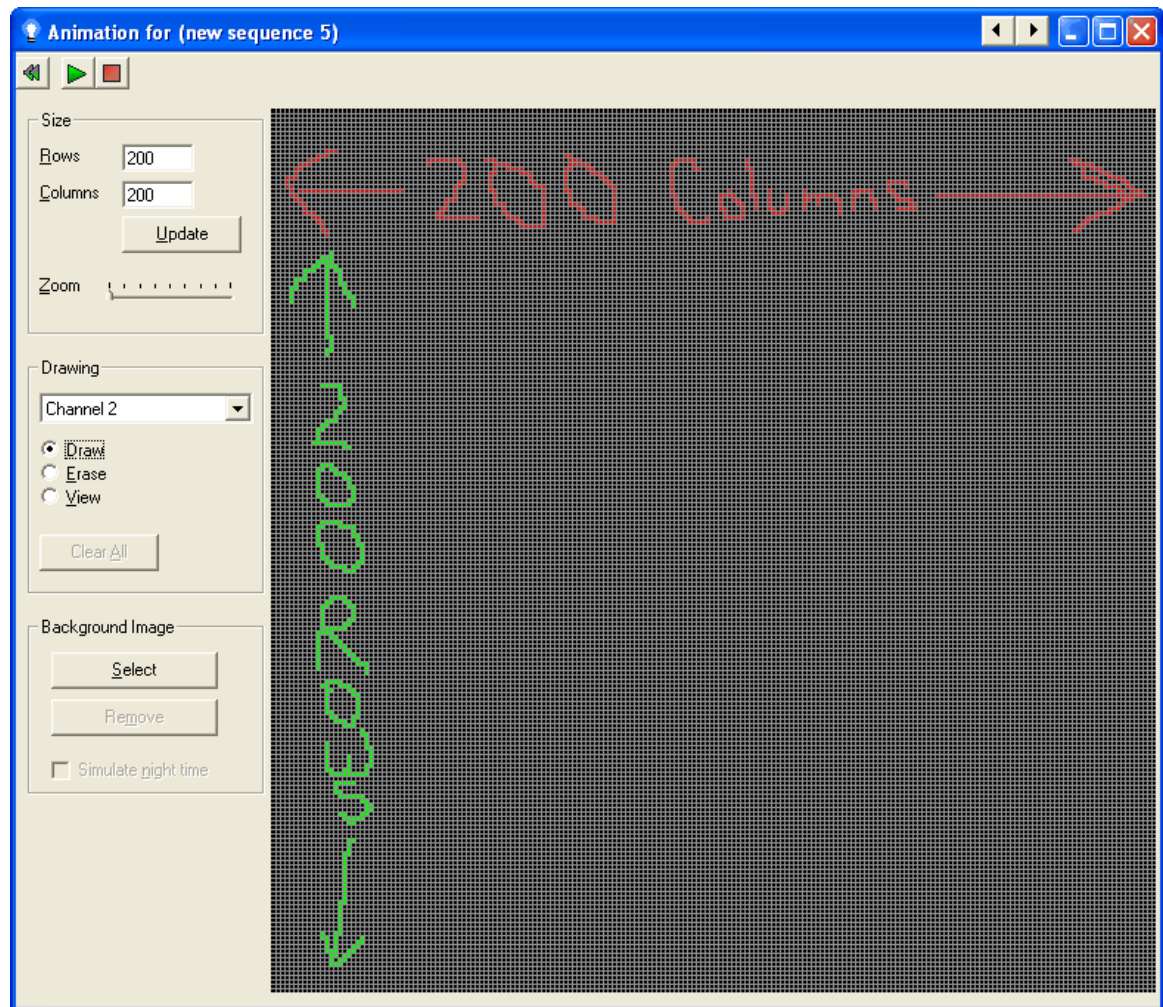

Animation with 200 rows and 200 columns

Sequence Editor's Keyboard Support Improved

Several changes were made to make [using the keyboard](#) easier in the [Sequence Editor](#). For example:

- The "enter" key now chooses the "OK" button on most forms;

- The "escape" key now chooses the "Cancel" button on most forms;
- The "tab" key circulates between controls in a more sane order;
- Many Alt-key shortcuts were added to various forms;
- The various [menus](#) were reorganized so as to cause less conflict among their various items' shortcut hotkeys.

New Look for the Shimmer Effect

The [shimmer](#) effect is now drawn (in the [Sequence Editor](#)) using diagonal lines, instead of the previous vertical lines. This will hopefully make them stand out more against the background of vertical lines which represent [timings](#).

Note that this change is simply for display of the sequence in the Sequence Editor; the actual appearance of the shimmer effect on controlled lights is unaffected by this.

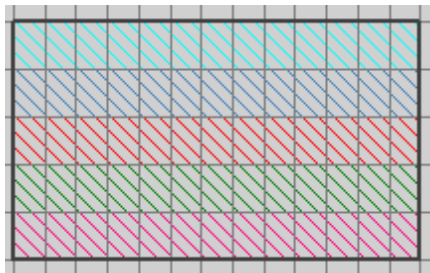

Some channels with shimmer effects

Channel Settings Form Directly Accessible via the Channel's Button

In the Sequence Editor, left-clicking and right-clicking on a channel button used to both bring up a context menu of channel-related functions (such as adding, deleting, and moving channels). Right-clicking still does that, but left-clicking now brings up the channel's settings form instead:

The Channel Settings form

Bug Fixes and Internal Improvements

Several bug fixes have been made, including but not limited to the following:

- If a show includes a musical cleanup sequence, it is supposed to be played after each song. Instead, it was being played only at the end of the show, just before the first shutdown sequence.
- Some musical sequences, when played in the Sequence Editor, would reach the end of their audio file, but would not cause the Sequence Editor to exit from play mode.
- Certain audio files would not play their audio.
- The Sequence Editor incorrectly determined the total length of certain audio files.
- When a musical sequence was played in the Sequence Editor using the "Visible Screen" play range, the display would sometimes jump to an adjacent portion of the sequence, rather than remaining on the initially visible portion of the sequence.
- Attempting to delete the first timing in a sequence (at time zero) would cause the Sequence Editor to crash.
- Attempting to resize multiple timings (simultaneously) using the Sequence Editor's "Resize Timings to ..." function (on the right-click popup menu) would cause the Sequence Editor to crash if the sequence happened to be more than 5:27.67 long.
- When the Sequence Editor displayed fades using gradual changes in colors (as opposed to when it displayed them using ramps), it would sometimes draw the end of a fade event past where it should have been.
- The Tapper Wizard's option to not use a countdown before the song begins did not work.
- When a sequence was playing at a speed other than the normal speed (for example, through the "Play Speed" menu item in the Sequence Editor, or due to a loop that was set up to increase or decrease speed each time through), if a fade up or a fade down was done, the lights would not properly take the speed of the sequence into account when determining how quickly to fade. For example, a fade up from 0 to 100% that normally takes one second, played at half speed, should fade up from 0 to 100% in two seconds. Instead, it would fade up from 0 to 100% in the first second, and then remain at 100% for the entire second second.
- When the Cleanup or Delay portion of a show was modified in the Show Editor, the Save button would not become enabled.
- The Sequence Editor's audio waveform display (and its positioning line) did not exactly match up with the time of the rest of the display. This was especially noticeable at very high zoom levels.
- When moving a timing in a sequence by clicking and dragging it in the Sequence Editor, sometimes the timing *before* the selected one would be moved.
- When a musical sequence was opened in the Sequence Editor, and the "View Wave Form by Default" option was selected, if the sequence's audio file no longer existed (or otherwise could not be opened), the Sequence Editor would crash.
- If a musical sequence was played in the Sequence Editor, and the sequence's audio file no longer existed (or otherwise could not be opened), nothing would appear to happen. The Sequence Editor now instead shows an error message box describing the problem.

Various internal improvements have been made as well.

What's New in Version 1.5.0

The following new features, changes, and fixes have been made for Light-O-Rama version 1.5.0:

- [Tapper Wizard Behavior Change](#)

- [Channel Deletion Fix](#)
- [Channel Button Feedback during Loops Fixed](#)
- [Animator Fix](#)

Tapper Wizard Behavior Change

When the [Tapper Wizard](#)'s "toggle" and "snap to existing events" options are used together, both the beginning time and the end time of each toggle are snapped to existing events. This causes the combination to behave in a way that is probably more similar to what most people would expect.

Channel Deletion Fix

Various problems occurred when the last [channel](#) in a [sequence](#) was deleted. These have been fixed.

Channel Button Feedback during Loops Fixed

When the [Sequence Editor](#) was used to play a [sequence](#) with a [loop](#), and the end of the loop was reached, just before going back to the beginning of the loop, the [channel buttons](#)' color displays would sometimes briefly act upon the event just after the loop. This has been fixed. Note that it did not affect the actual display of lights; it only affected the display within the Sequence Editor itself.

Animator Fix

If the [Animator](#) was sized so that scroll bars were necessary, the "draw" and "erase" functions would act upon the wrong cells. This has been fixed.

What's New in Version 1.4.0

- [Time Scale](#)
- [Copy and Paste Timings](#)
- [Animation Saved in Channel Configuration Export](#)
- [Right-Click in Animator Now Erases](#)
- [Duration in Status Bar](#)
- [Play Again](#)
- [Several Zoom Improvements](#)
- [Delete Selected Events](#)
- [Animator Efficiency](#)
- [Manual Stop Stays in Position](#)
- [Program's Main Window Remembers Its Position](#)
- [Bug Fixes and Internal Improvements](#)

Time Scale

In the [Sequence Editor](#), at the top of each sequence, a time scale is optionally displayed. Also, during play, the button to the left of this scale now displays the current time offset.

Whether the time scale is displayed or not for any particular sequence can be controlled via the [View menu](#), or via a button on the [toolbar](#). It can be turned on or off by default using the [Display Preferences](#) dialog on the [Edit menu](#).

Copy and Paste Timings

In the [Sequence Editor](#), you can now copy and paste [timings](#) - that is, make new cells having the same duration and relative positions as some existing timings.

To copy a set of timings, select the range of cells that you want to copy, and then copy them in one of three ways:

- Select "[Copy Timing](#)" from the [Edit menu](#);
- Select "[Copy Timing](#)" from the [right-click context menu](#);
- Using the [keyboard](#), hold the "Shift" key and simultaneously hit the "Delete" (or "Del") key.

Once these timings are copied, you can paste them in one of several ways:

- Via the right-click context menu:
 - "[Paste timing at \(the centisecond that was right-clicked\)](#)";
 - "[Paste timing at ...](#)", which brings up a dialog box asking the centisecond to paste to (defaulting to the centisecond that was right-clicked);
 - "[Paste timing multiple](#)", which is similar, but also asks how many times you would like to paste the timings consecutively, or if you wish to keep pasting them all the way to the end of the file.
- Via the Edit menu, using "[Paste Timing](#)". This is the same as the right-click menu's "Paste timing multiple", except that the starting centisecond defaults to the start of the current selection, rather than the right-clicked centisecond.
- Using the keyboard, hold the "Shift" key and simultaneously hit the "Insert" (or "Ins") key. This is the same as "Paste Timing" from the Edit menu.

Animation Saved in Channel Configuration Export

When a [sequence's](#) channel configuration is saved (using "[Export Channel Configuration](#)" from the [Edit menu](#) of the [Sequence Editor](#)), the sequence's [animation](#) is saved along with it. When the channel configuration is later imported into another sequence (using "[Import Channel Configuration](#)" from the same menu), the user is given the option to import the animation as well.

Right-Click in Animator Now Erases

The right mouse button can now be used to erase cells in the [Animator](#).

Duration in Status Bar

The status bar along the bottom of the [Sequence Editor](#) now shows not only the total time and selected time range, but also the duration of the selected time range.

Play Again

You can now tell the [Sequence Editor](#) to "play again". This causes it to play the last thing that you asked it to play, regardless of the current play settings. For example, if you choose a certain time range, with the play range set to "Selection", the Sequence Editor will play that selection. After play ends, you may fix some problem that you noticed, which causes the selected time range to change. If you wanted to play the same time range again, previously, you would have to re-select that time range. Now, you can instead simply hit "Play Again".

There are two ways to do this: Via the "[Play Again](#)" item of the [Play menu](#), and via a new [toolbar](#)

button.

Several Zoom Improvements

Several zoom improvements have been made in the [Sequence Editor](#):

- The "Zoom In" and "Zoom Out" buttons on the [toolbar](#) have been replaced by individual buttons for "Zoom Channels In", "Zoom Channels Out", "Zoom Time In", and "Zoom Time Out".
- Preferred zoom settings can now be saved or restored via the [Zoom Preferences](#) dialog on the [Edit menu](#). The saved zoom preferences are used by default when opening or creating new sequences.
- [Keyboard](#) shortcuts now exist to zoom in various directions: Alt-Up and Alt-Down to zoom channels in and out, and Alt-Left and Alt-Right to zoom time in and out. Also, Alt-Page-Up and Alt-Page-Down to go to the minimum or maximum channel zoom settings, and Alt-Home and Alt-End for the minimum and maximum time zoom settings.

Delete Selected Timings

In the [Sequence Editor](#), several [timings](#) can now be deleted at once, by selecting a range of timings and choosing "[Delete Selected Timings](#)" from the [right-click context menu](#).

Animator Efficiency

The [Animator](#) has been made more efficient, using less CPU during play. This improves the jerkiness that was seen on some machines during play while the Animator window was open.

Manual Stop Stays in Position

When you manually stop play of a [sequence](#) (as opposed to letting it stop by reaching its natural end), the [Sequence Editor](#) now continues to display the screen that was being displayed when play was stopped.

Program's Main Window Remembers Its Position

When you start the [Sequence Editor](#), its main window is now opened in the same position that it was in the last time it was closed.

Bug Fixes, Internal Improvements

Several bug fixes and internal improvements have been made.

3 Feature Comparison

The [Light-O-Rama software package](#) must be registered, with a valid license, in order to be used to its full potential. Each license contains two separate types of license levels: the main license level and the SuperStar license level.

The main license level covers all of the Light-O-Rama software package except for the [Light-O-Rama SuperStar Sequencer](#). Several different main license levels exist, each having different features: Basic,

Basic Plus, Standard, and Advanced. Additionally, there is an unlicensed Demo version (which is the same as the Basic version, except that it cannot be used to actually control lights, and has encrypted save files).

The SuperStar license level covers the Light-O-Rama SuperStar Sequencer. Its possible levels are called 2_CCR, 4_CCR, 8_CCR, and 24_CCR, indicating the number of Cosmic Color Ribbons you can use with SuperStar. Additionally, there is an unlicensed Demo version which does not allow export to an actual [sequence](#).

Any reference in this help file to a "license level" or "feature level" refers to the main license level, not to the SuperStar license level, unless specifically noted otherwise.

You will be given a chance to [register your Light-O-Rama software](#) at the time that you install it. To register after that time, or to upgrade to a higher level license, please see the "[Register Light-O-Rama](#)" (or "Upgrade Light-O-Rama") menu item on the [Sequence Editor's Help menu](#), or on the [Control Panel's popup menu](#).

The following chart summarizes what features are available with each license level, with detail on each coming after the chart.

If a feature is listed as "(demo mode)", it means that the feature can be used with this license to see what it's like, but it won't be fully supported. For example, if you try one of the Sequence Editor's demo mode features while building a [sequence](#), you won't be able to save your changes to that sequence. Please see the details for each feature for exactly what "demo mode" means for that feature.

Any features not listed here are available with all license levels.

FEATURE	DEMO	BASIC	BASIC PLUS	STANDARD	ADVANCED
Number of LOR Units Supported	0	2	4	8	UNLIMITED
Number of Tracks Supported	2	2	2	4	UNLIMITED
Full Access XML Data Storage	No	YES	YES	YES	YES
Beat Wizard	(demo mode)	(demo mode)	YES	YES	YES
VU Wizard	(demo mode)	(demo mode)	YES	YES	YES
Video Playback (Windowed Mode)	No	No	YES	YES	YES
Show On Demand	No	No	YES	YES	YES
Schedule Shows Based on Day of Year	(demo mode)	(demo mode)	YES	YES	YES
Startup Sequences in Shows	(demo mode)	(demo mode)	(demo mode)	YES	YES
Shutdown Sequences in Shows	(demo mode)	(demo mode)	(demo mode)	YES	YES
Background Sequences in Shows	(demo mode)	(demo mode)	(demo mode)	YES	YES

FEATURE	DEMO	BASIC	BASIC PLUS	STANDARD	ADVANCED
Sequence in Sequence	(demo mode)	(demo mode)	(demo mode)	(demo mode)	YES
MIDI Wizard	(demo mode)	(demo mode)	(demo mode)	(demo mode)	YES
Triggered Interactive Sequences	(demo mode)	(demo mode)	(demo mode)	(demo mode)	YES
Show Startup Options	No	No	No	No	YES
Execute Windows Shell Commands	No	No	No	No	YES
Full Screen Video Playback	No	No	No	No	YES
Multiple Networks	No	No	No	No	YES
Create Protected Sequences	No	No	No	No	YES
DMX Intensity	No	No	No	No	YES
Native DMX Devices Supported	No	No	No	No	YES
Dasher Controllers Supported	No	No	No	No	YES
X10 Controllers Supported	No	No	No	No	YES
Digital IO Cards Supported	No	No	No	No	YES
BSOFT Digital IO Cards Supported	No	No	No	No	YES

Number of LOR Units Supported

Except for the Advanced license level (which supports an unlimited number of [Light-O-Rama controllers](#)), each license level will send [lighting commands](#) to a limited number of Light-O-Rama controllers: Basic supports a single controller, Basic Plus supports four, and Standard supports eight.

Whether a particular controller is supported or not depends on its [unit ID](#). For example, the Basic license level will send lighting commands only to unit ID numbers 1 and 2, while the Standard license level will send lighting commands to any unit that has a unit ID between 1 and 8.

Regardless of whether a particular unit will be sent lighting commands, you can always use the [Sequence Editor](#) to build [sequences](#) using that unit; Light-O-Rama simply will not control the lights for that unit unless you upgrade to a higher license level.

The unlicensed Demo version will not send lighting commands to any controllers, so you cannot use it to actually control your lights.

Number of Tracks Supported

A [sequence](#) may have multiple [tracks](#); however, certain license levels will only support a limited number of tracks in any given sequence. The Demo, Basic, and Basic Plus levels support two

tracks per sequence, Standard supports four, and Advanced supports an unlimited number of tracks per sequence.

You will not be able to add new tracks to a sequence if it already has the maximum supported number. However, you can still open sequences that have more tracks (for example, a sequence that was created by someone who has a higher license level than you do). In this case, the extra tracks will be displayed in the Sequence Editor, but you will not be able to modify them, and any [lighting effects](#) in those tracks' [channels](#) will not actually control your lights during play.

Full Access XML Data Storage

When a [sequence](#) is saved using a licensed version of Light-O-Rama, its save file uses a standard XML format, which is designed to be understandable by people. Technically advanced users may feel comfortable editing these XML-based sequence files directly with a text editor, or even building their own tools that can be used with these files (although *please* be careful when doing so, as it is not terribly difficult to make a small mistake which may render the sequence file incomprehensible to the Light-O-Rama software package).

On the other hand, when a sequence is saved using the unlicensed Demo version, it is saved encrypted, and so the file itself cannot be easily understood or modified by anyone or anything except the Light-O-Rama software package. Additionally, data from an encrypted sequence cannot be copied and pasted, except on the computer that the sequence was originally encrypted on.

No matter whether a sequence is saved using the open XML format or using encryption, the Light-O-Rama software itself will still be able to use it.

If you create an encrypted sequence using the unlicensed Demo version, and later purchase a license, you can unencrypt the sequence by resaving it on the same computer it was originally encrypted on, using your licensed version of the software.

Beat Wizard

The [Beat Wizard](#) can be used to analyze a song to try to determine its tempo, and to automatically place [timings](#) and [lighting effects](#) into a [sequence](#) based upon that tempo. It is fully supported in license levels Basic Plus, Standard, and Advanced.

It is *not* supported in license level Basic (nor in the unlicensed Demo version). However, you can still try it out in a "demo mode" to see what it is like; after trying it on a sequence, you will not be able to save your changes. You will be given a warning about this when you try it, along with a chance to back out before committing to using it. Additionally, if you do decide to use it, and your sequence already has unsaved changes, you will be given a chance to save them before you actually use this feature.

VU Wizard

The [VU Wizard](#) can be used to analyze a song to find peaks in the audio - much like a VU meter - and to automatically place [timings](#) and [lighting effects](#) into a [sequence](#) based upon those peaks. It is fully supported in license levels Basic Plus, Standard, and Advanced.

It is *not* supported in license level Basic (nor in the unlicensed Demo version). However, you can still try it out in a "demo mode" to see what it is like; after trying it on a sequence, you will not be able to save your changes. You will be given a warning about this when you try it, along with a

chance to back out before committing to using it. Additionally, if you do decide to use it, and your sequence already has unsaved changes, you will be given a chance to save them before you actually use this feature.

Video Playback (Windowed Mode)

You can build [musical sequences](#) based on audio files (such as MP3) or on video files (such as WMV). When a musical sequence is played, the sound will always play, but the actual video (or audio visualization) will only be displayed for license levels Basic Plus, Standard, and Advanced. License level Basic will not display video (or audio visualization).

Additionally, your license level may or may not support video playback in full screen mode; see "[Full Screen Video Playback](#)" for details.

Show On Demand

Using license level Basic Plus or above, you can cause a [show](#) to be played without having [scheduled](#) it. This is done via the "[Show On Demand](#)" menu item of the [Light-O-Rama Control Panel's popup menu](#).

Schedule Shows Based on Day of Year

The Light-O-Rama [Schedule Editor](#) can be used to [schedule shows](#) to play in two different ways: [by the day of the week](#) (such as "from 6:00 PM to 9:00 PM on Friday") or [by the day of the year](#) (such as "from 9:00 AM to 9:00 PM on December 25th").

However, scheduling based on the day of the year is fully supported only in license levels Basic Plus, Standard, and Advanced.

Using the Basic license level, you will still be able to use the Schedule Editor based on the day of the year in a sort of "demo mode" to see what it is like, but the Light-O-Rama [Show Player](#) will not actually play shows that are scheduled this way - it will only play shows that were scheduled by the day of the week.

Startup Sequences in Shows

The Light-O-Rama [Show Editor](#) can be used to build [shows](#) with several different sections. Among these is the [Startup Section](#). [Sequences](#) in the Startup Section are played immediately upon the show starting up, one at a time, in order. After all of them have been played, the main portion of the show (i.e. the [Animation Section](#) and the [Musical Section](#)) begins.

However, this section is fully supported only with the Standard and Advanced license levels.

Using the Basic and Basic Plus license levels, you will still be able to use this section in the Show Editor in a sort of "demo mode", to see what it is like. However, the Light-O-Rama [Show Player](#) will not actually play the sequences in a show's Startup section; instead, the show will simply begin play directly with the Animation Section and the Musical Section.

Shutdown Sequences in Shows

The Light-O-Rama [Show Editor](#) can be used to build [shows](#) with several different sections. Among

these is the [Shutdown Section](#). When the [scheduled](#) end time for the show is reached, the main portion of the show (the [Animation Section](#) and the [Musical Section](#)) stops, and the [sequences](#) in the Shutdown Section are then played, one at a time, in order. After they have all finished, the show is truly finished.

However, this section is fully supported only with the Standard and Advanced license levels.

Using the Basic and Basic Plus license levels, you will still be able to use this section in the Show Editor in a sort of "demo mode", to see what it is like. However, the Light-O-Rama [Show Player](#) will not actually play the sequences in a show's Shutdown section; instead, when the scheduled end time for the show is reached, the Animation Section and the Musical section will stop, and the show will be over.

Background Sequences in Shows

The Light-O-Rama [Show Editor](#) can be used to build [shows](#) with several different sections. Among these is the [Background Section](#). All [sequences](#) in the Background Section will play simultaneously, looping back to their starts when they reach their ends, throughout the entire course of the show.

However, this section is fully supported only with the Standard and Advanced license levels.

Using the Basic and Basic Plus license levels, you will still be able to use this section in the Show Editor in a sort of "demo mode", to see what it is like. However, the Light-O-Rama [Show Player](#) will not actually play the sequences in a show's Background Section.

Sequence in Sequence

[Sequences](#) can themselves contain [subsequences](#) - a parent sequence containing a child sequence. The parent sequence can be set to start or stop the child sequence at any given point during play.

However, subsequences are only fully supported with the Advanced license level.

Using other license levels, you will still be able to use subsequences in a sort of "demo mode", to see what they are like, but you will not be able to save changes to your sequence after having done so.

MIDI Wizard

The [MIDI Wizard](#) can be used to automatically insert [timings](#) and [lighting effects](#) into a [musical sequence](#) that is based upon a MIDI song. For example, it can make your lights chase each other in time to the music, or turn certain channels on or off based upon what notes are being played.

However, the MIDI Wizard is fully supported only with the Advanced license level.

Using other license levels, you will still be able to use the MIDI Wizard in a sort of "demo mode", to see what it is like, but you will not be able to save changes to your sequence after having done so.

Execute Windows Shell Commands

Using the Advanced license level, Light-O-Rama can optionally [tell Windows to execute any arbitrary command](#) that you specify when a particular [sequence](#) is started. An example of how this might be used: If you broadcast the songs playing during your [show](#) over the radio, you might set your sequences up so that they tell Windows to tell your RDS ("Radio Data System") program to also broadcast the name of the song, allowing people with RDS-enabled radios to see the name of the song currently playing in your show.

Triggered Interactive Sequences

In addition to being able to [control lights](#), some [Light-O-Rama controllers](#) can also accept input, acting as [triggers](#) to start particular [sequences](#) on demand during a show. For example, as part of your display, you could have several buttons for people to push, each of which will play a particular song.

However, this feature is fully supported only with the Advanced license level.

Using other license levels, you will still be able to use this section in the [Show Editor](#) in a sort of "demo mode", to see what it is like. However, the Light-O-Rama [Show Player](#) will not actually play any sequences which are triggered during your [show](#).

Show Startup Options

Normally, the [sequences](#) in a [show](#) will start playing immediately at the show's [scheduled](#) start time. The Advanced license level allows more control over this; for example, you could hook a big red button labeled "Start the Show" up to one of your [Light-O-Rama controllers](#), and the show will not start until that button is pushed.

For details, please see "[Show Startup Options](#)".

Full Screen Video Playback

When a [musical sequence](#) is based upon a video file (such as a WMV file), the Advanced license level can show the video in full screen mode (and similarly, it can show full screen audio visualizations for musical sequences based upon audio files).

Lower license levels cannot show full screen video (or full screen audio visualizations), but they may still be able to show video and visualizations in a window instead of in full screen. See [Video Playback \(Windowed Mode\)](#) for details.

Multiple Networks

The [Light-O-Rama Software Package](#) can send [lighting commands](#) to [Light-O-Rama controllers](#) over several different [Comm ports](#) simultaneously. This has several potential uses, especially for people with large numbers of controllers, or lights spread out physically far from each other.

However, this is supported only in the Advanced license level. Other license levels will send lighting commands to Light-O-Rama controllers only over a single Comm port.

Create Protected Sequences

The Light-O-Rama [Sequence Editor](#) can be used to create [protected sequences](#), which are

[sequences](#) which cannot be modified (generally speaking) or viewed in the Sequence Editor, but which can still be played, control lights, [scheduled](#) in [shows](#), and so forth.

However, this is supported only in the Advanced license level. Other license levels can use protected sequences, but cannot create them.

DMX Intensity

Light-O-Rama allows the possible intensity of most [lighting effects](#) ranges from 0 to 100, i.e. a percentage of full intensity. DMX devices, however, are capable of taking 256 different intensities (from 0 to 255), rather than 101. Light-O-Rama supports this possibility via the [DMX Intensity tool](#).

However, this is only supported in the Advanced license level. Other license levels will not have access to the DMX Intensity tool.

Native DMX Devices Supported

The Advanced license level can send lighting commands to [DMX devices](#), in addition to [Light-O-Rama controllers](#). Lower license levels can only send lighting commands to Light-O-Rama controllers.

Dasher Controllers Supported

The Advanced license level can send [lighting commands](#) to [Dasher controllers](#), in addition to [Light-O-Rama controllers](#). Lower license levels can only send lighting commands to Light-O-Rama controllers.

X10 Controllers Supported

The Advanced license level can send [lighting commands](#) to [X10 controllers](#), in addition to [Light-O-Rama controllers](#). Lower license levels can only send lighting commands to Light-O-Rama controllers.

Digital IO Cards Supported

The Advanced license level can send [lighting commands](#) to [digital IO cards](#), in addition to [Light-O-Rama controllers](#). Lower license levels can only send lighting commands to Light-O-Rama controllers.

BSOFT Digital IO Cards Supported

The Advanced license level can send [lighting commands](#) to [BSOFT digital IO cards](#), in addition to [Light-O-Rama controllers](#). Lower license levels can only send lighting commands to Light-O-Rama controllers.

4 Light-O-Rama Concepts

Light-O-Rama allows your computer to control your lights and other equipment in synchronized displays. Such a display is organized in a few levels:

At the lowest level, a [sequence](#) contains commands to be sent to your Light-O-Rama [hardware](#), which will actually control your lights. For example, a sequence might contain a command to turn on one string of lights while making another string twinkle, and two seconds later, fading the first string down while fading the second string up. A sequence can contain commands for many circuits.

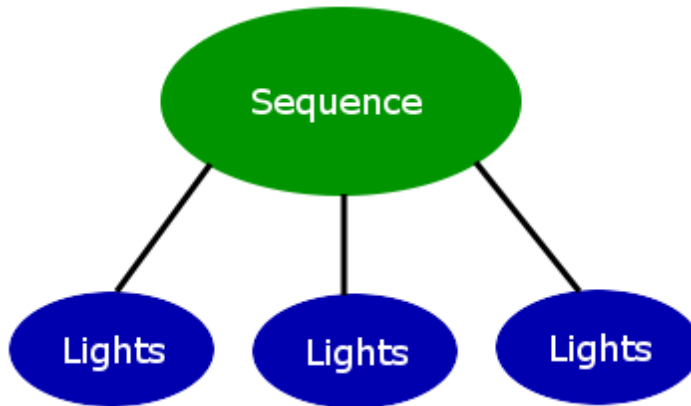

A sequence contains commands for individual strings of lights

Typically, people build a sequence per song that they want in their display (known as [musical sequences](#)), each one containing all of the lighting commands for its particular song. People also build [animation sequences](#), not associated with any particular song, and often build one for each independent part of their display - for example, one animation sequence to control a group of snowmen having a snowball fight, and another to control a tin soldier firing a cannon.

Sequences can be grouped together into [shows](#). A show allows several sequences to be played at the same time, or sequentially, or in random order. A show can contain different sections - for example, some sequences might be played only at the beginning of a show, others only at the end, others in between, and still others for the entire duration of the show.

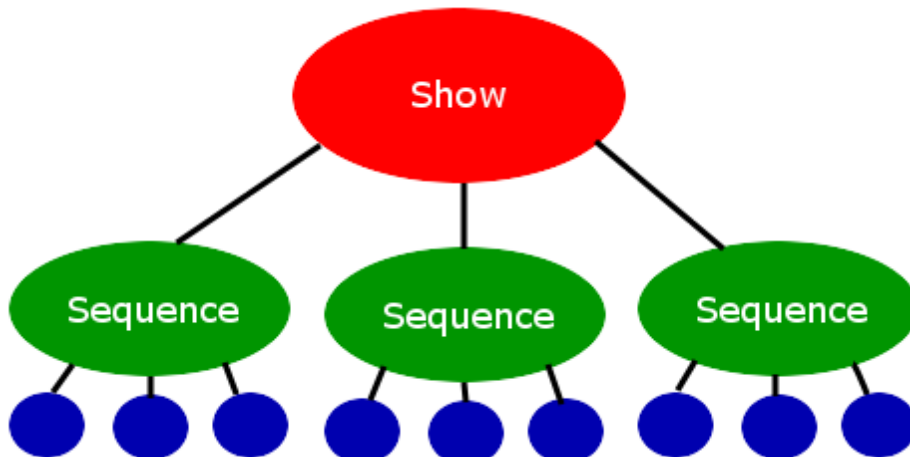

A show contains sequences to be played together, or in order, or randomly

Finally, shows can be [scheduled](#) to be played at certain times. Only one show (at most) can be playing at any given time, but any number of shows can be scheduled for different times, and the same show can be scheduled to play at many different times.

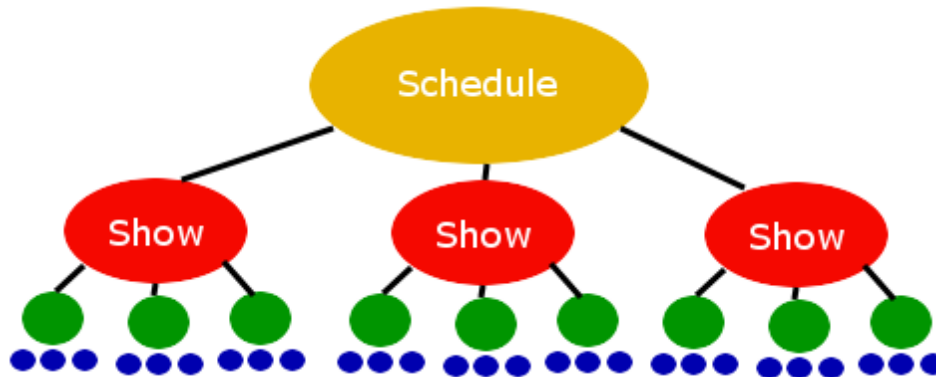

A schedule is used to play shows at specific times

4.1 Sequences

A sequence is a set of commands to be sent to lights - for example, a sequence may command the lights to [turn on](#) when the sequence starts, [turn off](#) a second later, stay off for a tenth of a second, start [twinkling](#) for the next two seconds, and then [fade up](#), from completely off to completely on, during the next three seconds.

A sequence can control multiple sets of lights independently of each other. Each set of lights should be hooked up to a particular circuit on a particular controller; each such circuit is referred to as a "[channel](#)". Additionally, for RGB devices, capable of changing color, three independent channels (a red, a green and a blue) can be grouped together into a single [RGB channel](#).

There are two types of sequences: [animation sequences](#) and [musical sequences](#). Musical sequences are associated with songs (or sound effects, videos, et cetera); the lights can be made to turn off and on (and do other [effects](#)) in sync with the music. Animation sequences are not associated with songs. Many sequences can be played simultaneously, but at most one musical sequence can be playing at a time - all others must be animation sequences. This means that you can control some of your lights in sync to a song via a musical sequence, while simultaneously controlling other lights independently, via animation sequences.

The Light-O-Rama [Sequence Editor](#) is used to create and modify sequences. After creating sequences with the Sequence Editor, you can package sequences together into a [show](#), using the [Show Editor](#), and then [schedule](#) shows to be played at certain times using the [Schedule Editor](#). The [Show Player](#) (if enabled, via the "[Enable Schedule](#)" on the Light-O-Rama [Control Panel](#)) will monitor your schedule and play your shows at the appropriate times.

For example, here is a simple sequence, containing six channels, as represented in the Sequence Editor. As time passes (from left to right), you can see that the first channel is turned on, then it is turned off and the second channel is turned on, then *that* is turned off and the third channel is turned on, and so forth, through the six channels:

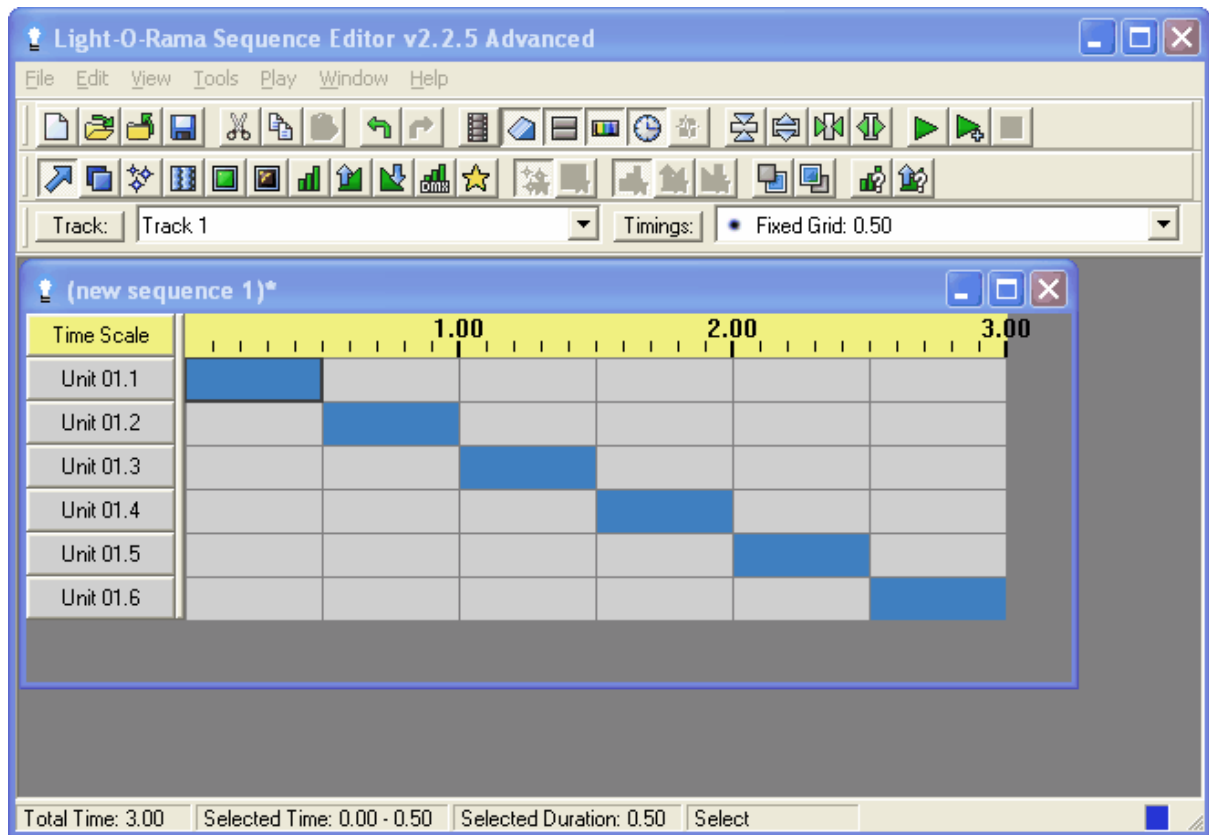

A simple sequence, with lights turning on and off, chasing through six channels

The vertical lines in the grid, representing distinct points in time, are known as [timings](#). These timings do not have any direct effect on how your lights will look; instead, they allow you to select time ranges for lighting [effects](#) to happen, using various tools in the Sequence Editor.

Timings are grouped together into [timing grids](#). A sequence can have more than one timing grid; which one is currently displayed can be controlled via the "Timings" dropdown box in the [Tracks and Timings toolbar](#). For example, the timing grid currently displayed in the sequence shown above has a timing every half a second, and is shown in the dropdown box as "Fixed Grid: 0.50". "Fixed Grid" in this means that the timings are all a certain length of time apart, and that they cannot be moved, deleted, or added to; "0.50" is that length of time (in this case, half a second).

In addition to "fixed" timing grids, a sequence can also have "[freeform](#)" timing grids. In a freeform timing grid, timings can be at any location, and can be moved, added, and deleted. For example, here is the same sequence, but now with a freeform timing grid displayed:

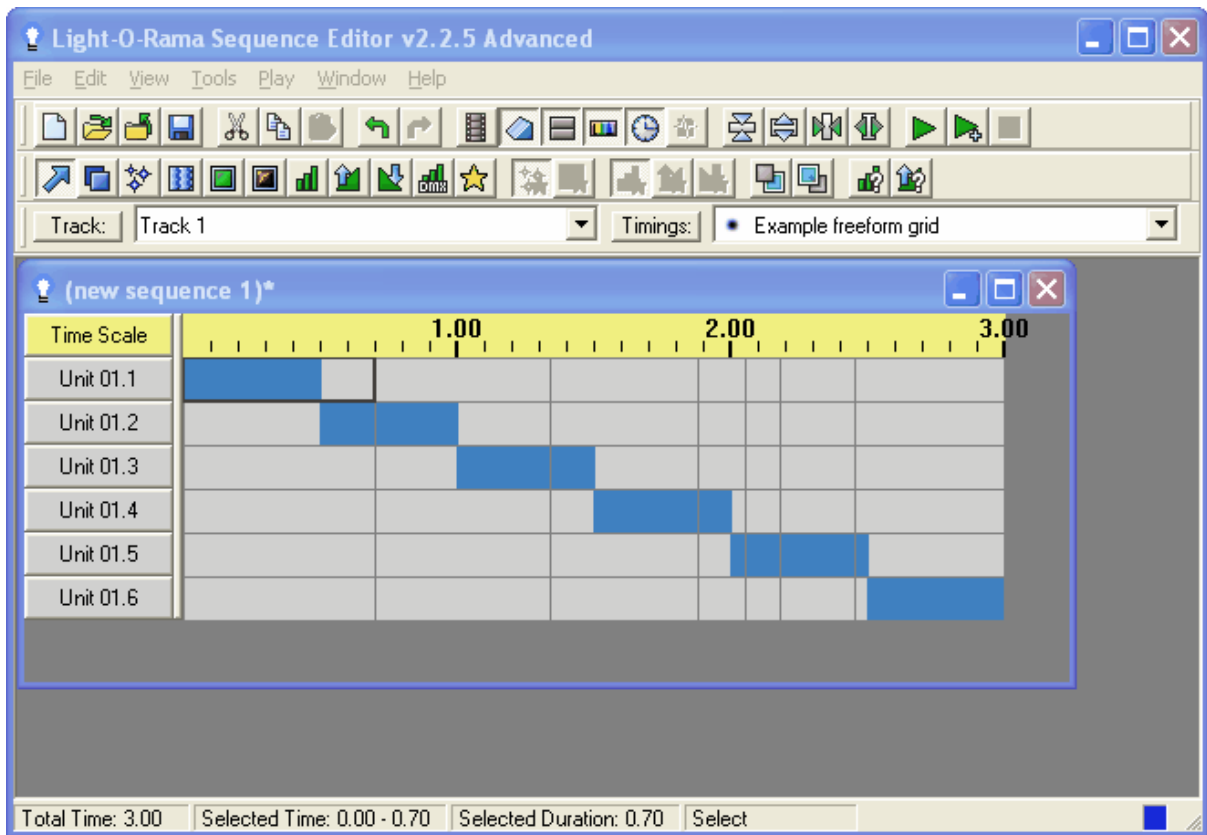

The same sequence, with a freeform timing grid

Note that the timings in this freeform grid are not the same distance from each other. Also note that the timings and the effects do not line up with each other - there is no reason that they would have to. This is so as to allow flexibility in where effects can be applied, without cluttering the display with many timings.

For example, perhaps you might want a sequence to have some effects that are following the drumming in a song, and other effects that are following the lead guitar. You could simply add timings representing both the drumming and the guitar to a single timing grid, but if you do, it could be difficult to remember which timing is for which instrument; also, the display might become cluttered with so many timings. So, instead, you could put the timings for the drums into one timing grid, and the timings for the guitar in another timing grid, and use the dropdown box to easily switch between the two timing grids as appropriate. The effects that you add using the timing grid for the drums will not necessarily line up with the timing grid for the guitar, nor the effects added using the timing grid for the guitar with the timing grid for the drums, but neither should they.

A sequence can contain multiple [tracks](#). A track is a group of [channels](#). Each track can have its own channels, or can share channels with other tracks, or both. Each track can be switched to display any particular timing grid at any time, independently of every other track.

Animation sequences (but not musical sequences) can be set up to use [loops](#). When playing a sequence that contains a loop, when the end of the loop is reached, the sequence will jump back to the beginning of the loop. It will do this a certain number of times (that you specify), and then will continue past the end of the loop. Each time that it jumps back, you can make it go through the loop faster, slower, or the same speed as before. There can be many loops in a sequence (set up for different time ranges), and loops can even contain other loops.

Each sequence can have an [animation](#) associated with it. This lets you draw how your lights will be laid out. When you play a sequence in the Sequence Editor and display its animation, the drawing will behave just like your lights will - your drawing will turn on and off, fade up and down, and so forth.

A sequence can also contain another sequence as a [subsequence](#). The subsequence can be turned on or off at different points in the main sequence, and its effects will play only when it is turned on.

For more detailed information on sequences, please refer to the following sections:

- [The Sequence Editor](#)
- [Animation Sequences](#)
- [Musical Sequences](#)
- [Tracks](#)
- [Channels](#)
- [RGB Channels](#)
- [Timings](#)
- [Effects](#)
- [Loops](#)
- [Animations](#)
- [Subsequences](#)
- [Windows Shell Commands](#)

4.1.1 Animation Sequences

An animation sequence is a [sequence](#) that is not associated with a song (or video, or other audio file). This is as opposed to a [musical sequence](#).

There are some other differences between animation sequences and musical sequences:

- Animation sequences can contain [loops](#), which musical sequences cannot;
- [Tracks](#) in an animation sequence can be of different lengths, while tracks in a musical sequence must be the same length;
- Various song-related tools such as the [Beat Wizard](#), [MIDI Wizard](#), [VU Wizard](#) and [Tapper Wizard](#) are only available for musical sequences.
- Generally speaking, only one musical sequence can be played at a time (although there is an exception to this, described in the help page on [musical sequences](#)), whereas many animation sequences can be played simultaneously.

To create an animation sequence in the [Sequence Editor](#), use the [New Animation dialog](#).

The New Animation dialog

4.1.2 Musical Sequences

A musical sequence is a [sequence](#) that is associated with a song (or video, or other audio file), allowing you to synchronize the song with [lighting effects](#). This is as opposed to an [animation sequence](#).

There are some other differences between animation sequences and musical sequences:

- Animation sequences can contain [loops](#), which musical sequences cannot;
- [Tracks](#) in an animation sequence can be of different lengths, while tracks in a musical sequence must be the same length;
- Various song-related tools such as the [Beat Wizard](#), [MIDI Wizard](#), [VU Wizard](#) and [Tapper Wizard](#) are only available for musical sequences.
- Generally speaking, only one musical sequence can be played at a time (although there is an exception to this, noted below), whereas many animation sequences can be played simultaneously.

The exception to the rule that "only one musical sequence can be played at a time" is that musical sequences put into any section of a [show](#) other than the [musical section](#) are, effectively, treated as animation sequences. That is, their associated songs will *not* be played, and more than one of them can be played simultaneously.

To create a new musical sequence in the [Sequence Editor](#), use the [New Musical Sequence dialog](#).

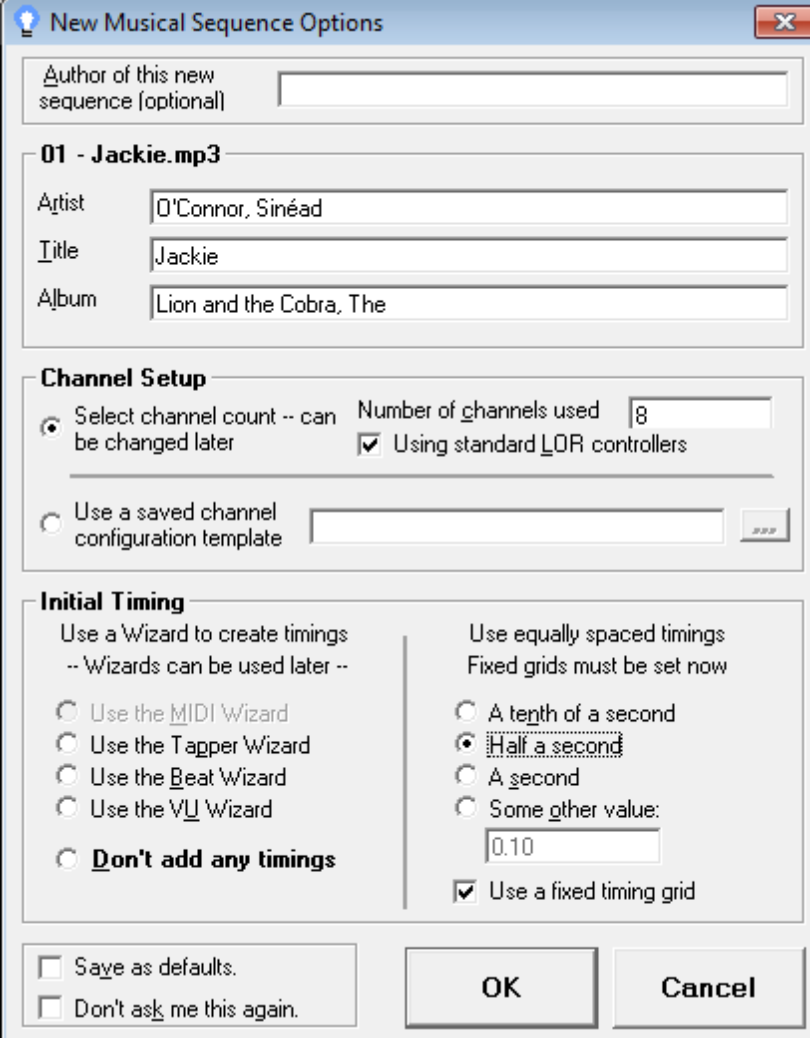

The New Musical Sequence dialog

4.1.3 Channels

A channel is a part of a [sequence](#), representing a particular circuit on a particular [controller](#), which you have lights hooked up to. The [Sequence Editor](#) can be used to assign [effects](#) to channels, to make the lights turn on and off, fade, shimmer, twinkle, and so forth.

Channels have several properties that define exactly which string of lights they relate to:

- Device type, which is the type of [controller](#) (for example, a [Light-O-Rama controller](#) or an [X10 controller](#));
- Network, which is the COM port that this channel's controller is hooked up to the PC over;
- Unit, which is the unit ID of the controller, allowing different controllers to be distinguished from each other;
- Circuit, which represents one particular string of lights hooked up to the controller.

Not all device types have all of these properties - for example, [X10 controllers](#) have a unit ID, but no

circuit number. Please see the help pages on the various types of [controllers](#) for details.

Additionally, there is a "special" device type: a [subsequence](#). A channel set up with this device type does not represent a strand of lights. Instead, it represents another sequence, that the main sequence can turn on and off at different points in time.

Channels also have names and colors associated with them. These have no effect on the way that your lights will look; they only effect how the sequence is displayed in the Sequence Editor. It could be convenient to set them up in meaningful ways. For example, you might want to name the channel associated with a string of red lights running through the bushes in your front yard as "Front Bushes (Red)", and set its color to some shade of red.

In the Sequence Editor, channels are represented as horizontal rows. On the left side of a row is a [channel button](#), labelled with the name of the channel; on the right side is a grid showing what effects are assigned to the channel at what times. For example, the following sequence has six channels, and they are named, simply, "Channel 1" through "Channel 6". One of them ("Channel 4") has an effect: a fade up, from zero seconds to one second:

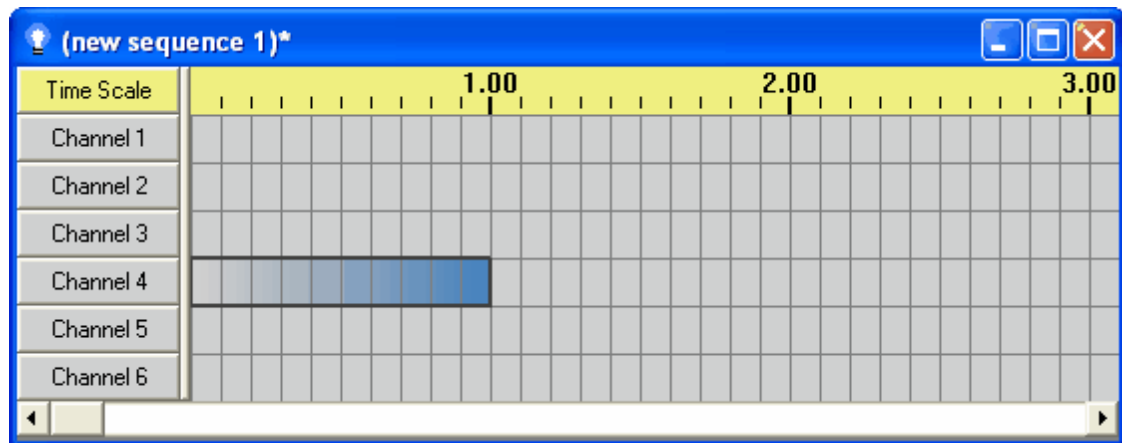

A sequence with six channels - one on each row - and a fade up on the fourth channel

To turn a channel on or off at a certain time, or do other effects such as fades or twinkles, select the [effect](#) that you want, and click on the cell or cells for the times that you want that effect to take place. See [Editing Sequences Using the Keyboard](#) and [Editing Sequences Using the Mouse](#) for more details on this.

Between the channel buttons and the grid is a thick grey vertical bar. You can change the size of the channel buttons by clicking and dragging this bar. Clicking the bar (without dragging) will hide the channel buttons entirely; clicking it again will make them reappear. You can also control whether channel buttons are displayed or hidden from the [View menu](#), and from the [standard toolbar](#), and set your default preference in the [Display Preferences menu](#).

Clicking on a channel's button brings up the [Channel Settings](#) dialog. This allows control over various things like the channel's name, color, unit, and circuit:

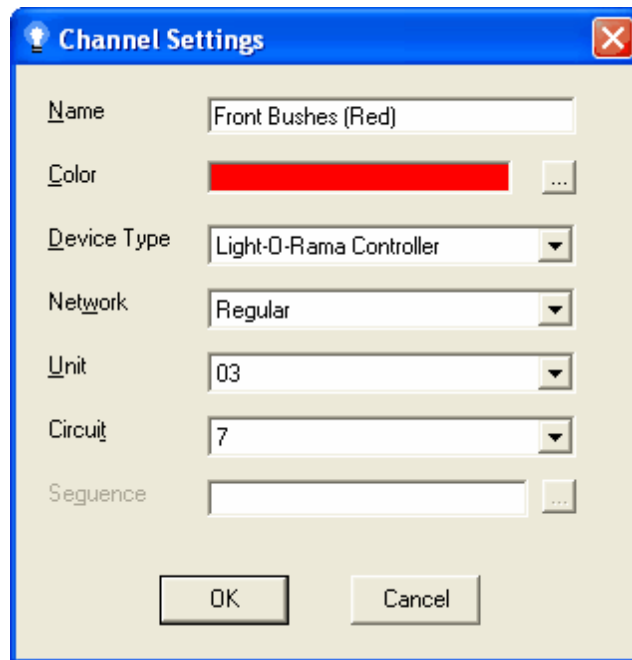

The Channel Settings dialog

Right-clicking on a channel's button brings up a [popup menu with various channel-related tools](#):

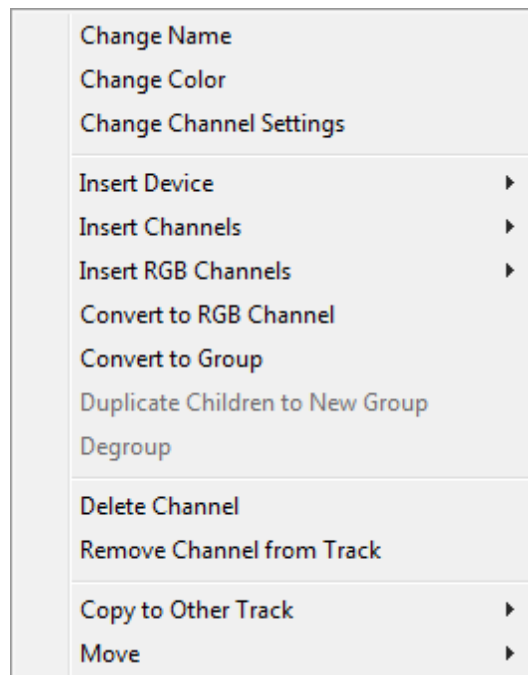

The Channel Button Popup Menu

Channel buttons can be dragged up and down to rearrange their order. This has no effect on your lights; it only affects the order that they are displayed in the Sequence Editor.

When you play a sequence in the Sequence Editor, its channel button flashes with the color that you selected as it turns on and off; it will also fade up and down, shimmer, twinkle, and so forth, just as your

lights will. If you do not wish to see the channel buttons change color during play, you can turn it off temporarily in the [Play menu](#) or the [standard toolbar](#), or set your default preference in the [Display Preferences](#) menu.

The Channel Configuration screen can be used to view and change many channels' settings at once:

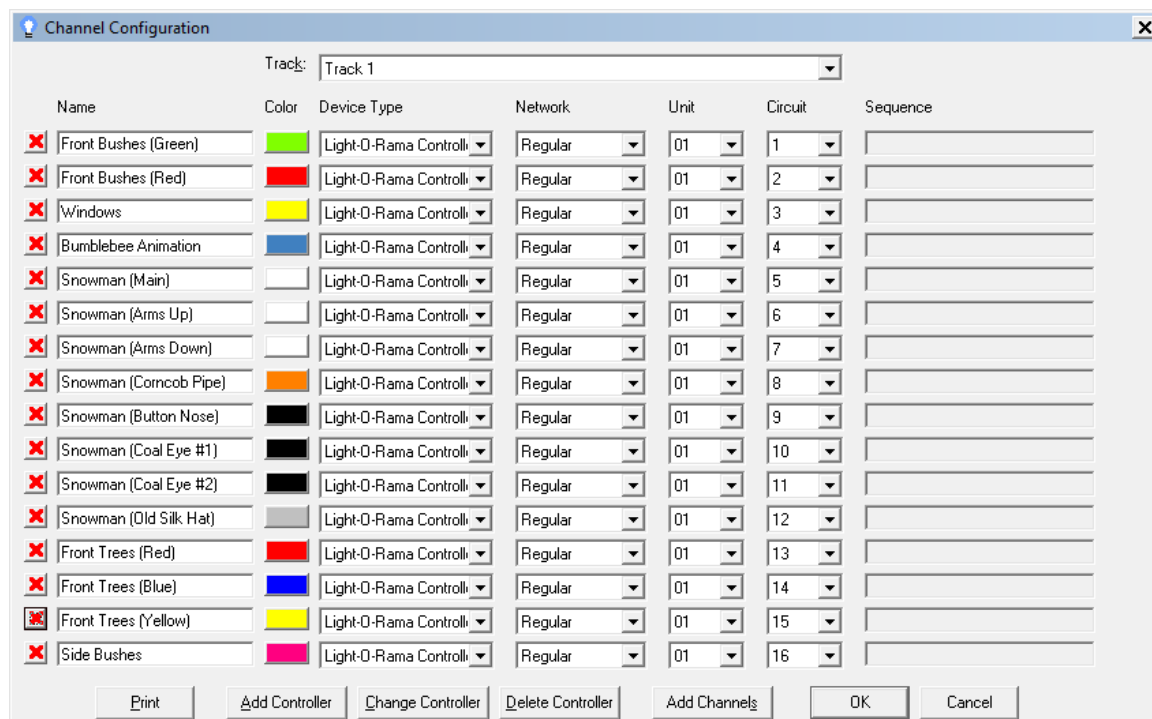

The Channel Configuration screen, showing several channels simultaneously

A channel can be in a single [track](#), or shared among more than one track. By default, there is one track in a sequence, and all channels in the sequence are in that track. To share a channel between tracks, do *not* simply set up two different channels having the same unit number, circuit number, et cetera in the two tracks; this will have unexpected and undesired results, as the two different channels will compete with each other for control of the same circuit. Instead, share a channel by copying it to the other track. There are several ways to do this; see the help page on [tracks](#) for details.

For RGB devices, which can change colors, three separate channels (a red, a green, and a blue) can be grouped together into a single [RGB channel](#).

For more detailed information on how to create and modify channels in the Sequence Editor, please see:

- [Channel Buttons](#)
- [Channel Settings](#)
- [Channel Buttons' Popup Menu](#)
- [The Channel Configuration Screen](#)

4.1.4 RGB Channels

An RGB channel is a group of three [channels](#) - a red channel, a green channel, and a blue channel - representing a single pixel on an RGB device (which can change colors), such as a pixel on a Cosmic Color Ribbon. In the [Sequence Editor](#), an RGB channel is represented by a black row in a [sequence](#) (as opposed to normal channels, which are represented by grey rows). [Lighting effects](#) on an RGB channel

are represented in the row as colors:

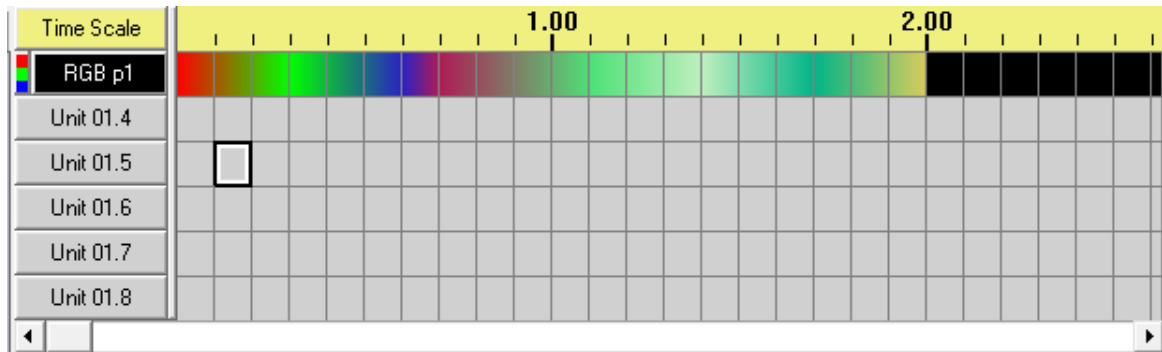

A sequence with an RGB channel followed by several normal channels

To the left of an [RGB channel's button](#) is a small button with red, green, and blue stripes. Clicking on this button will expand the view of the RGB channel so that its constituent red, green, and blue channels can also be seen (and clicking it again will collapse the view to hide those constituent channels):

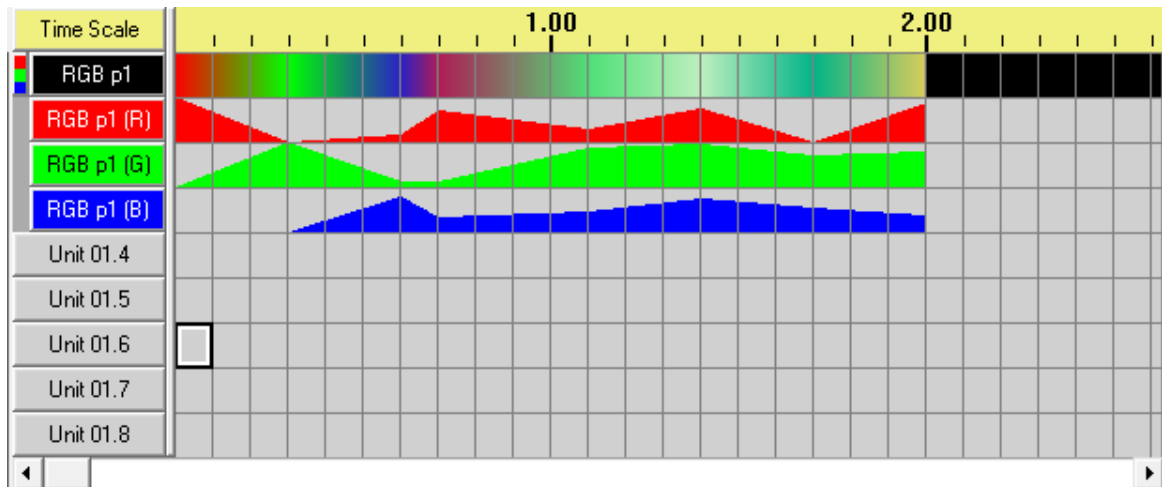

The same sequence, with the view of the RGB channel expanded so that its constituent channels can be seen

The RGB channel's lighting effects can be modified by applying [tools](#) (such as [Shimmer](#) or [Toggle](#) or [Fade Up](#)) to its constituent channels, but they can also be modified directly by using the [Color Fade](#) tool on the RGB channel itself. This tool allows you to specify a start color and an end color; when applied to a time range in the RGB channel, it will cause that time range to gradually fade from the start color to the end color.

An important thing to note here, though, is that the colors displayed on your screen in the Sequence Editor are not necessarily the same colors that will appear on your actual RGB device, and in some cases may actually be very different. Different RGB devices may produce different colors when their constituent R, G, and B channels are sent the exact same intensities. So, you may have to experiment a bit to figure out colors as displayed in the Sequence Editor that wind up looking the way you want on your actual RGB devices.

Another tool which may be particularly useful for RGB channels is the [Fill](#) tool, which (on a normal channel) allows you to click an empty area and cause it to become a fade from the preceding intensity to the following intensity. For example, if you have a normal channel which has a fade up from 40 to 60,

followed by the lights being off, followed by a fade down from 80 to 20, then applying the Fill tool to the area where the lights are off will cause that area to become a fade up from 60 to 80 (because the effect preceding the empty area ended at intensity 60, and the effect following the empty area started at 80). On an RGB channel, the Fill tool will instead cause a color fade from the preceding color to the following color, hopefully allowing you to quickly set up smooth color transitions across several different colors.

The [Chase](#) and [Repeat](#) tools may also be of particular use on RGB channels. The Chase tool causes the lighting effects in a single channel (or RGB channel) to be applied through a range of following channels (or RGB channels), offset in time a bit with each passing row, so that the effect seems to be "chasing" through the channels (or RGB channels) as time passes. The Repeat tool causes one or more copies of the lighting effects in your selection to be applied immediately following your selection.

Other tools, such as [Shimmer](#) or [Toggle](#) or [Fade Up](#), can also be applied to RGB channels. Doing so will cause the tool to be applied to each of the RGB channel's constituent channels. For example, applying the Fade Up tool, with intensities 0 to 100, to an RGB channel will cause each of the red, green, and blue channels to fade up from 0 to 100, thus making the RGB channel itself fade from black to white.

Such tools can also be directly applied to the constituent channels of an RGB channel (as opposed to the RGB channel itself), allowing for finer grained control over the behaviour of the RGB channel.

Clicking on an [RGB channel's button](#) will open the [RGB Channel Settings dialog](#), allowing control over various settings such as the [units](#) and [circuits](#) of the constituent channels:

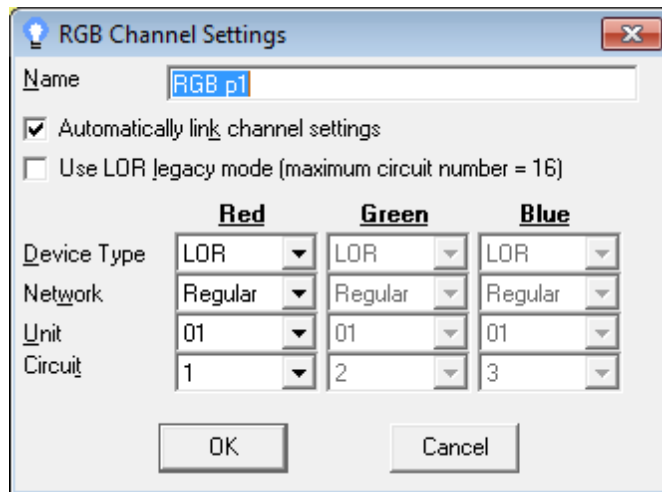

The RGB Channel Settings dialog

Right-clicking on an RGB channel's button will open up a [popup menu](#) with various channel and RGB channel-related tools:

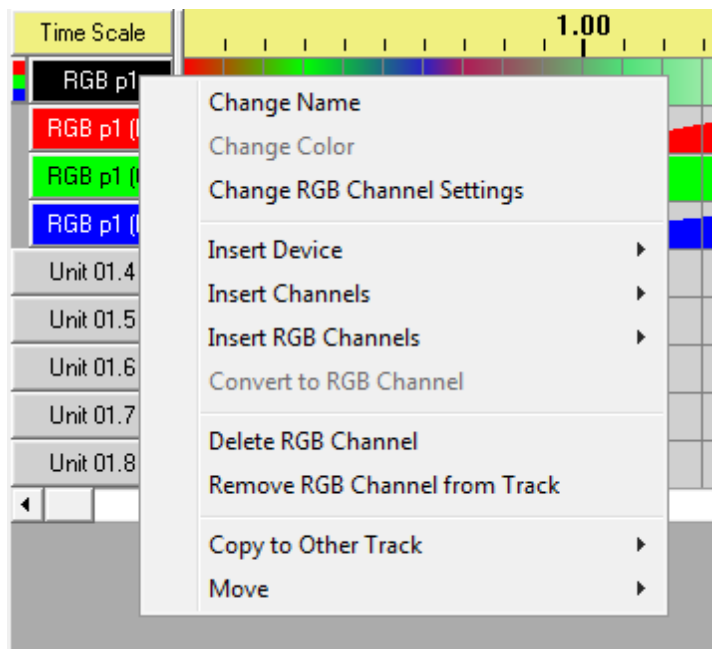

The RGB Channel Button Popup Menu

RGB channels can be added to a sequence in a few ways, all via the Channel/RGB Channel Button Popup Menu. First, the "[Insert Device](#)" menu item has options to insert a [Cosmic Color Device](#) or a [generic RGB device](#), both of which will result in RGB channels being added to the sequence. Second, the "[Insert RGB Channels](#)" menu item will create new RGB channels. Third, existing regular channels can be converted to RGB channels via the "[Convert to RGB Channel](#)" menu item.

4.1.5 Channel Groups

A channel group is a set of [channels](#) or [RGB channels](#) (or, conceivably, other channel groups) that is nested together, so that it can be collapsed down to a single row in the [sequence's](#) display, or expanded to show all of its members, or (in some cases) partially expanded to show some of its members. When a channel group is first created (or when a sequence with one is first opened or created), the channel group is shown as a single row:

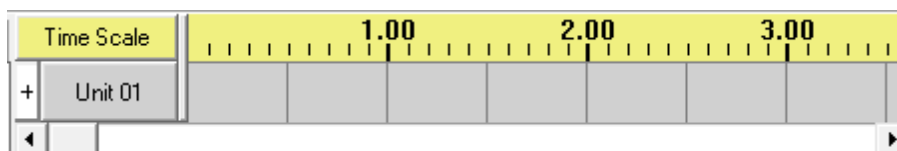

An unexpanded channel group

To the left of the channel group's row is a small white button with a "+" sign. Left-clicking on this expands the channel group to show all of its rows (and the "+" sign changes to a "-" sign):

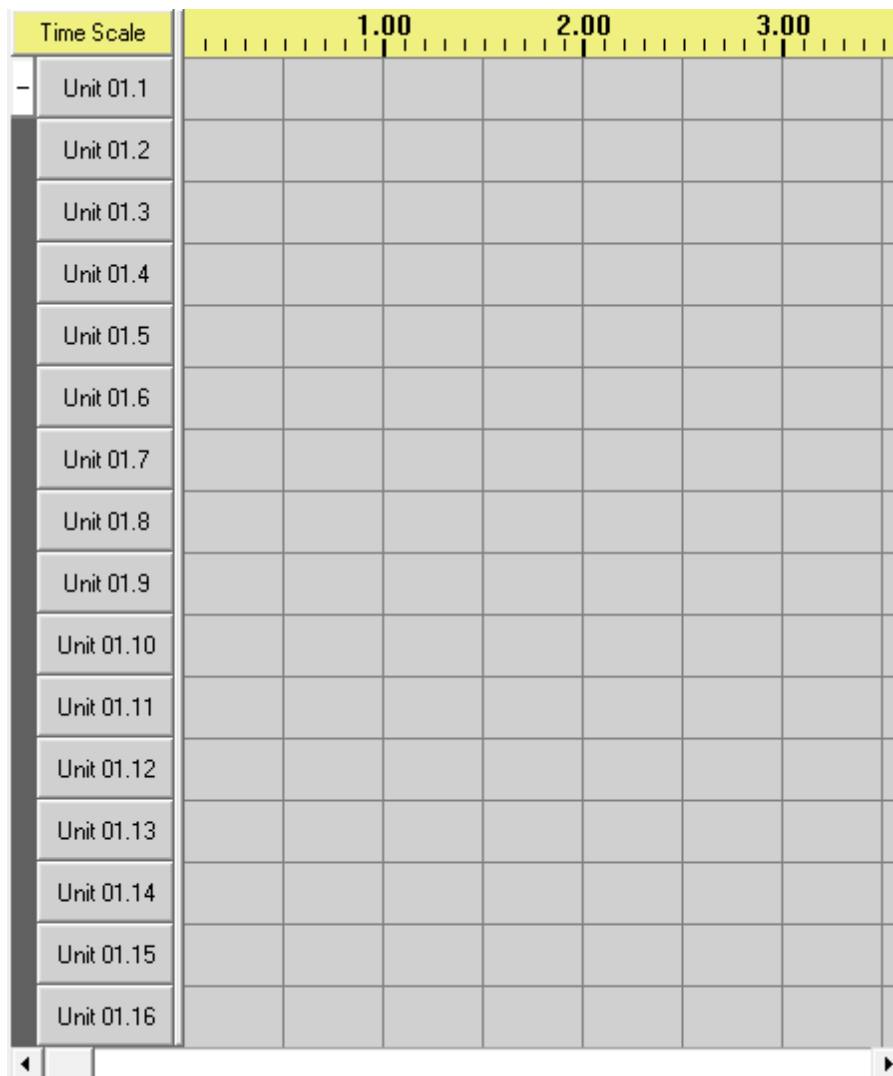

The same channel group, fully expanded

Clicking the small white button again collapses the channel group back to a single row:

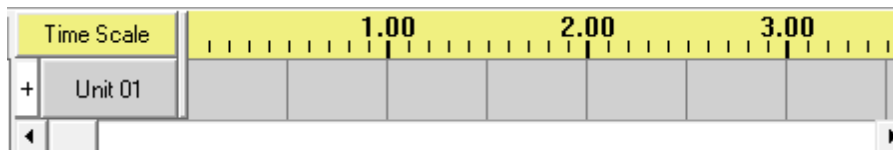

The same channel group, collapsed again.

If you hold the Shift key while clicking, not only the channel group, but also all of its descendants (with the exception of RGB channel descendants) will be expanded if it is collapsed, and all of its descendants collapsed if it is expanded. Holding both the Ctrl and Shift keys will cause all of its descendants (including RGB channels) to be expanded if it is collapsed, and all of its descendants to be collapsed if it is expanded.

Depending upon how many channels are in the channel group, right-clicking on the small white button may partially expand the channel group, showing the first and last channels, plus some approximately equally spaced channels in between:

Time Scale		1.00				2.00				3.00			
=	Unit 01.1												
	Unit 01.6												
	Unit 01.11												
	Unit 01.16												

The same channel group, partially expanded.

Right-clicking on the small white button again may partially expand it further, showing more channels:

Time Scale		1.00				2.00				3.00			
=	Unit 01.1												
	Unit 01.3												
	Unit 01.5												
	Unit 01.7												
	Unit 01.10												
	Unit 01.12												
	Unit 01.14												
	Unit 01.16												

The same channel group, partially expanded further

If you keep right-clicking, eventually the channel group will be fully expanded, after which another right-click will collapse it back to a single row. Exactly how many right-clicks it takes to go from collapsed to fully expanded depends upon the number of channels in the channel group.

When a channel group is collapsed, the [effects](#) displayed on its row are the events of its first channel (or RGB channel). However, applying a [tool](#) to the row actually applies it to all of its members. For example, with the channel group compressed, if you apply the [Fade Up tool](#) to its first cell, the result will look like this:

Time Scale		1.00				2.00				3.00			
+	Unit 01												

The same channel group, collapsed, after applying the Fade Up tool while it was collapsed

But when you expand the channel group, it becomes apparent that the Fade Up tool was applied to all of the channel group's members:

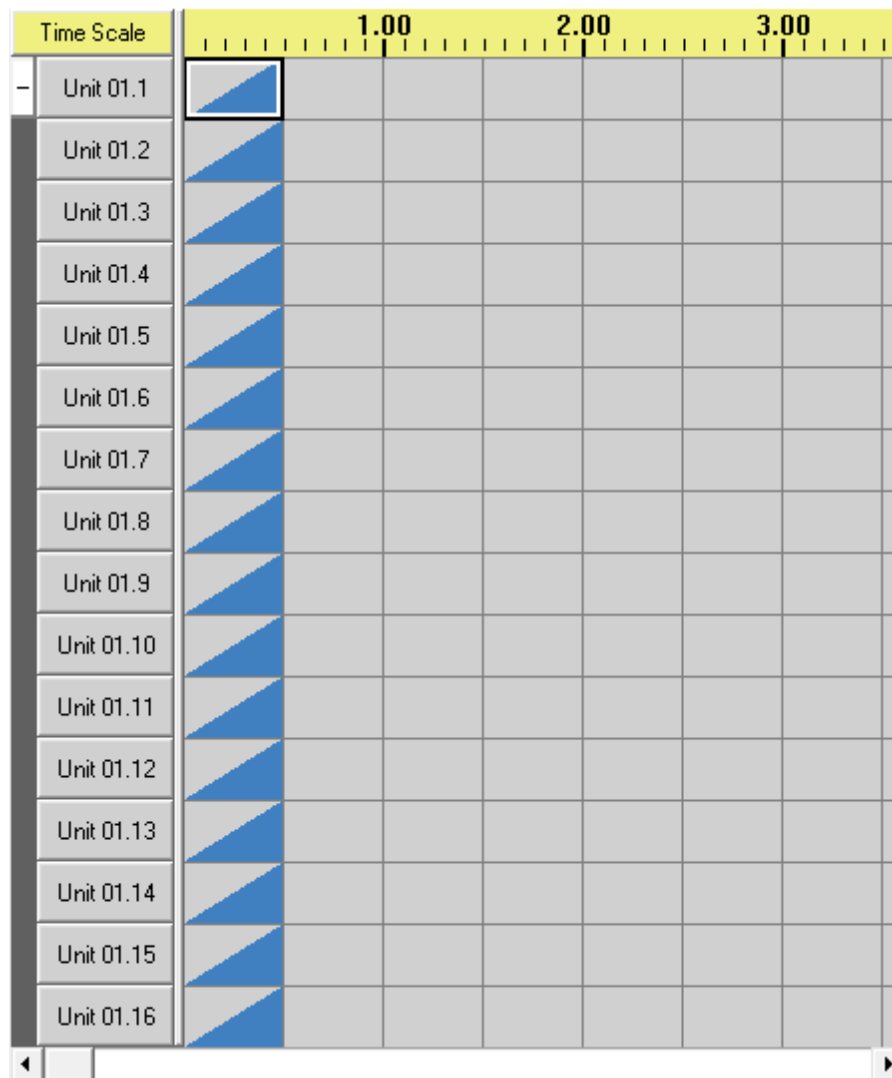

The same channel group, expanded

If you then collapse the channel group, and apply the [Chase tool](#) to it while it is collapsed, no change will be evident from what is displayed:

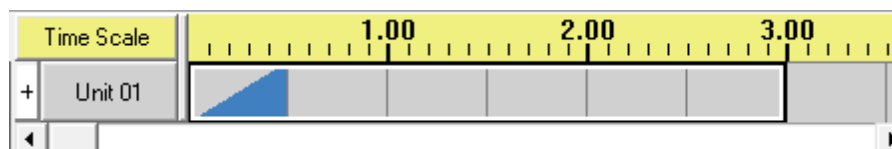

After applying the Chase tool, while collapsed

But a change did happen - the Chase tool was applied to the entire channel group. The only reason that no change is evident from what is displayed is because when the channel group is collapsed, only the effects of the first channel are displayed, and the Chase tool did not alter the effects of the first channel. Expanding the channel group reveals the change:

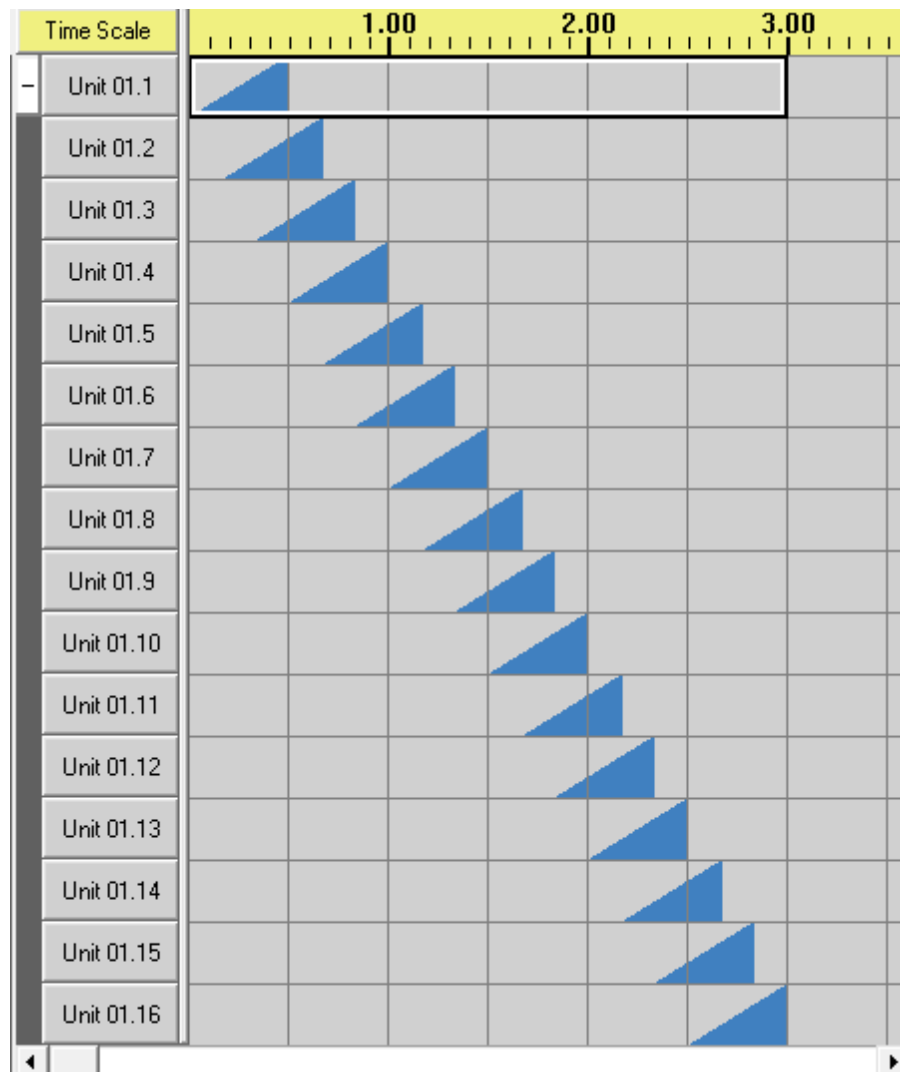

Expanded, after a chase

If the channel group is then partially expanded, the chase can be partially seen:

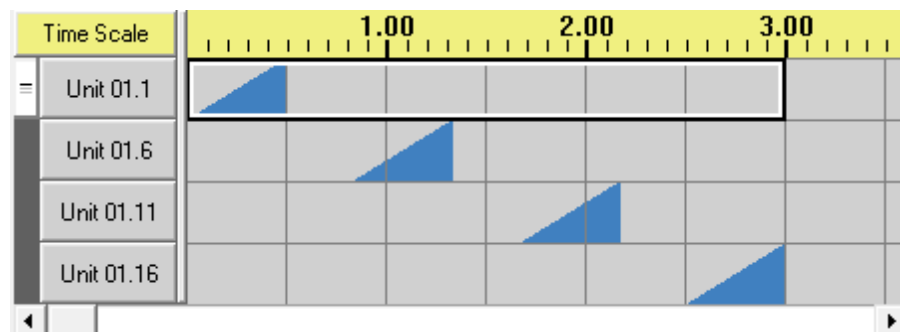

Partially expanded, after a chase

While it is partially expanded, applying a tool to a single row will apply that tool only to that channel. For example, if the [Shimmer tool](#) is applied to the row for "Unit 01.6", the result will look like this:

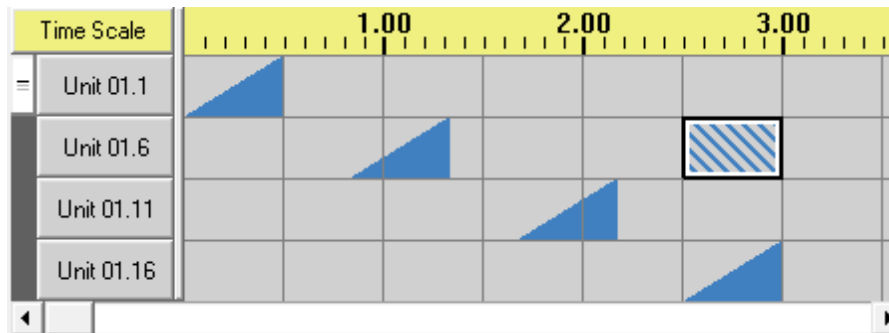

After a shimmer is applied to a single row while partially expanded

Expanding the channel group reveals that the shimmer really was applied only to that channel:

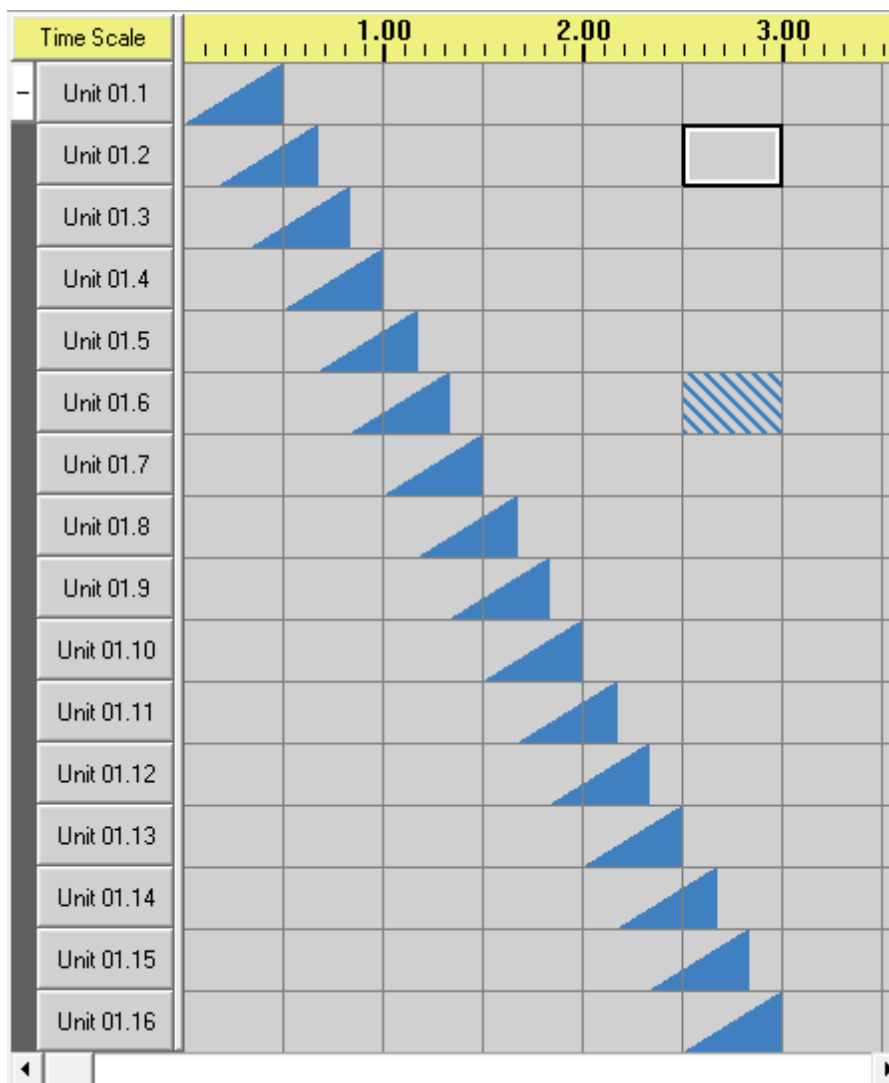

Fully expanded, after a single row shimmer

But if a tool is applied to more than one row while partially expanded, it is actually applied to all channels from the first selected row to the last, regardless of whether they are explicitly displayed or not. For example, if (while partially expanded) the [Twinkle tool](#) is applied to "Unit 01.6" and "Unit 01.11",

the result will look like this:

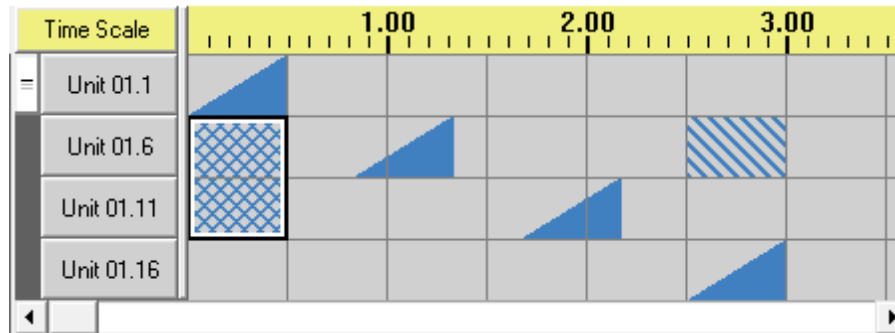

Partially expanded, after a twinkle is applied to multiple rows

But expanding the channel group reveals that the twinkle was applied not just to Unit 01.6 and Unit 01.11, but also to all channels in between them:

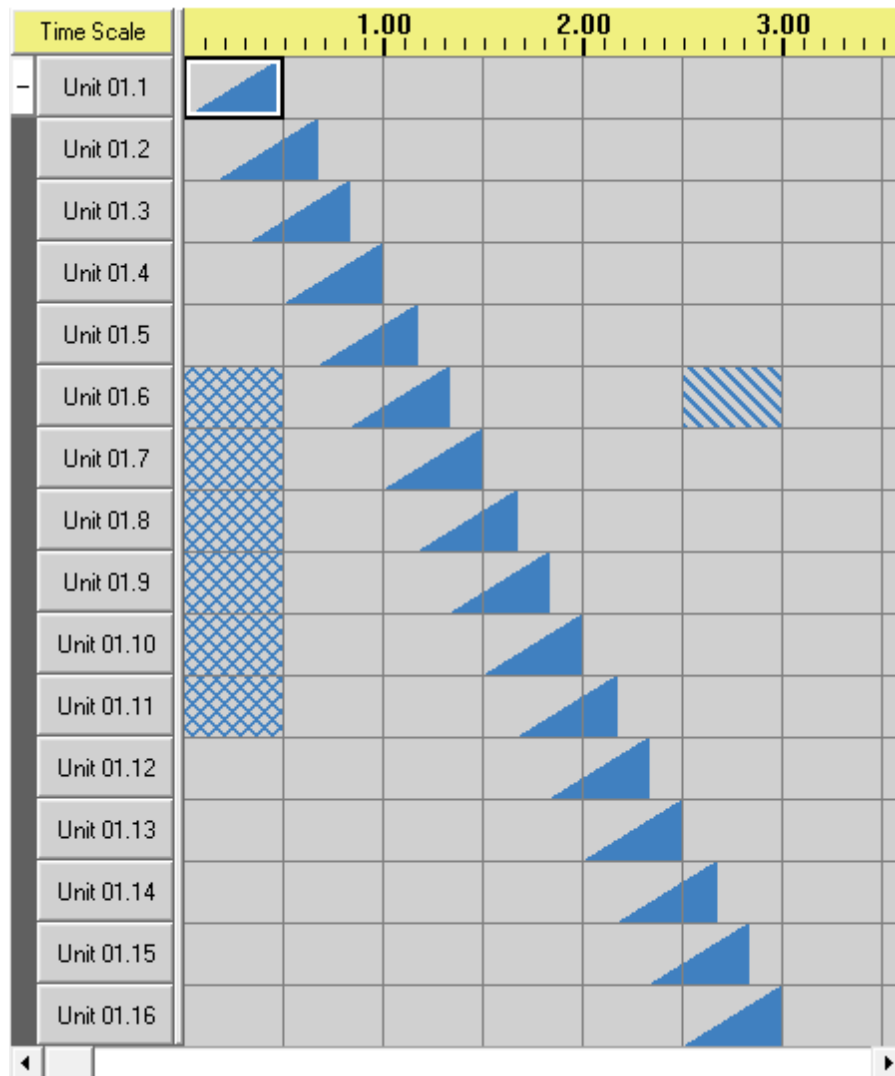

Expanded, after a twinkle was applied to multiple rows while partially expanded

Channel groups can be created via the [Insert Device dialog](#). If the "Add as a Group" checkbox on that dialog is checked, the device will be added as a channel group; if it is unchecked, the device will be created as raw channels and/or RGB channels.

You can also convert existing channels (and RGB channels, etc.) so that they become part of a new channel group, by using "[Convert to Group](#)" on a [channel button's right-click popup menu](#). You can "degrouper" a group -- that is, move its children to its parent, and then remove it itself from its parent -- by using "[Degrouper](#)" on that same popup menu.

When a [Cosmic Color Device](#) is created as a group, and it contains macro channels, it is treated a little differently than other channel groups. First, those macro channels will only be displayed when the channel group is fully expanded, and never when it is only partially expanded. Instead, when it is partially expanded, the last displayed row will be the last RGB channel. Second, if a tool is applied to the group while collapsed, it is only applied to the group's RGB channels, not to its macro channels.

4.1.6 Timings

Timings are the times in a [sequence](#) at which you can command the lights to do various [effects](#) - to turn on, turn off, fade up, fade down, and so forth.

Timings are represented in the [Sequence Editor](#) by vertical grey lines. For example, the following sequence has timings every half a second, at 0.5 seconds, 1 second, 1.5, 2, 2.5, 3, and so forth:

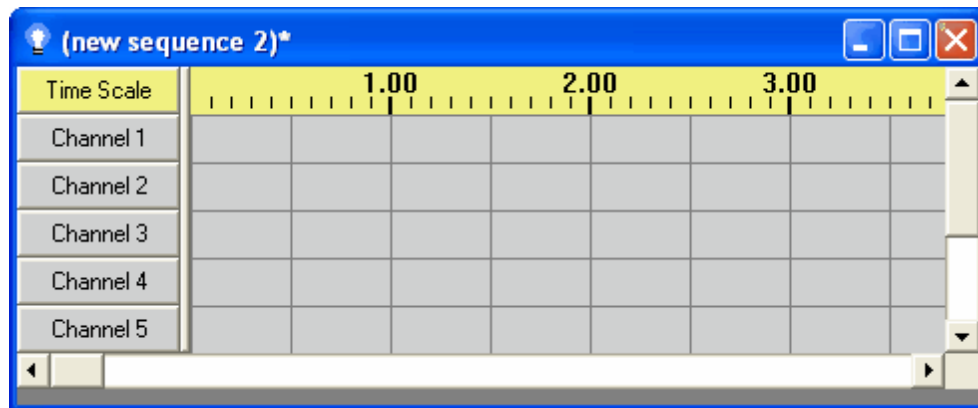

A sequence with timings every half a second

Timings do not have any direct effect themselves on the behavior of your lights; rather, they simply give you a way to specify a start time and an end time for [effects](#) on a [channel](#). The space between two timings can be set to an effect by selecting the appropriate tool (such as the "[Fade Up](#)" tool) and clicking on the space (please see "[Editing Sequences Using the Keyboard](#)" and "[Editing Sequences Using the Mouse](#)" for details). For example, selecting the "[On](#)" tool and clicking the cell between 1 second and 1.5 seconds for Channel 2 results in:

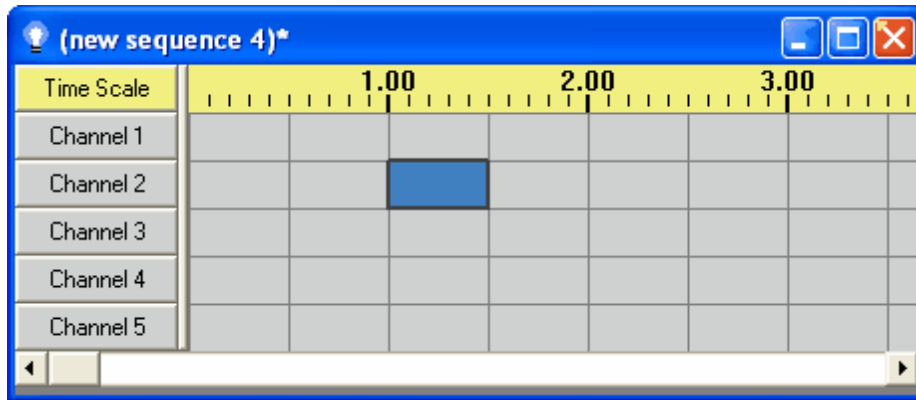

The second channel has been turned on, between 1 second and 1.5 seconds

Timings do not have to be equally spaced (as they are in the above example). For example, the following sequence has timings at 0.37 seconds, 1 second, and 3.2 seconds:

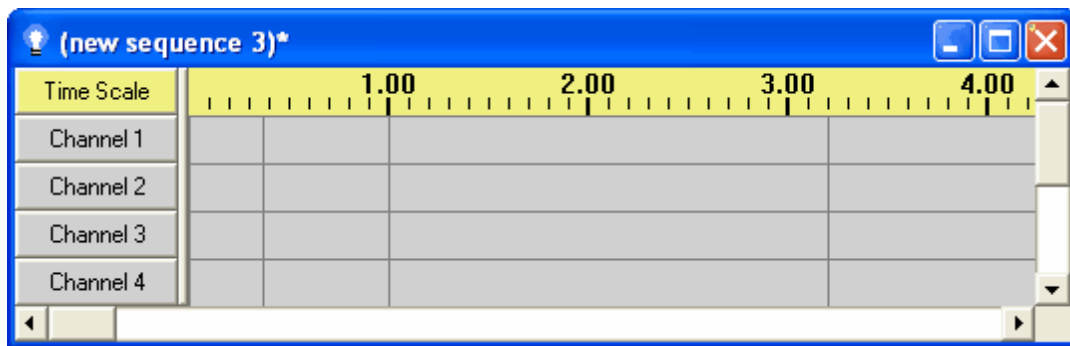

A sequence with timings at 0.37 seconds, 1 second, and 3.2 seconds

Timing Grids

A set of timings is known as a "timing grid". A sequence can have more than one timing grid, with one being shown at a time (or, if the sequence has more than one [track](#), one per track at a time). The timing grid that is currently shown can be changed by selecting from the "Timings" dropdown box on the Tracks and Timings Toolbar. There are two types of timing grids: [fixed grids](#) and [freeform grids](#).

Fixed Timing Grids

In a fixed timing grid, each timing is the same length of time from the next timing. For example, a fixed timing grid might have a timing every second, or every tenth of a second.

The timings in a fixed timing grid cannot be moved, deleted, or added to.

Freeform Timing Grids

In a freeform timing grid, timings do not have to be equidistant. For example, a freeform timing grid might have one timing at time 1.00 (i.e. one second), another half a second later at time 1.50, and another 2.2 seconds past that at time 3.70.

The timings in a freeform grid can be moved or deleted, and new timings can be added.

Creating, Deleting, and Modifying Timings

Timings can be automatically inserted into a sequence when it is created, in a variety of ways. For example, you can tell the Sequence Editor to insert timings every so often - for example every half second, or, for a [musical sequence](#), insert timings based on the song itself using various tools like the [Beat Wizard](#), [VU Wizard](#), [Tapper Wizard](#), and [MIDI Wizard](#). If you tell it to insert timings every so often (such as every half second), it will give you the option to create them in a [fixed timing grid](#) or a [freeform timing grid](#); if you tell it to use one of the tools, or not to insert timings, it will use a freeform timing grid. Please see the [New Animation dialog](#) and [New Musical Sequence dialog](#) for details.

The New Musical Sequence dialog

These tools (such as the Beat Wizard and MIDI Wizard) can also be used after the sequence has been created, by selecting them from the [Tools menu](#).

Timings in a freeform timing grid can be moved by clicking and dragging them. Or, if you wish, this behavior can be turned off by selecting "[Lock Timings](#)" in the [Edit menu](#).

Timings can also be added, deleted, and resized in a variety of other ways:

- On the [Edit menu](#):
 - [Copy and paste timings](#)
 - [Insert multiple timings](#)
 - [Delete extraneous timings](#)
 - [Switch timing grid](#)
- On the [right-click context menu](#):
 - [Copy timing](#)
 - [Paste timing at...](#)
 - [Paste timing at \(centisecond\)](#)
 - [Paste timing multiple](#)
 - [Insert timing at...](#)
 - [Insert timing at \(centisecond\)](#)
 - [Insert multiple timings](#)
 - [Delete timing at...](#)
 - [Delete selected timings](#)
 - [Resize timings to...](#)
 - [Resize timings to equal times](#)
- Using the [Tracks and Timings toolbar](#)

4.1.7 Effects

Light-O-Rama allows you to make your lights behave in a variety of ways. In addition to simply turning them on and off, you can turn them on to varying levels of brightness, have them fade up or down, shimmer, or twinkle.

You can assign these effects to [channels](#) in a [sequence](#) using the [Sequence Editor](#). There are various ways to apply the effects to a sequence; see [Editing Sequences Using the Keyboard](#) and [Editing Sequences Using the Mouse](#) for details. One simple way is to select the effect's tool from the [Tools toolbar](#), and click on a cell or range of cells that you want to apply the effect to.

Most of these effects require that you use [Light-O-Rama controllers](#). Although Light-O-Rama can control other types of devices (such as [X10 controllers](#) or [digital IO cards](#)), only "on" and "off" are supported in these non-LOR controllers.

- [On, Off, and Set Intensity](#)
- [Twinkle](#)
- [Shimmer](#)
- [Fade Up and Fade Down](#)
- [Custom Fade/Intensity Twinkles and Shimmers](#)
- [DMX Intensity](#)

Related to effects are the effect editing modes: [background effects](#), [foreground effects](#), and [regular effects](#). These are not themselves effects, but are ways to use the Sequence Editor to turn effects on based upon the existing effects. For example, with background effects mode on, if some cells are selected and the "twinkle" tool is used, only the selected cells that are currently off will be changed to twinkles. The other cells - those that are on or at some intensity, have fades, shimmers, or twinkles, will remain unchanged.

On, Off, and Set Intensity

The "On" and "Off" effects will turn a string of your lights to their full brightness or completely off, respectively. Additionally, the "Set Intensity" effect allows you to specify a percentage of full brightness - for example, 50% bright.

In the [Sequence Editor](#), an "on" effect is displayed as a cell having the color that you chose for the [channel](#), and an "off" effect is displayed as a light grey cell. "Set intensity" is displayed as a color somewhere in between the two (depending upon the intensity chosen). For example, the following picture shows a sequence with two channels (one red and one green), each being on for the first half second, off for the next, then 50% on, then off again, then 20% on, and then off again:

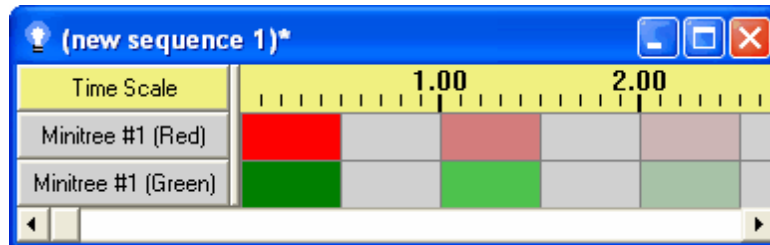

Different levels of intensity

Alternatively, you can choose to have varying intensities displayed not by varying colors, but by filling in the cells to varying degrees. This is done by selecting "[View Fades as Ramps](#)" from the [View menu](#) (or, to make this your default, by setting it in the [Display Preferences](#) dialog of the [Edit menu](#)). For example, here is the exact same sequence, but this time with "View Fades as Ramps" turned on:

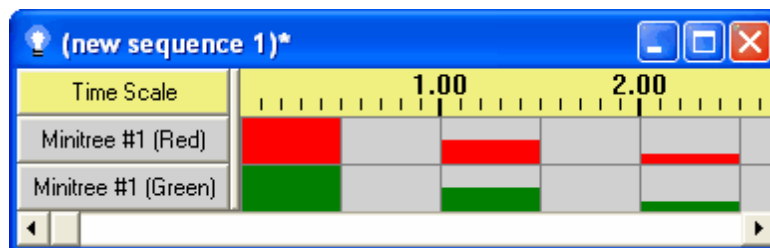

The same sequence, with "View Fades as Ramps" turned on

The brightness used by the "Set Intensity" tool can be controlled by the [Intensity Tool Settings](#) dialog:

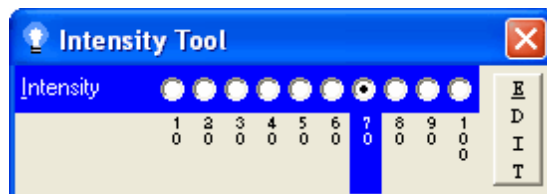

The Intensity Tool Settings dialog, with 70% intensity selected

Any of the ten values listed on the Intensity Tool Settings dialog can be changed, by clicking its "Edit" button to open the [Intensity Tool Options](#) dialog.

In the [Tools toolbar](#), the "On" tool's button shows a green square, the "Off" tool's shows a red square, and the "Set Intensity" tool's shows three green columns of varying heights. Additionally, there is a "Toggle" tool, which can be used to turn any cell that is off to on, and any other cell to off. The "Toggle" tool's button shows two blue squares, one in front of the other. Finally, the Intensity Tool Settings dialog's button looks like the Set Intensity button, but with a question mark in front of it:

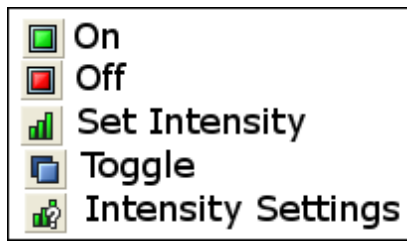

Intensity-related toolbar buttons

"Set Intensity" is only supported on [Light-O-Rama controllers](#). If it is used on a different device type, any intensity greater than 10% is considered "on", and lesser percentages are considered "off".

Twinkle

The "Twinkle" effect causes your lights to quickly vary between on and off.

The difference between "Twinkle" and "[Shimmer](#)" is that twinkle is more random: Two different strings of lights that are both told to shimmer at the same time will quickly turn off and on in sync with each other; if they are instead told to twinkle, they will still quickly turn off and on, but not in sync with each other.

In the [Sequence Editor](#), twinkle is represented with crossed diagonal hatching:

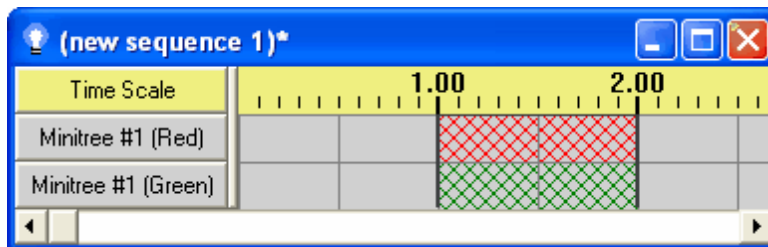

Two channels, each with twinkle between 1 and 2 seconds

On the Tools toolbar, the Twinkle tool is represented by a button with stars on it:



The twinkle toolbar button

Twinkle is only supported on [Light-O-Rama controllers](#). If it is used on a different device type, it will simply turn the lights on to their full brightness.

The Twinkle tool itself twinkles the lights at full intensity. You can also twinkle the lights while fading up or fading down, or at some intensity other than full intensity, by using a [custom tool](#) instead of the Twinkle tool.

Shimmer

The "Shimmer" effect causes your lights to quickly vary between on and off.

The difference between "Shimmer" and "[Twinkle](#)" is that twinkle is more random: Two different strings of lights that are both told to shimmer at the same time will quickly turn off and on in sync

with each other; if they are instead told to twinkle, they will still quickly turn off and on, but not in sync with each other.

In the [Sequence Editor](#), shimmer is represented with diagonal lines:

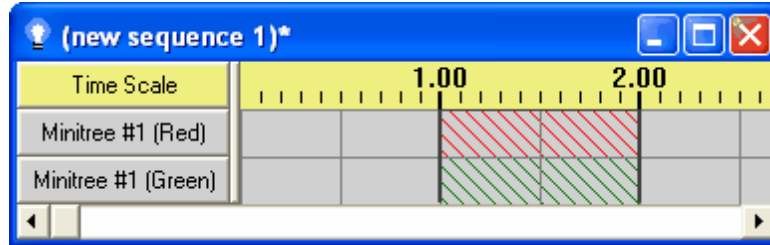

Two channels, each with shimmer between 1 second and 2 seconds

On the [Tools toolbar](#), the Shimmer tool is represented by a button with wavy lines:

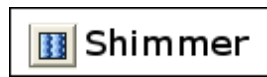

The shimmer toolbar button

Shimmer is only supported on [Light-O-Rama controllers](#). If it is used on a different device type, it will simply turn the lights on to their full brightness.

The Shimmer tool itself shimmers the lights at full intensity. You can also shimmer the lights while fading up or fading down, or at some intensity other than full intensity, by using a [custom tool](#) instead of the Shimmer tool.

Fade Up and Fade Down

The fade tools will make the brightness of your lights gradually change, either brighter or less bright. Both the starting brightness and the ending brightness can be specified, anywhere from 0% to 100%, as can the length of time that it takes to fade from one to the other.

In the [Sequence Editor](#), fades are represented by gradually varying colors, between light grey (representing 0%) and the color that you assigned to the [channel](#) (representing 100%). For example, the following picture shows a [sequence](#) with four channels (two red and two green), all fading over the course of the first second of the sequence. The first channel fades up from 0% to 100%; the second from 25% to 100%; the third fades down from 100% to 0%; the fourth from 100% to 25%:

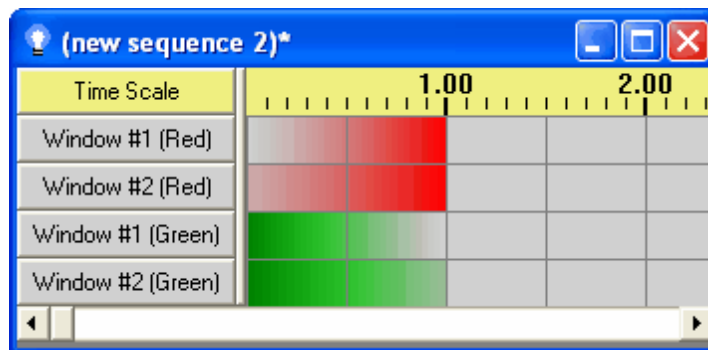

Four different fades

Alternatively, you can choose to have fades displayed not by varying colors, but by filling in the cells to varying degrees. This is done by selecting "[View Fades as Ramps](#)" from the [View menu](#) (or, to make this your default, by setting it in the [Display Preferences](#) dialog of the [Edit menu](#)). For example, here is the exact same sequence, but this time with "View Fades as Ramps" turned on:

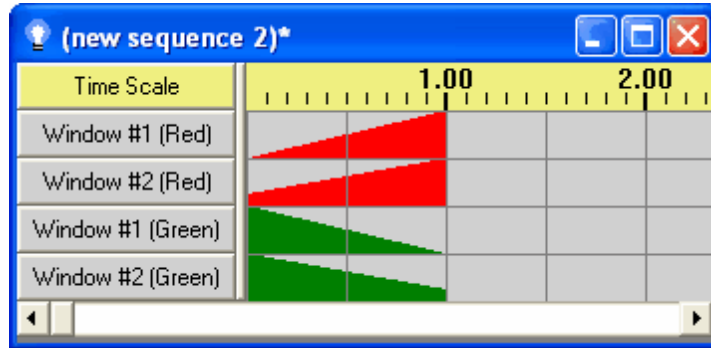

The same sequence, with "View Fades as Ramps" turned on

The starting and ending brightnesses used by the Fade Up and Fade Down tools can be controlled via the [Fade Tool Settings](#) dialog:

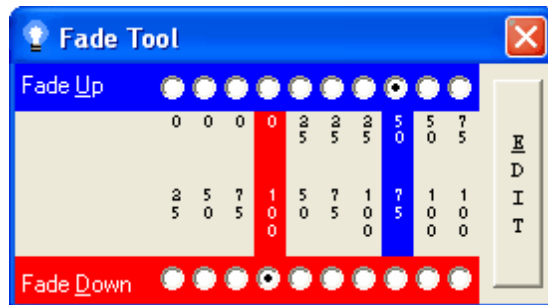

The Fade Tool Settings dialog, with fade up 50%-75% and fade down 100%-0% selected

Any of the ten values on the Fade Tool Settings dialog can be changed, by clicking its "Edit" button to open up the [Fade Tool Options](#) dialog.

On the [Tools toolbar](#), the Fade Up and Fade Down tools are represented as blue up and down arrows in front of green triangles. The Fade Tool Settings dialog's button looks like that of the Fade Up tool, but with a question mark in front of it:

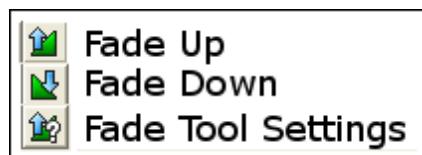

Fade-related toolbar buttons

Fades are only supported on [Light-O-Rama controllers](#). If one is used on a different device type, it will simply immediately turn the lights completely on or completely off, based on the ending brightness of the fade (fades ending at greater than 10% brightness are considered "on", and others are considered "off").

Custom Fade/Intensity Twinkles and Shimmers

Only one of the [Twinkle](#), [Shimmer](#), [Fade Up](#), [Fade Down](#), and [Set Intensity](#) tools can be selected at any given time. They can therefore be used, for example, to twinkle the lights, or to fade the lights up, but not both. However, you can still twinkle the lights while fading them up, in another way: By using the Custom tool.

On the [Tools toolbar](#), the Custom tool is shown as a large yellow star. To the right of it are five buttons, which are enabled when the Custom tool is selected (and disabled if any other tool is selected). These five buttons allow you to select "twinkle" or "shimmer", and "set intensity", "fade up", or "fade down". Each of these five looks like the corresponding button for the base effect (such as "twinkle"), with a smaller yellow star in its lower right corner.

For example, to select a tool that will let you twinkle the lights while fading them up, select the yellow star "Custom" button. The five custom option buttons will then become enabled; select the "Custom Twinkle" button *and* the "Custom Fade Up" button.

The regular fade tool settings apply to faded twinkles and shimmers, and the regular set intensity tool settings apply to set intensity twinkles and shimmers.

If you have an older [Light-O-Rama controller](#), it may need a [firmware upgrade](#) before it will be able to twinkle or shimmer while fading, or at any intensity other than full intensity. If a custom twinkle or shimmer is sent to such a controller that does not have the appropriate firmware upgrade, it will react as it would to a "standard" twinkle or shimmer - i.e. it will twinkle or shimmer at full intensity.

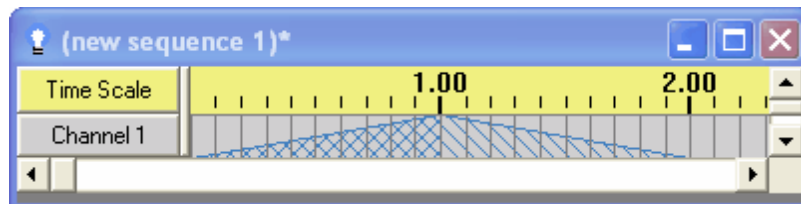

A twinkling fade up followed by a shimmering fade down



Toolbar icons for custom twinkles and shimmers

DMX Intensity

The intensity for most [effects](#) - such as [fades](#) - can vary between zero and 100. The DMX intensity effect, however, can vary between zero and 255.

This is useful for sending DMX commands to DMX devices via a [Light-O-Rama controller](#); the DMX protocol supports intensities from zero to 255, and so this effect allows Light-O-Rama to send any of the 256 possible DMX intensities to a device, instead of only 101 of them. However, please note that not all Light-O-Rama controllers support this functionality; DMX intensity events sent to a

controller that does not support them will simply be ignored. To check whether any particular controller supports it, please refer to that controller's documentation.

The DMX intensity tool is not enabled in the [Sequence Editor](#) by default - that is, by default, the Sequence Editor will not show a toolbar button for the DMX intensity tool, nor a menu item in the [Tools menu](#), nor allow a [keyboard shortcut](#) for it. To enable these things, make sure that "Allow DMX Editing" is checked in your [DMX Preferences](#).

DMX Intensity

The DMX Intensity toolbar button

When DMX editing is enabled and the DMX intensity tool is selected, a dialog will appear allowing you to set the exact DMX intensity that will be used whenever the tool is used on a cell or group of cells:

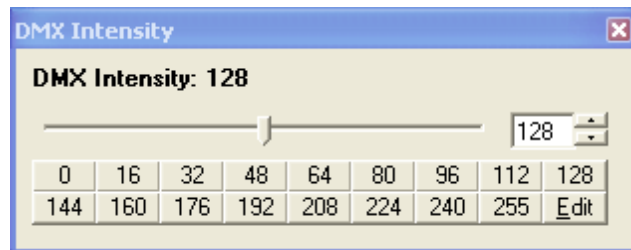

The DMX Intensity dialog

The intensity can be set in this dialog in several ways: by moving the slider, by typing in the text box, by using the up/down buttons next to the text box, or by selecting any of the preset intensity buttons. Additionally, the values of the preset buttons can be changed by clicking the "Edit" button:

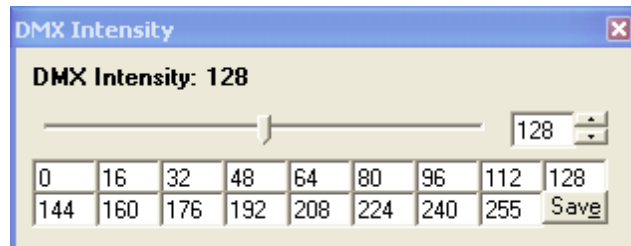

Editing the DMX Intensity dialog's preset intensities

After modifying the preset intensities using these text boxes, click "Save" to go back to showing the buttons instead of the text boxes. Note: When you click "Edit", Light-O-Rama will automatically sort the values that you entered so that they are displayed from lowest to highest, regardless of the order that you entered them in. Also, if you enter any particular value more than once, Light-O-Rama will automatically filter out the duplicates, and replace them with values that are in between those that you have entered.

The Sequence Editor displays DMX intensity effects using a checkerboard pattern:

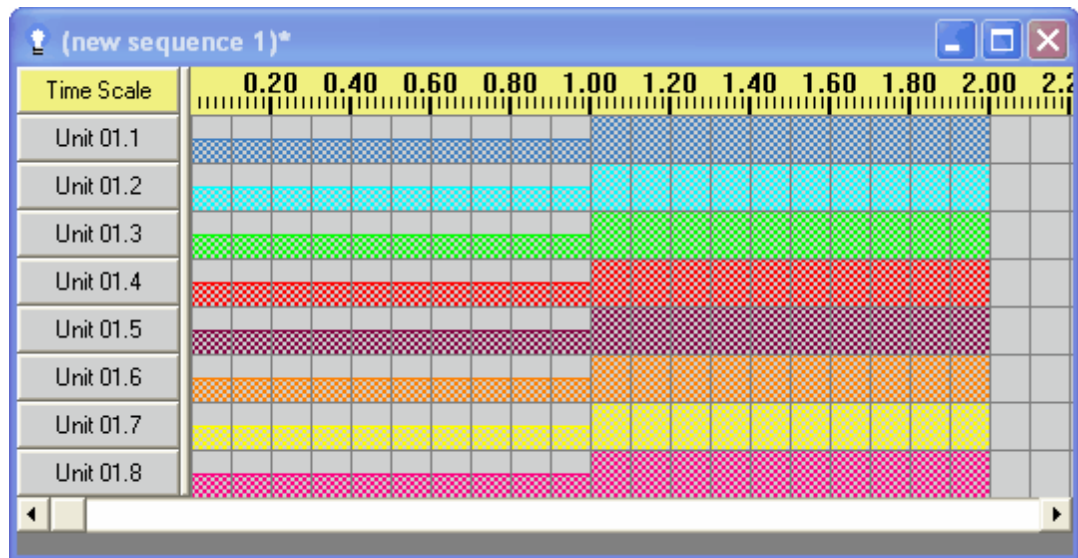

Several channels, each with a DMX intensity of 128 followed by a DMX intensity of 255

Background and Foreground Effects

Background and foreground effects are not themselves [effects](#), but are rather modes of editing effects in the [Sequence Editor](#). These modes affect the behavior of tools (such as "[Twinkle](#)" and "[Fade Up](#)") in the following manner:

If background effects have been turned on, the tool only applies to those selected cells that are completely off (that is, at intensity zero for their entire duration).

If foreground effects have been turned on, the tool only applies to those selected cells that are *not* completely off.

If neither background effects nor foreground effects have been turned on, the tool will apply to all selected cells. This is referred to as "regular effects".

Some examples:

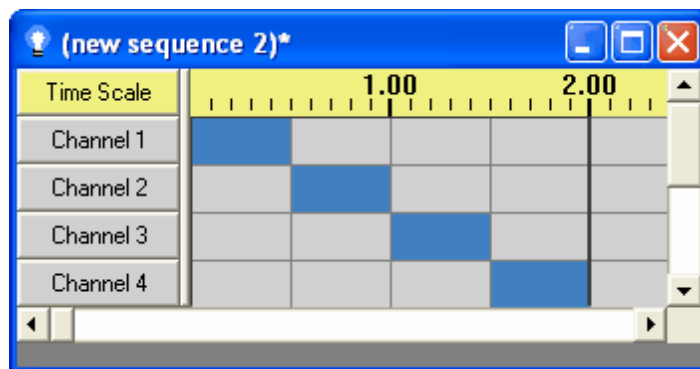

Before a background fade up

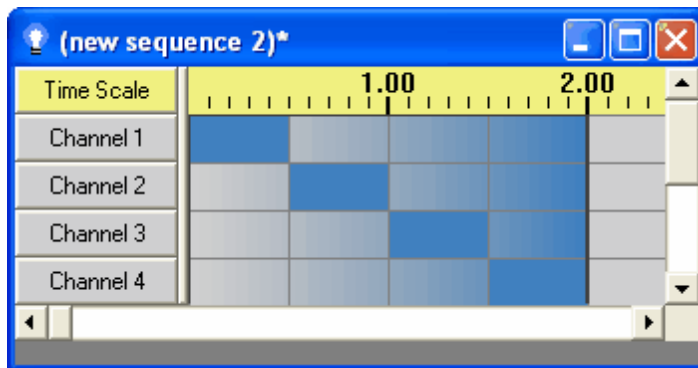

After a background fade up

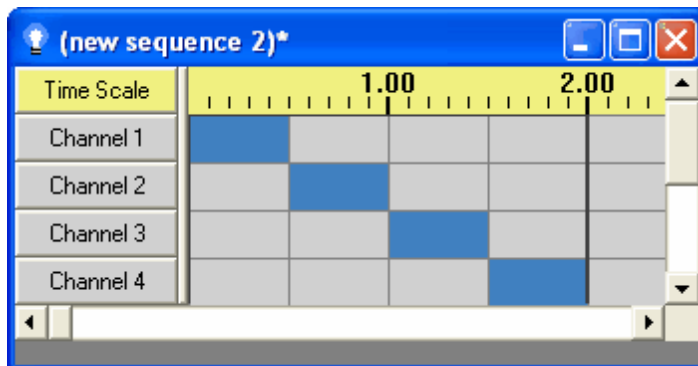

Before a foreground fade up

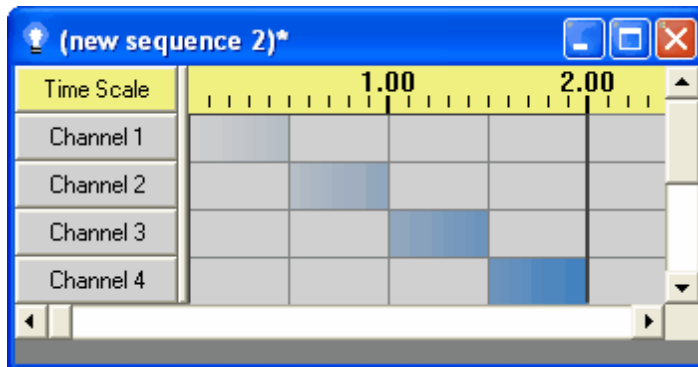

After a foreground fade up

Background and foreground effects can be turned on and off in several ways:

- Via the [Tools Menu](#) ("[Tools/Background Effects](#)" and "[Tools/Foreground Effects](#)");
- Via the [Tools toolbar](#);
- Via the [keyboard](#):
 - The "A" key ("**b**ackground") will cause the next keystroke (and only the next keystroke) to use background effects mode rather than whatever mode is currently selected;
 - "Shift-A" will cause background effects to be turned on until it is explicitly turned off;
 - Similarly, "O" and "Shift-O" ("**f**oreground") for foreground effects, and "E" and "Shift-E" ("**rE**gular") for regular effects (i.e. for turning off both background and foreground effects).

These tools are also available via the [effect grid's right-click popup menu](#), for single-shot use, like the other tools (for example "on", "twinkle", and "fade up").

 **Background Effects**
 **Foreground Effects**

The background and foreground effects toolbar buttons

4.1.8 Loops

An [animation sequence](#) (but not a [musical sequence](#)) can contain loops. When the [Show Player](#) or the [Sequence Editor](#) plays a sequence with loops, when the end of a loop is reached, the sequence will go back to the beginning of the loop. This will happen a certain number of times (which you specify), after which the sequence will continue on past the end of the loop.

Each time through a loop, you can have the sequence speed up, slow down, or remain at the same speed.

A sequence can contain many loops. Loops can be nested - that is, a loop can contain other loops.

In the Sequence Editor, loops are shown in a white row, above the grey rows representing channels. For example, the following picture shows a sequence with a loop starting at 1 second and ending at 2 seconds:

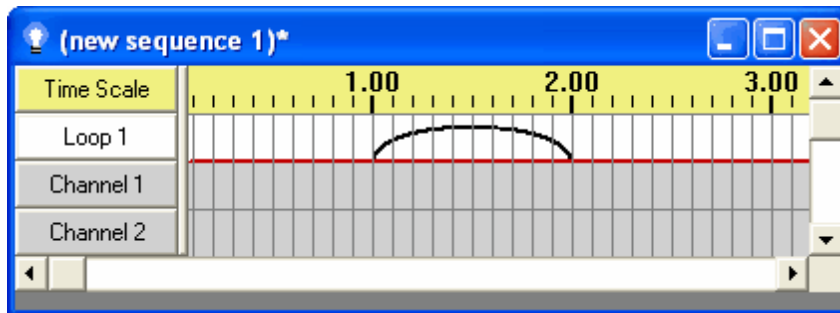

A sequence with a loop, starting at 1 second and ending at 2 seconds

More than one loop can be in a sequence. For example, here is the same sequence, with a second loop added, from 2.5 seconds to 3 seconds:

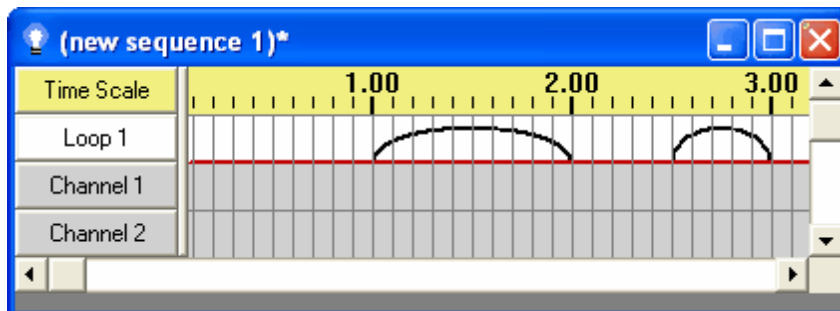

Two loops in a sequence

Loops can contain loops; this is represented by having multiple rows of loops. For example, in the following picture, a second loop level has been added, and a loop was put into it from 0.5 seconds to 3 seconds, thus containing both of the loops of the lowest loop level:

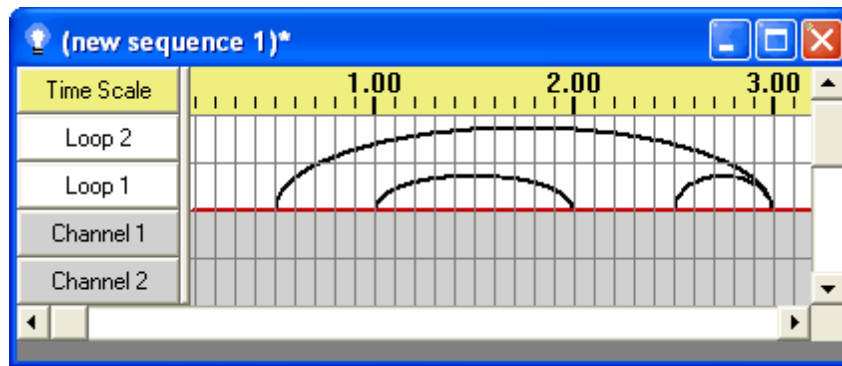

A loop containing loops

To use loops in an animation sequence, you first must use the "[Turn on Loops](#)" option in the [Edit menu](#) of the Sequence Editor (or, alternatively, specify that you want to use loops when you create the sequence in the [New Animation dialog](#)).

To create a loop, select the appropriate time range and the loop level, either by clicking and dragging [the mouse](#) in the white loop rows or by [using the keyboard](#). The [Loop Context menu](#) will pop up:

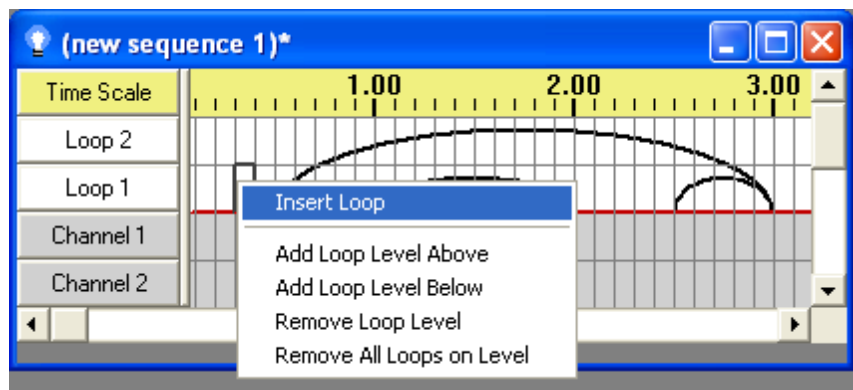

The Loop Context menu

After selecting "[Insert Loop](#)". You will then be prompted for how many times the loop should loop back, and then whether (and by how much) it should increase, decrease, or remain the same speed in each pass through the loop:

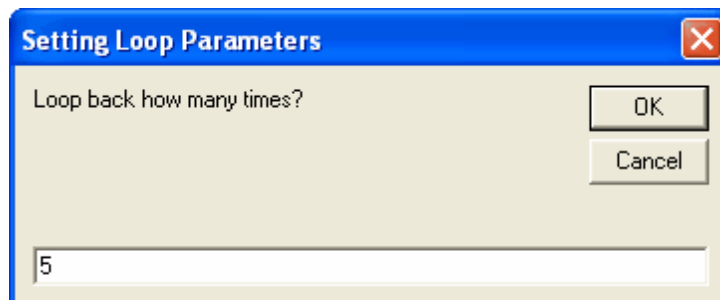

Inserting a loop: How many times should it loop back?

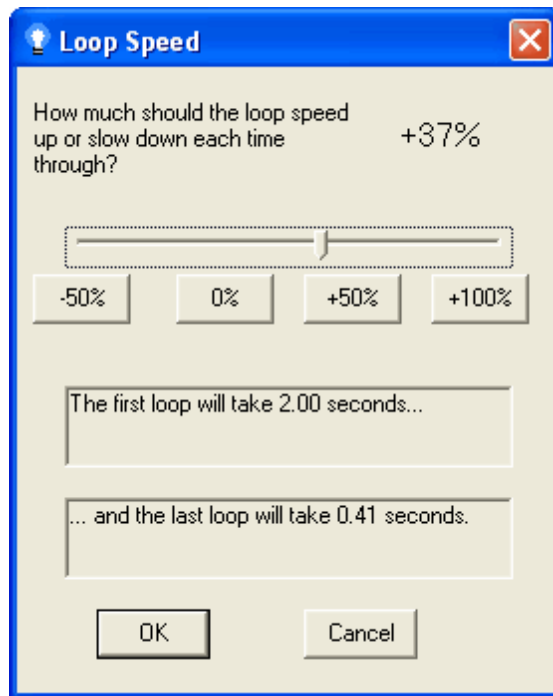

Inserting a loop: Should it speed up or slow down?

Clicking on an existing loop also brings up the Loop Context menu, but with additional menu items, such as [displaying information about the loop](#) and [removing the loop](#):

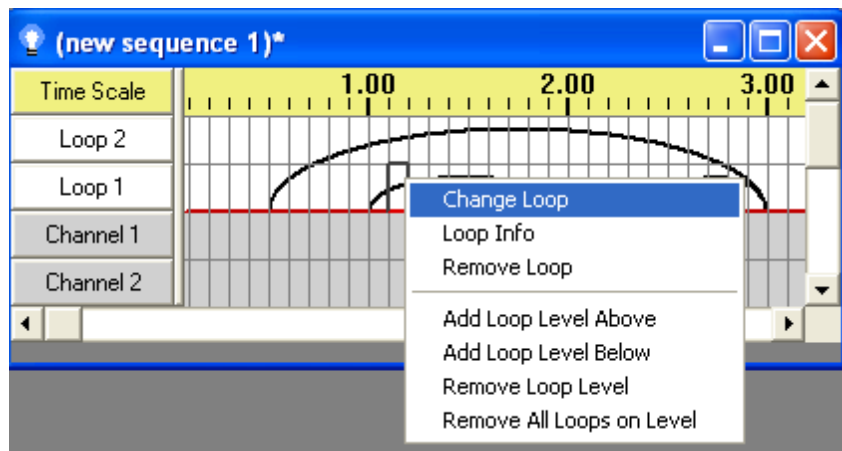

The Loop Context menu, on an existing loop

Several of these menu items can also be accessed by clicking on the [loop level's button](#) (specifically, the ones dealing with loop levels, such as "[Add Loop Level Above](#)" and "[Remove Loop Level](#)").

4.1.9 Tracks

A [sequence](#) can contain multiple tracks, with each track being a group of [channels](#). A channel can be in one track, or can be shared among multiple tracks. For example, the following sequence has two tracks, and two channels, with both of the channels being in both of the tracks:



Two tracks in one sequence, with the same channels in both tracks

Notice that the two tracks have different [timings](#) than each other - in this case, the top track has timings every tenth of a second, and the bottom track every half a second.

All sequences are initially created with a single track. There are a few ways to add another track using the [Sequence Editor](#):

- In the [Edit menu](#):
 - "[Add New Track](#)" will add a track with entirely new channels.
 - "[Duplicate Track](#)" will add a new track and share all of the channels of the currently selected track with it.
- On a [channel button's right-click popup menu](#):
 - "[Copy to New Track](#)" will add a new track and copy the channel to it, while also giving you the option to automatically insert new channels as well.
 - "[Move to New Track](#)" does much the same, except that the channel will be moved, not copied, to the new track.
- Using the [Tracks and Timings toolbar](#)

Important: To share a channel between tracks, make sure to use one of the above duplication or copying commands. Do *not* simply set two different channels in different tracks to the same unit ID, circuit number, et cetera. Doing that will have unexpected and undesired results, as the two different channels compete for control over the same physical circuit.

If a sequence has more than one track, each will be displayed with a preceding [track bar](#). The bar will be labeled with the track's number within the sequence (the track at the top is track #1, the next one down is track #2, and so forth). If the track is given a name (such as by "[Change Track Name](#)" of the [Edit menu](#)), it will also be displayed on the bar:

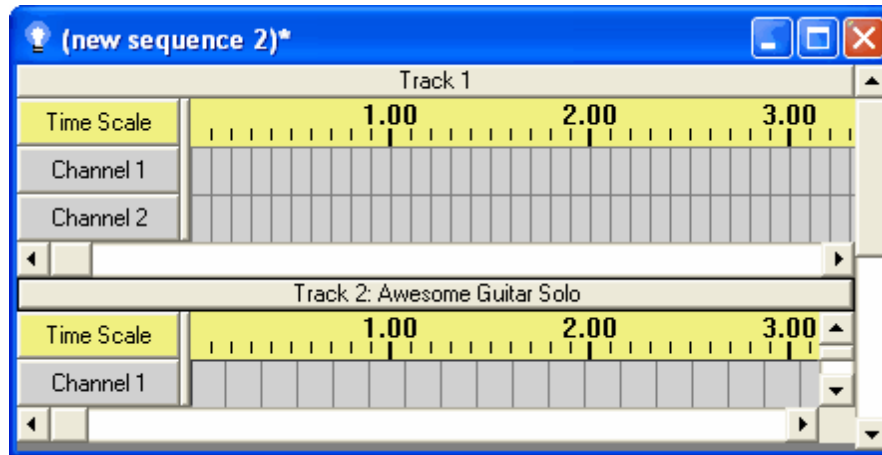

Track 1 has no name, while Track 2 is named "Awesome Guitar Solo"

Left-clicking on a track bar will [hide or unhide the track](#), while right-clicking on one will bring up the [track bar's popup menu](#), containing various track-related functions (such as [renaming the track](#), [moving the track up](#) or [down](#) in the sequence, [duplicating the track to a new track](#), or [deleting the track](#)):

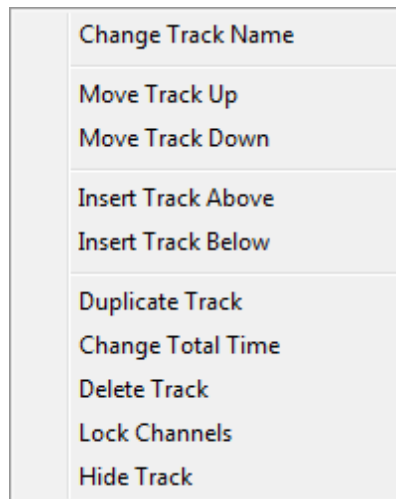

The track bar popup menu

If the "[Hide Track](#)" item on that popup menu is selected, the track will no longer be displayed. However, the track's track bar still will be, and will indicate that the track has been hidden; clicking on it again to bring up the popup menu will now allow you to "Show Track":

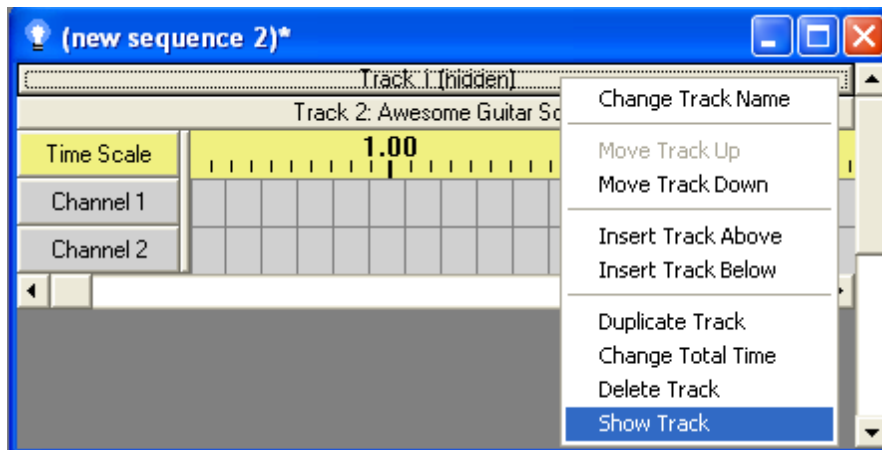

For more detail on these and other track-related functions, please see:

- [The Edit menu](#)
- [Channel buttons' right-click popup menus](#)
- [Track bars' popup menus](#)

4.1.10 Animations

NOTE: The Animator was created before the [Light-O-Rama Visualizer](#) existed; the Visualizer is more fully featured than the Animator. The Animator is still supported so that existing sequences continue to work, but consider using the Visualizer instead of the Animator, especially for new sequences.

Each [sequence](#) that you create may have an animation associated with it. This is a simple drawing of the layout of the lights that will be used in the sequence. Note that this "animation" should not be confused with "[animation sequence](#)". Both animation sequences and [musical sequences](#) can have animations.

When you play a sequence using the [Sequence Editor](#), you can also watch the sequence's animation. The drawing will change as if it were the lights that the sequence controls - that is, parts of the drawing will turn on and off, fade up and down, twinkle, and shimmer, just as the sequence commands.

A sequence's animation can be assigned a background image (for example, a photo of your house), which you can draw the lights on top of.

To view or edit a sequence's animation in the Sequence Editor, select "[Animation](#)" from the [View menu](#), or click the "[View Animation](#)" button in the [Standard toolbar](#).

For details on how to create and modify animations, please see [the Animator](#).

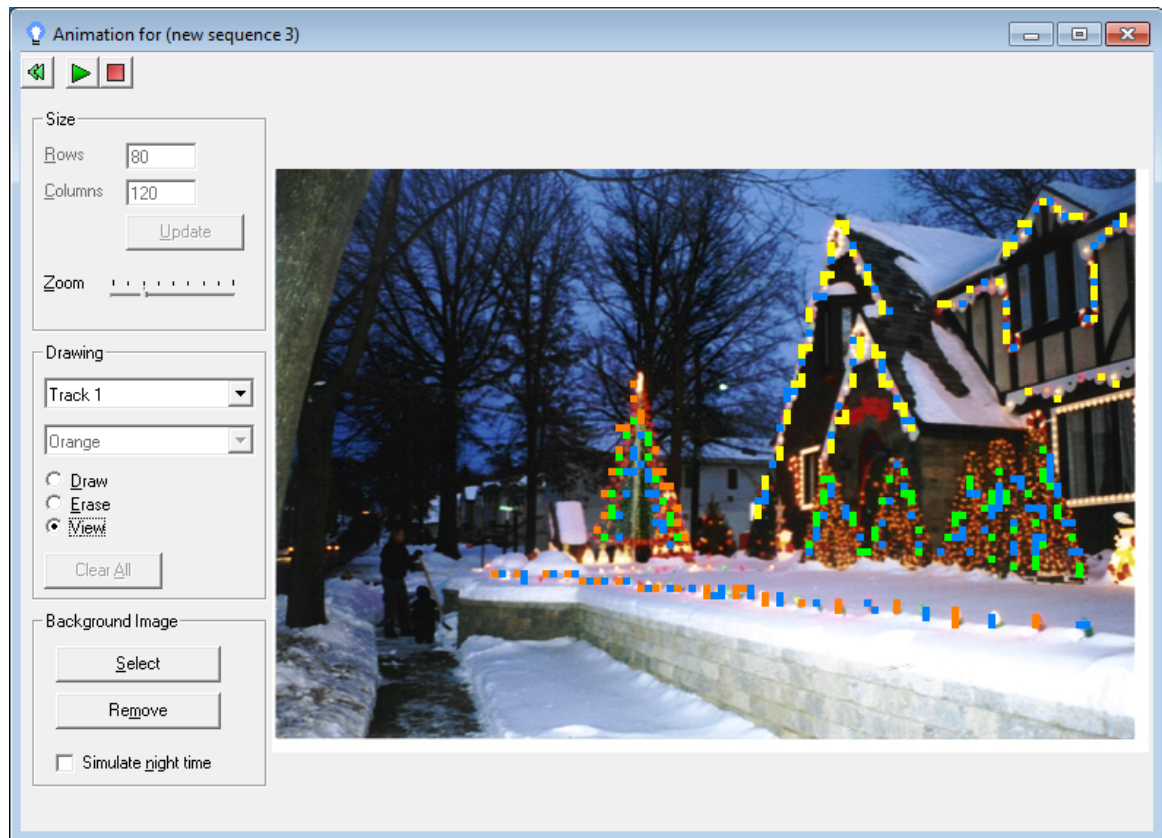

The Animator, with lights drawn on top of a background photo of a house

4.1.11 Subsequences

A subsequence is a [sequence](#) that is used as a part of another sequence (its "parent sequence", or "the main sequence"). The subsequence is represented in the main sequence as a [channel](#), with a special device type of "Sequence", as opposed to "[Light-O-Rama controller](#)", "[X10 controller](#)", or so forth.

For example, the following Channel Settings dialog shows a channel that is a subsequence:

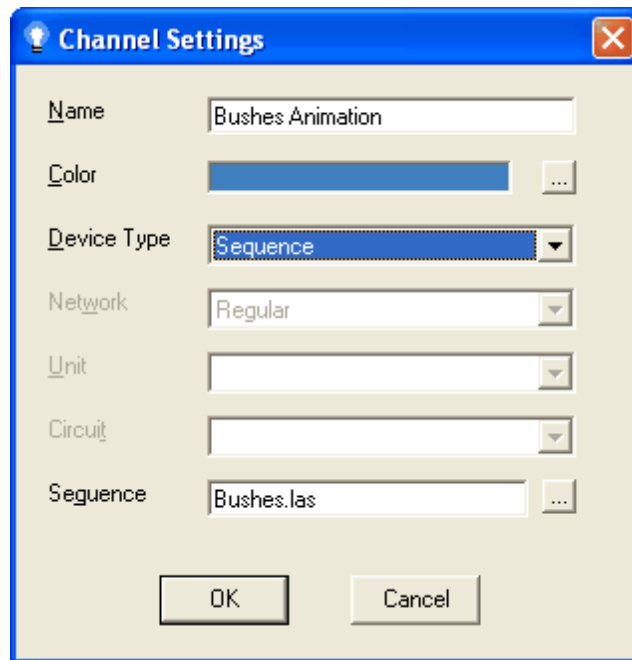

Channel settings for a subsequence

A channel for a subsequence can be turned on and off, using the [Sequence Editor](#), in the same ways that other channels can be. When the channel in the main sequence is turned on, the subsequence will begin playing, from its beginning. It will continue playing for as long as the channel remains on; if play of the subsequence reaches its end before the channel has been turned off in the main sequence, the subsequence will simply loop back to its beginning and continue playing.

When the channel in the main sequence is turned off, the subsequence will stop playing. If the channel is subsequently turned back on, the subsequence will start playing again, from its beginning (not from the last point that it left off at).

If you have the [Animator](#) open, it will *not* show the play of your subsequence. Only the events in your main sequence will be displayed. This only affects the display in the Animator; your actual lights will reflect play of both the main sequence and its subsequences.

Tip: Do not set up the same physical unit and circuit to be a channel in a sequence *and* a channel in a subsequence of that sequence (or two channels in two different subsequences of a sequence). Doing so will likely cause unexpected and undesired results, as the two channels compete for control over the same physical circuit.

Tip: Consider using the new [Paint Sequence tool](#) instead of subsequences; it can be used to accomplish some of the same things as subsequences, without the extra complication, and perhaps in a more obvious way. As opposed to subsequences, the [effects](#) generated via Paint Sequence really do become effects in the sequence being painted into, and are displayed in regular channels of the sequence just like any other effects in the sequence. The main advantage remaining to subsequences is that if you update the effects in the subsequence file, the change will take place in the main sequence as well. If this is not necessary or desired, Paint Sequence may be a better, easier, and clearer choice.

4.1.12 Windows Shell Commands

When a [sequence](#) is started, Light-O-Rama can optionally also execute an arbitrary Windows command, running any program that you specify.

For example, some people broadcast the songs that play during their [shows](#) over radio, and would like the name of the song to be broadcast along with it, using the RDS ("Radio Data System") protocol, allowing people with RDS-enabled radios to see the name of the song that they are listening to. RDS is not *directly* supported by Light-O-Rama, but you could set up your [musical sequences](#) so that, whenever one of them is played, Light-O-Rama will tell Windows to tell your RDS program to broadcast the name of the song for that [sequence](#).

To set up a sequence to execute a Windows command, select "[Windows Command](#)" from the [Sequence Editor's Edit menu](#). After that, whenever that sequence is played (either by the Sequence Editor or the [Show Player](#)), the command will be executed.

Note, though: If the Show Player is running when you change the command associated with a sequence, you may have to stop and start the Show Player in order for this change to be picked up.

This feature is available only for the [Advanced feature level](#).

- [Shell Command Variables](#)
- [Sharing Sequences between Computers, and Security](#)

Shell Command Variables

For the most part, a shell command will be executed exactly as you type it. You can, however, additionally use certain variables, which will be replaced at run-time with various information, such as the title of the song associated with the sequence. The following variables can be used (*note: the exact result of using any of the date/time "DT_" variables may depend upon your computer system, so try them out if you need to rely upon an exact format*):

Variable	Meaning
%%	A single percent character ("%")
%DT_a%	Day of week, abbreviated ("Mon")
%DT_A%	Day of week ("Monday")
%DT_b%	Month name, abbreviated ("Aug")
%DT_B%	Month name ("August")
%DT_c%	Date and time ("Mon Nov 29 16:32:37 2010")
%DT_d%	Day of month (01 through 31)
%DT_H%	Hour, 24 hour clock (00 through 23)
%DT_I%	Hour, 12 hour clock (01 through 12)
%DT_j%	Day of year (001 through 366)
%DT_m%	Month number (01 through 12)
%DT_M%	Minute (00 through 59)
%DT_p%	AM or PM
%DT_S%	Second (00 through 61)
%DT_U%	Week of year, with the first Sunday of the year starting week 01 (00 through 53)

%DT_w%	Day of week, number (0 through 6, Sunday being 0)
%DT_W%	Week of year, with the first Monday of the year starting week 01 (00 through 53)
%DT_x%	Date ("11/29/10")
%DT_X%	Time ("16:32:37")
%DT_y%	Year, two digit ("10")
%DT_Y%	Year, four digit ("2010")
%DT_Z%	Time zone ("EST")
%ENV_ something%	The value of your computer's environment variable "something"; for example, use %ENV_PATH% to get the value of your computer's PATH environment variable
%MEDIA_ALBUM%	The name of the album that this sequence's media file is from (if set in your sequence)
%MEDIA_ARTIST%	The name of the artist that this sequence's media file is by (if set in your sequence)
%MEDIA_FILENAME%	The name of the sequence's media file, without path information
% MEDIA_FILENAME_FULL %	The name of the sequence's media file, with path information
% MEDIA_FILENAME_NO_E XT%	The name of the sequence's media file, without path information and without the file extension (such as ".mp3")
%MEDIA_TITLE%	The name of the song that this sequence's media file is (if set in your sequence)
%SEQUENCE_AUTHOR%	The author of this sequence (if set in your sequence)
% SEQUENCE_CREATED_A T%	The date and time at which the sequence was created
%SEQUENCE_FILENAME %	The name of the sequence file, without path information
% SEQUENCE_FILENAME_ FULL%	The name of the sequence file, with path information
% SEQUENCE_FILENAME_ NO_EXT%	The name of the sequence file, without path information and without the file extension (such as ".lms")
% SEQUENCE_MODIFIED_B Y%	The name of the person who has modified the sequence (if set in your sequence)

Sharing Sequences between Computers, and Security

The ability to execute an arbitrary Windows command is very powerful, and even potentially harmful - for example, you could execute a command which will install spyware on your machine. Therefore, it would

not be wise to execute whatever Windows command another person chose, unless you are absolutely sure that the command they chose is safe and harmless.

For this reason, Light-O-Rama imposes a security measure: The command to be executed is *not* stored directly in the sequence file itself. Instead, the sequence file contains a key for an entry in another file ("cmdmap.lcm", located in your Light-O-Rama sequences directory); that entry specifies the Windows command to be executed. If that file doesn't contain an entry for that key, Light-O-Rama simply does not execute any command when the sequence plays.

So, you can use sequences created by other people without fear of spyware or other harmful programs, as long as you continue to use your own version of cmdmap.lcm, not a copy of the other person's cmdmap.lcm.

However, this means that if you yourself use Light-O-Rama on two separate machines - for example one to create your sequences on, and another to run your shows on - you will have to copy your "real" version of cmdmap.lcm from one machine to the other if you want your sequences to execute Windows shell commands. You would typically do this at the same time that you copy your sequences themselves over from one machine to the other.

4.1.13 Compressed Sequences

The layout of a Light-O-Rama [sequence](#) file is somewhat verbose. This is intended to make it easier for third party tools which use LOR sequence files to be created. However, it has a drawback: Large sequences may be fairly slow to load. When loading a large sequence in the [Sequence Editor](#), this may be an inconvenience. But the real problem is when loading a large sequence in the [Show Player](#): It may take several seconds, during which time your show is effectively paused.

To resolve this issue, Light-O-Rama now supports the concept of a "compressed sequence". A compressed sequence is a separate save file, associated with a sequence but containing only enough information to play the sequence in the Show Player, and optimized for loading speed. This can speed up loading times dramatically - for example, for a certain large sequence that takes eight seconds to load on a certain computer, the associated compressed sequence only takes a small fraction of a second to load on that same computer.

Light-O-Rama will automatically create compressed sequences whenever appropriate, and the Show Player will automatically use them instead of the associated sequence file whenever they are present. So, you should not have to take any steps in order to start taking advantage of this feature. You can, however, prevent the Show Player from using compressed sequences (for example, if something unexpected goes wrong with them), in which case it will simply use the sequences instead. This can be controlled through the [LOR Control Panel's](#) "[Use Compressed Sequences](#)" option.

Not all sequences can have compressed sequences associated with them; if a sequence contains [loops](#), or if it contains two or more [tracks](#) that have different time lengths than each other, it cannot have a compressed sequence. There are no other restrictions on what sequences can have compressed sequences. So, since [musical sequences](#) also cannot have loops or tracks of different lengths, note that this means in particular that all musical sequences can have compressed sequences.

Assuming that a compressed sequence can be associated with a sequence, then the Sequence Editor will automatically save a compressed sequence whenever it saves a sequence.

Assuming that you do not turn "Use Compressed Sequences" off, the way that the Show Player handles sequences and compressed sequences is this:

When your show calls for a certain sequence to be loaded, the Show Player will first check to see if there is a compressed sequence associated with that sequence. If so, and if the compressed sequence is more recent than the sequence, it will load the compressed sequence instead of the sequence.

Otherwise, it will load the sequence. After loading the sequence, it will check whether or not a compressed sequence can be made for it, and, if so, it will create the compressed sequence. This is so that in future runs of the show, it can simply use the compressed sequence instead of the sequence.

4.1.14 Protected Sequences

A protected sequence is a [sequence](#) which, generally speaking, cannot be modified, and whose sequence grid cannot be viewed in the [Sequence Editor](#). Protected sequences can, however, be played just like any other sequence; they can be [scheduled](#) in your [shows](#), they can be played in the Sequence Editor, they can be [downloaded as standalone sequences](#), and they will control your lights.

There are some things about a protected sequence which can be modified:

- The location of the media file (via [Edit / Media File](#));
- The [animation](#) (via [View / Animation](#));
- The [Windows shell command](#) (via [Edit / Windows Command](#)).

To create a protected sequence, open the sequence which you wish to protect, and then select "[Export as Protected](#)" from the [File menu](#). It will prompt you to select a filename for the protected sequence; note that you should *not* use the same filename as the original (unprotected) sequence itself, because if you do, you will no longer be able to modify that sequence. Instead, select a different filename; by default, the Light-O-Rama software will suggest "Protected-" followed by the original sequence's filename. For example, if your original, unprotected sequence is named "MySequence.lms", Light-O-Rama will suggest "Protected-MySequence.lms" for the filename of the protected sequence.

The ability to create a protected sequence is available only with the [Advanced license level](#).

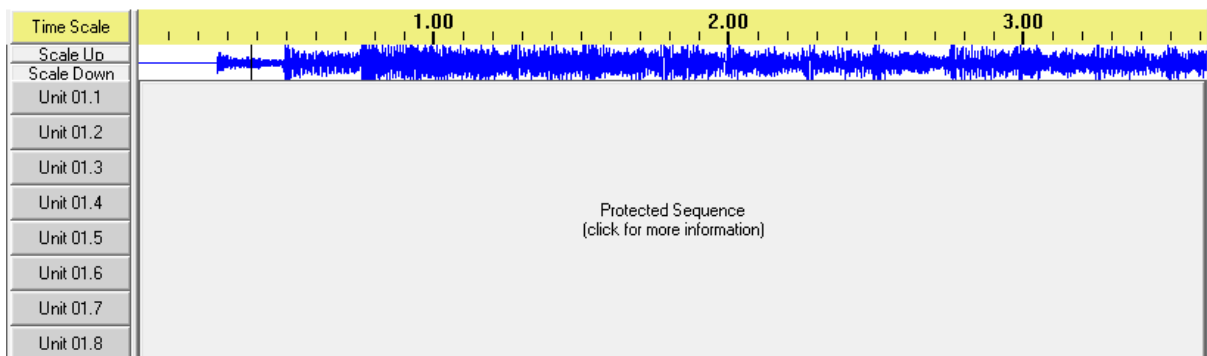

A protected sequence, as displayed in the Sequence Editor

4.2 Shows

What is a Show?

A show is a collection of [sequences](#), to be played as a set. After creating sequences with the [Sequence Editor](#), you can build a show from them using the [Show Editor](#). Shows can then be [scheduled](#) to play at certain times, using the [Schedule Editor](#), and are then actually played by the [Show Player](#).

Assuming that your [license level](#) is at least Basic Plus, you can also [cause a show to be played on demand](#), without scheduling it, via the [Light-O-Rama Control Panel](#).

There are six different parts to a show, each of which consists of sequences:

- [The Background Section](#)
- [The Startup Section](#)
- [The Animation Section](#)
- [The Musical Section](#)
- [The Interactive Section](#)
- [The Shutdown Section](#)

Each of these parts is optional. For example, a show can be built having only a musical section and a shutdown section.

By default, when a show is being played in the Show Player, any given sequence in the show will not be loaded until when it is about to be played for the first time. Depending upon the size of the sequence and the power of the computer, it may take a human-noticeable amount of time to load a sequence; if so, this may cause an undesired delay between sequences, the first time they are played. So, optionally, you can choose to [preload all sequences](#) before any of them are played.

Additionally, if your [Light-O-Rama software license](#) is for the Advanced feature level, you can modify exactly how your show will start up - for example, immediately at its scheduled start time, or after a certain [circuit](#) on a certain [Light-O-Rama controller](#) has been triggered (for example, by someone hitting a "start" button). See "[Show Startup Options](#)" for details.

Note that the duration of a show is not part of the show itself; rather, it is determined by the schedule.

The Background Section

When a show is started (at a time determined by the [schedule](#)), all of the [sequences](#) in the show's background section will start playing, simultaneously. When such a sequence reaches its end, it will simply loop back to its beginning and keep playing. All of these sequences will continue playing in this way until the show ends (also at a time determined by the schedule).

If your [Light-O-Rama software license](#) is for the Advanced feature level, you additionally have control over whether this section (and/or the rest of your show) starts immediately at its scheduled time, or upon an input trigger (for example, when someone hits a "start" button). See "[Show Startup Options](#)" for details.

Only [animation sequences](#) can be used in the background section of a show.

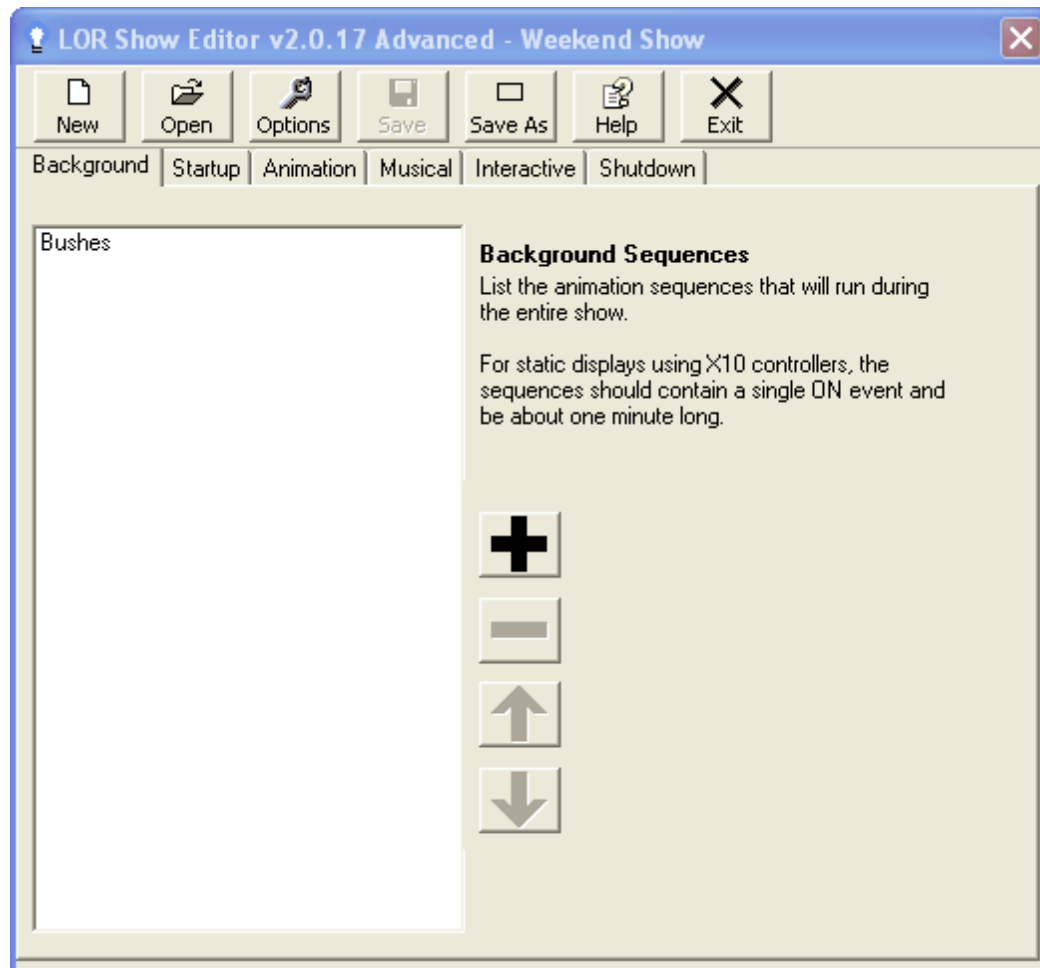

The Show Editor's tab for the background section of a show, with one sequence

The Startup Section

When a show is started (at a time determined by the [schedule](#)), the sequences in its startup section will be played, one at a time, in order. After they all have finished, the main portion of the show will begin, consisting of the [animation section](#) and the [musical section](#).

You can control whether or not sequences in this section will automatically turn their lights off when they reach their end by setting the "Turn used lights off at the end of each sequence" checkbox.

If your [Light-O-Rama software license](#) is for the Advanced feature level, you additionally have control over whether this section (and the rest of your show) starts immediately at its scheduled time, or upon an input trigger (for example, when someone hits a "start" button). See "[Show Startup Options](#)" for details.

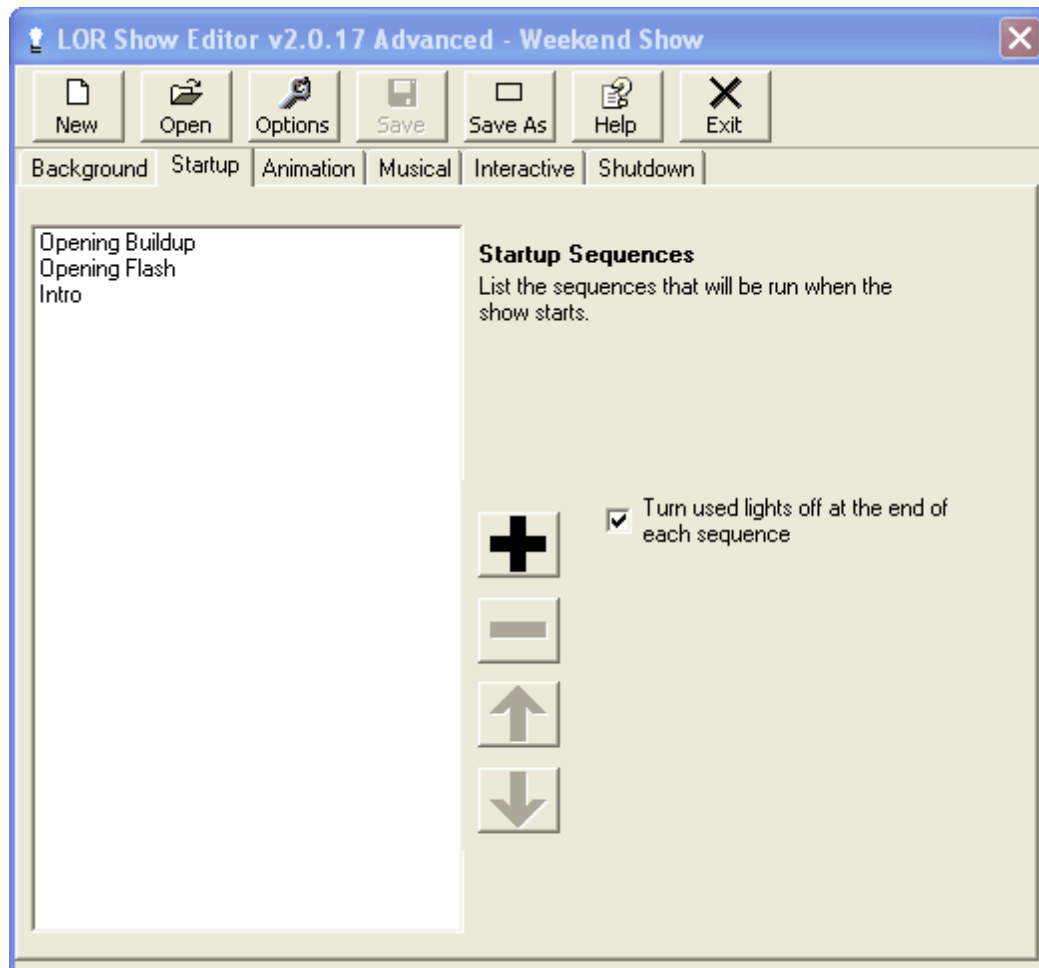

The startup section in the Show Editor, with three sequences

The Animation Section

After a show's [startup section](#) has completed, its animation section will begin (as will its [musical section](#)).

[Sequences](#) in the animation section can be played concurrently or sequentially. If you choose to play them sequentially, the first in the list (as displayed in the [Show Editor](#)) will be played, and when it finishes, the next will be played, and so forth. After all of them have been played, the first in the list will be played again. This pattern will continue until the show is shut down (at a time determined by the [schedule](#)).

If they are played concurrently, all of them will be played at once, and whenever one reaches its end, it will simply loop back to its beginning and keep playing. Again, this will continue until the show is shut down.

You can control whether or not sequences in this section will automatically turn their lights off when they reach their end by setting the "Turn used lights off at the end of each sequence" checkbox.

Only [animation sequences](#) can be used in the animation section of a show.

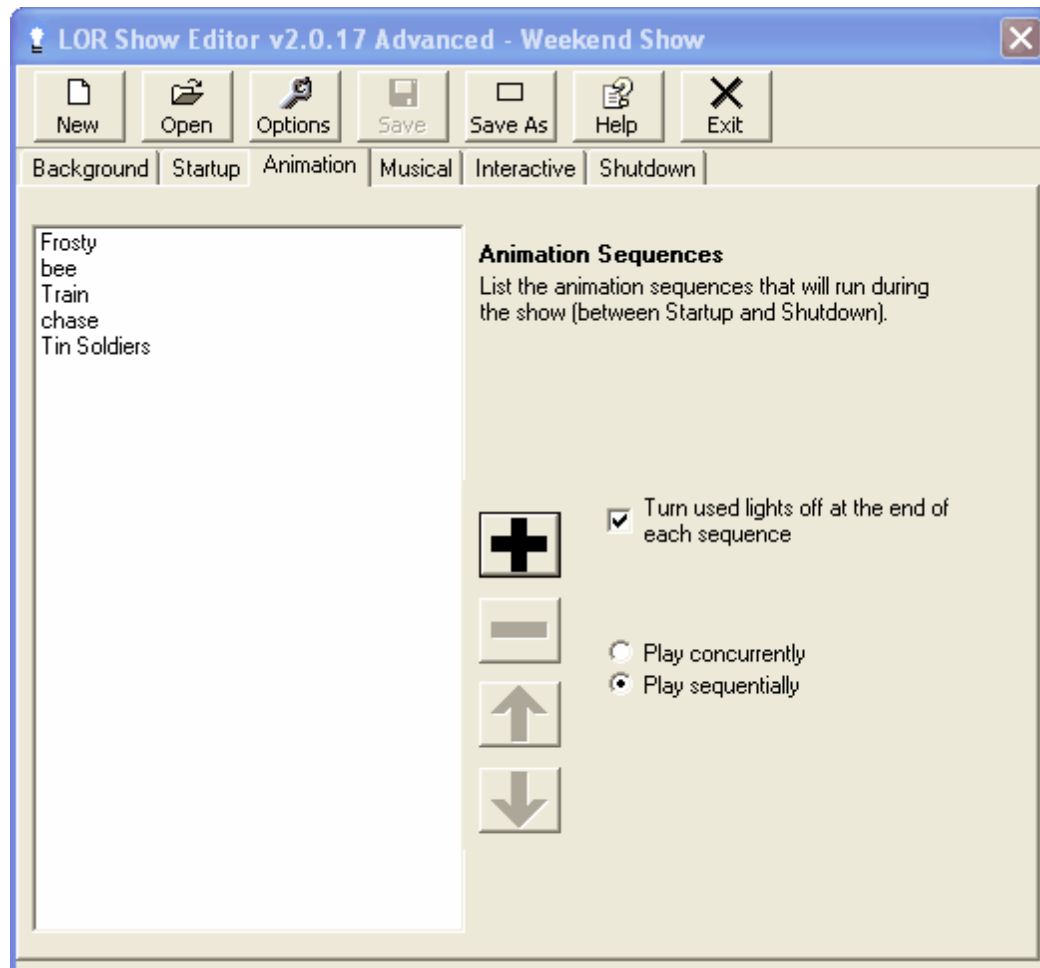

The animation section in the Show Editor, with five sequences, played sequentially

The Musical Section

After a show's [startup section](#) has completed, its musical section will begin (as will its [animation section](#)).

Only one [sequence](#) from the musical section will play at a time. They can be played in the order listed in the [Show Editor](#), or shuffled randomly. If shuffled randomly, you can also control two different aspects of how shuffling is done: Whether or not a sequence is allowed to be played a second time before all sequences have played once, and whether or not a sequence is allowed to play twice in a row (this latter does not apply if you have only one sequence in the musical section - it will definitely be played back-to-back).

Play will continue until the show is shut down (at a time determined by the [schedule](#)). If the sequences are to be played in the order listed, and the end of the list is reached before the show is to shut down, play will loop back to the first sequence in the list.

Optionally, a "cleanup sequence" can also be specified in the musical section. If so, that sequence will be played immediately after the completion of any sequence in the musical section, before the next one begins. Also optionally, a delay can be specified between songs.

You can control whether or not sequences in this section will automatically turn their lights off when they reach their end by setting the "Turn used lights off at the end of each sequence" checkbox.

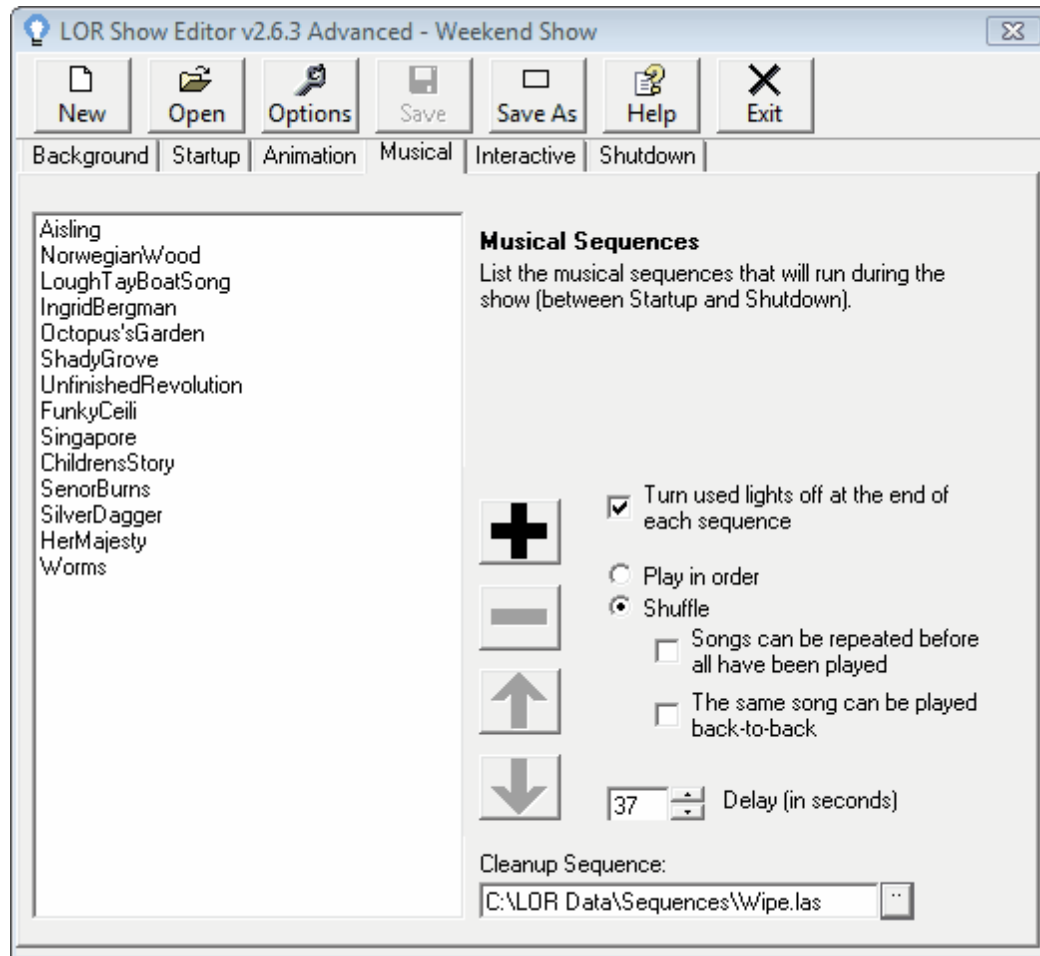

The musical section in the Show Editor, with several sequences, shuffled, with a delay and a cleanup sequence

The Interactive Section

Some [Light-O-Rama controllers](#) can be used not only to control lights, but also to accept input from people, causing Light-O-Rama to play [sequences](#) on demand. For example, you could have a big red button as part of your display, which, when pressed, will cause Light-O-Rama to start playing a particular song or songs.

This is controlled through the interactive section of the [show](#). You can use this tab in the [Show Editor](#) to specify what sequences are to be played when which inputs are triggered. Please see the separate page on [interactive groups](#) for details.

Note that, unlike for the other sections of the show, the Show Editor's "Interactive" tab actually lists groups of sequences, rather than directly listing sequences. Again, please see the page on [interactive groups](#) for details on how to create and modify these groups of sequences.

You can control whether or not sequences in this section will automatically turn their lights off when

they reach their end by setting the "Turn used lights off at the end of each sequence" checkbox, but unlike in other sections of the show, this setting is controlled individually for each interactive group, rather than for the section as a whole.

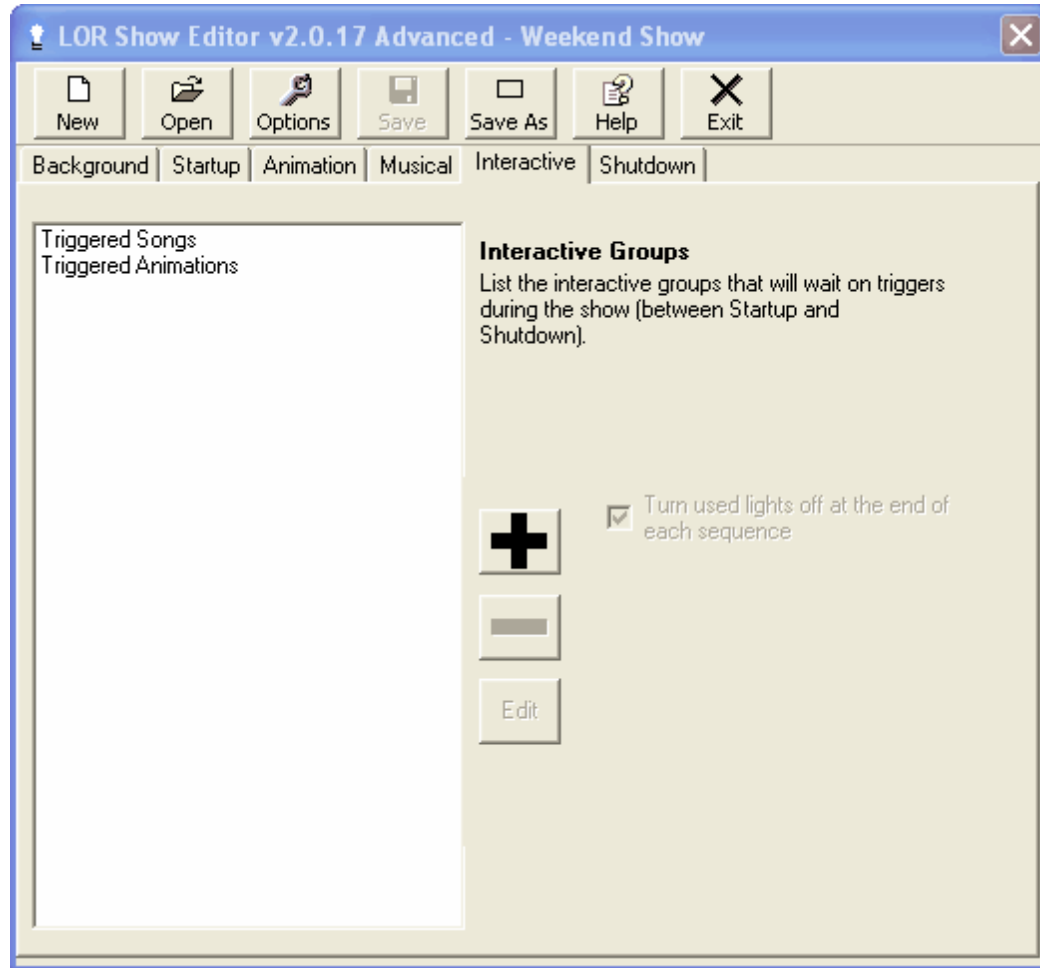

The interactive section in the Show Editor, with two groups of sequences

The Shutdown Section

When the end of a show is reached (at a time determined by the [schedule](#)), its [animation section](#) and [musical section](#) will end, and its shutdown section will begin. [Sequences](#) in the shutdown section will play, one at a time, in the order listed in the [Show Editor](#). After they all have completed, the show is truly finished.

You can control whether or not sequences in this section will automatically turn their lights off when they reach their end by setting the "Turn used lights off at the end of each sequence" checkbox.

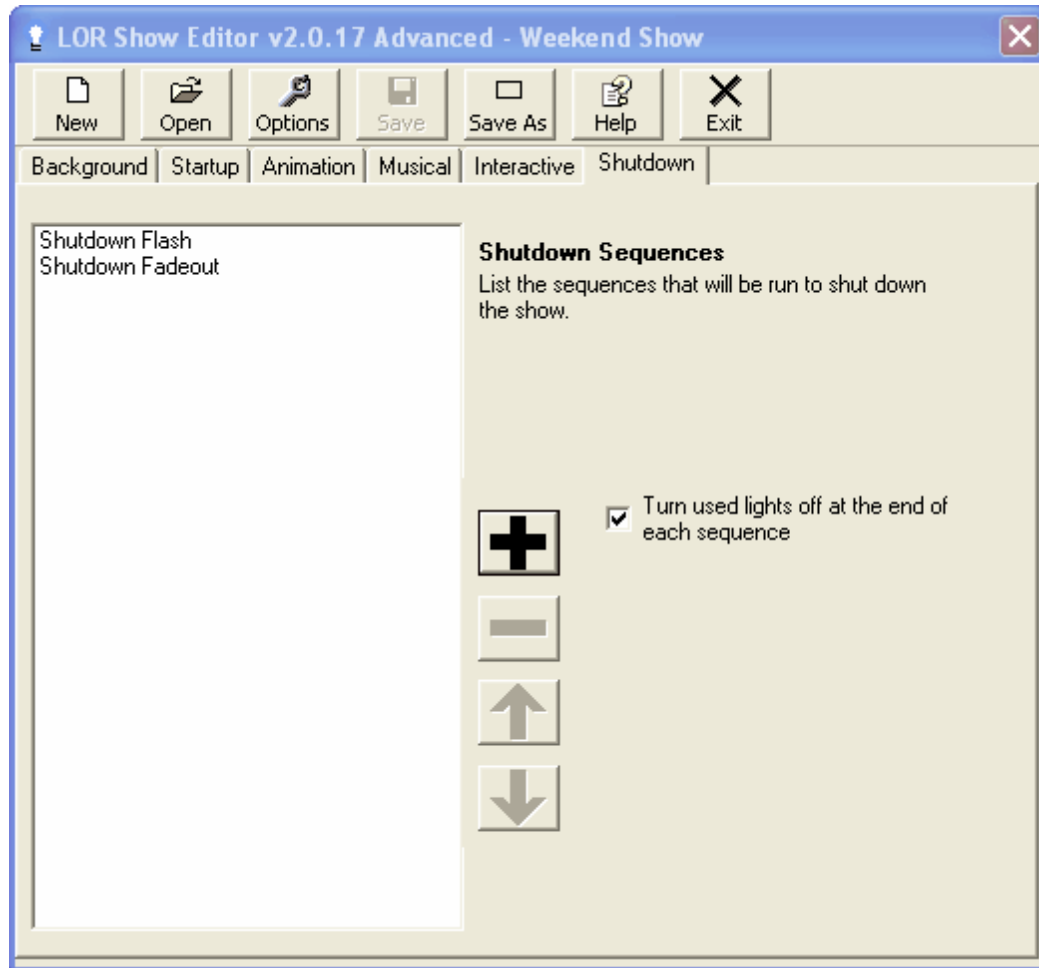

The shutdown section in the Show Editor, with two sequences

Show Startup Options

If your [Light-O-Rama software license](#) is for the Advanced feature level, you have more control over exactly how your [show](#) will start up:

- [Immediate startup](#)
- [Triggered startup](#)
- [Immediate background startup](#)

To choose which way you want your show to start, select the "Options" button at the top of the [Show Editor](#). This will bring up the following dialog, which has a "Startup Type" section where you can choose which way the show will start:

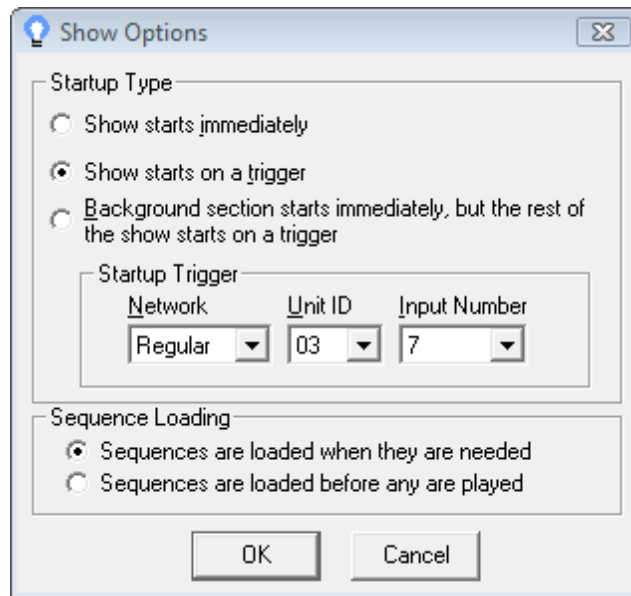

The Show Options dialog, with triggered startup selected

Immediate Startup

In immediate startup mode, your [show](#) will begin immediately at its [scheduled](#) start time.

This is equivalent to the same way that shows always started in earlier releases of Light-O-Rama.

Triggered Startup

In triggered startup mode, your [show](#) will start when a specified [circuit](#) on a specified [Light-O-Rama controller](#) is triggered (as long as it is triggered during the show's [scheduled](#) run time). For example, you could hook up a big red button labeled "Start the Show" to a controller.

Immediate Background Startup

In immediate background startup mode, your [show's Background section](#) will start immediately at the show's [scheduled](#) start time, but the rest of the show will not start until a specified [circuit](#) on a specified [Light-O-Rama controller](#) is triggered (as long as it is triggered during the show's scheduled run time).

Sequence Loading Options

By default, when a [show](#) is being played in the [Show Player](#), any given [sequence](#) in the show will not be loaded until when it is about to be played for the first time. Depending upon the size of the sequence and the power of the computer, it may take a human-noticeable amount of time to load a sequence; if so, this may cause an undesired delay between sequences, the first time they are played. So, optionally, you can choose to preload all sequences before any of them are played. To do so, click on the "Options" button in the [Show Editor's](#) toolbar, and then select "Sequences are loaded before any are played" from the "Sequence Loading" section of the options dialog:

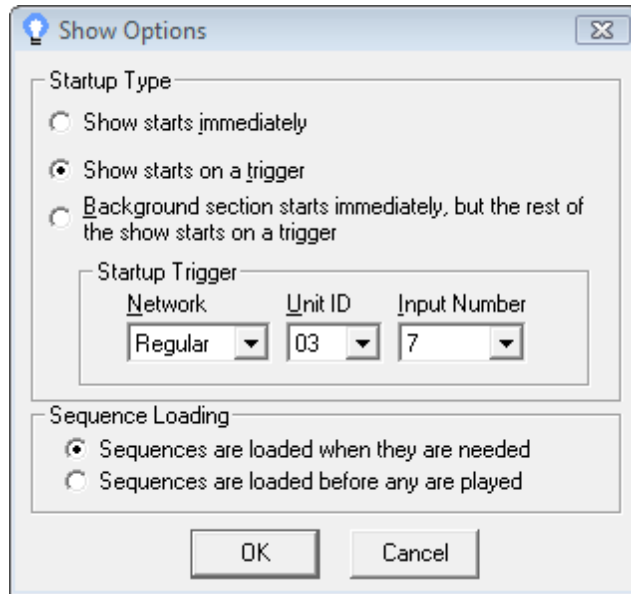

The Show Options dialog

4.2.1 Interactive Groups

Some [Light-O-Rama controllers](#) can be used not only to control lights, but also to accept input that can be used to trigger a [sequence](#) or sequences. For example, your display might have several buttons for people to press, each of which will cause Light-O-Rama to play some particular song on demand.

This is controlled through the [Interactive Section](#) of a [show](#). Unlike the other sections of a show, the [Show Editor's](#) "Interactive" tab displays not sequences, but groups of sequences, known as "interactive groups". Each group matches individual [circuits](#) on individual controllers with individual sequences to be played when those circuits are triggered.

Only one [musical sequence](#) can be playing at any given time. Therefore, if a musical sequence from an interactive group is triggered, any musical sequence that happens to already be playing will be stopped (for one exception to this, see the "[Jukebox](#)" type of interactive group, below).

- [Types of Interactive Groups](#)
 - [Jukebox](#)
 - [Soundboard](#)
 - [Magic Toy](#)
- [Choosing Sequences for a Group](#)

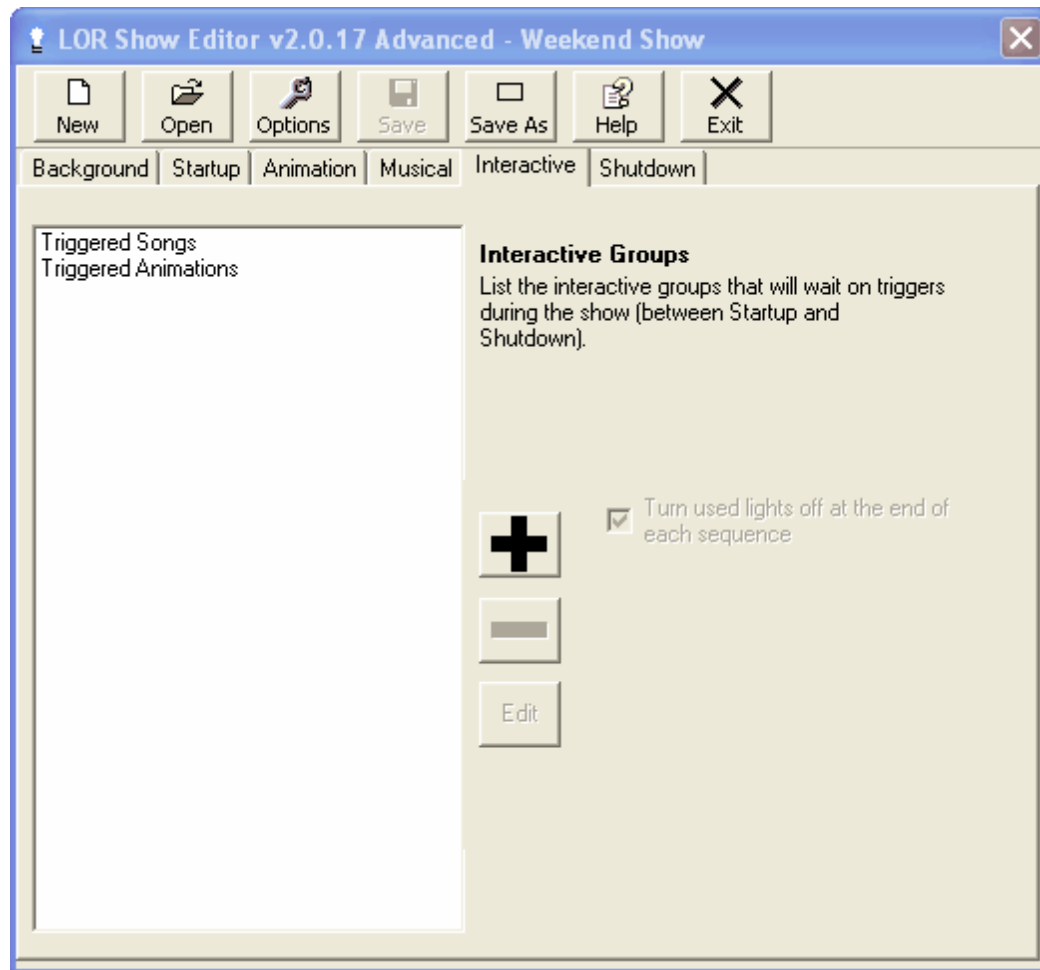

The Show Editor's Interactive tab

Types of Interactive Groups

When you click the large "+" button, to add a new [interactive group](#) to the [show](#), you will then be prompted to choose the type of interactive group to add:

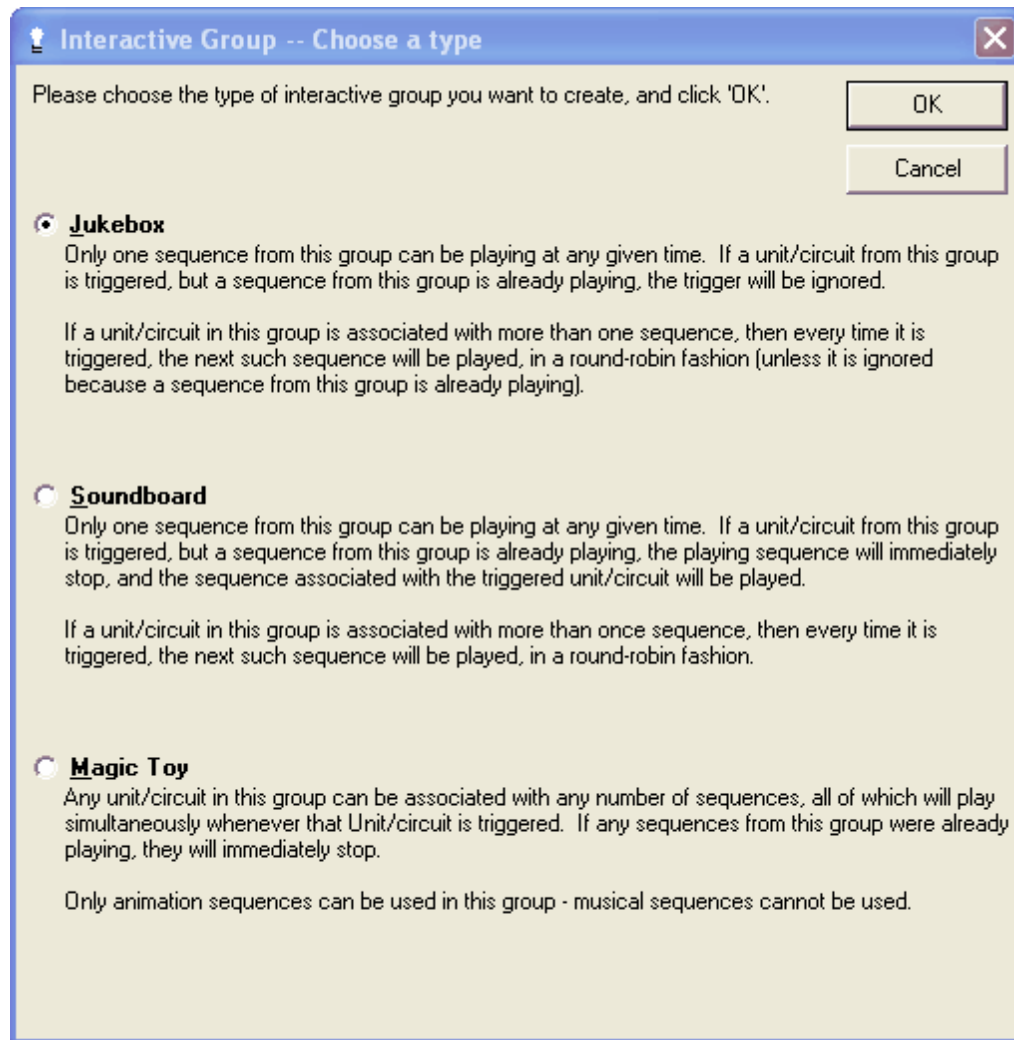

Choosing the type of a new interactive group

There are three types of interactive groups:

- [Jukebox](#)
- [Soundboard](#)
- [Magic Toy](#)

After choosing which type of interactive group you want, you will be given a [choice of which sequences to put in the group](#).

Jukebox

"Jukebox" [interactive groups](#) allow you to define a group of [sequences](#), each hooked up to be triggered by an individual [circuit](#) on some [LOR controller](#), such that only one sequence in the group can be playing at any given time, and if one already is playing when another is triggered, the first will continue playing uninterrupted, and the trigger will be ignored.

If you assign more than one sequence to a single circuit in a single jukebox, then whenever that circuit is triggered, the "next" sequence in the list, round-robin, will be played.

Both [musical sequences](#) and [animation sequences](#) can be placed into a jukebox interactive group.

Soundboard

"Soundboard" [interactive groups](#) are similar to [jukebox](#) interactive groups in that only one [sequence](#) in the group can be playing at any given time. However, unlike jukebox interactive groups, triggering a sequence while another sequence from the group is currently playing will cause the playing sequence to stop, and the triggered sequence to start.

If you assign more than one sequence to a single circuit in a single soundboard, then whenever that circuit is triggered, the "next" sequence in the list, round-robin, will be played.

Both [musical sequences](#) and [animation sequences](#) can be placed into a soundboard interactive group.

Magic Toy

"Magic toy" [interactive groups](#) allow you to set up a group of [sequences](#) such that many of them can be started simultaneously by a single trigger. Any sequences already playing from the group will be stopped when the new set is started.

Only [animation sequences](#) (as opposed to [musical sequences](#)) can be placed into a magic toy interactive group.

Choosing Sequences for a Group

After you choose the [type](#) of your new [interactive group](#), or upon editing an existing group, you will be shown a list of the triggers for the group:

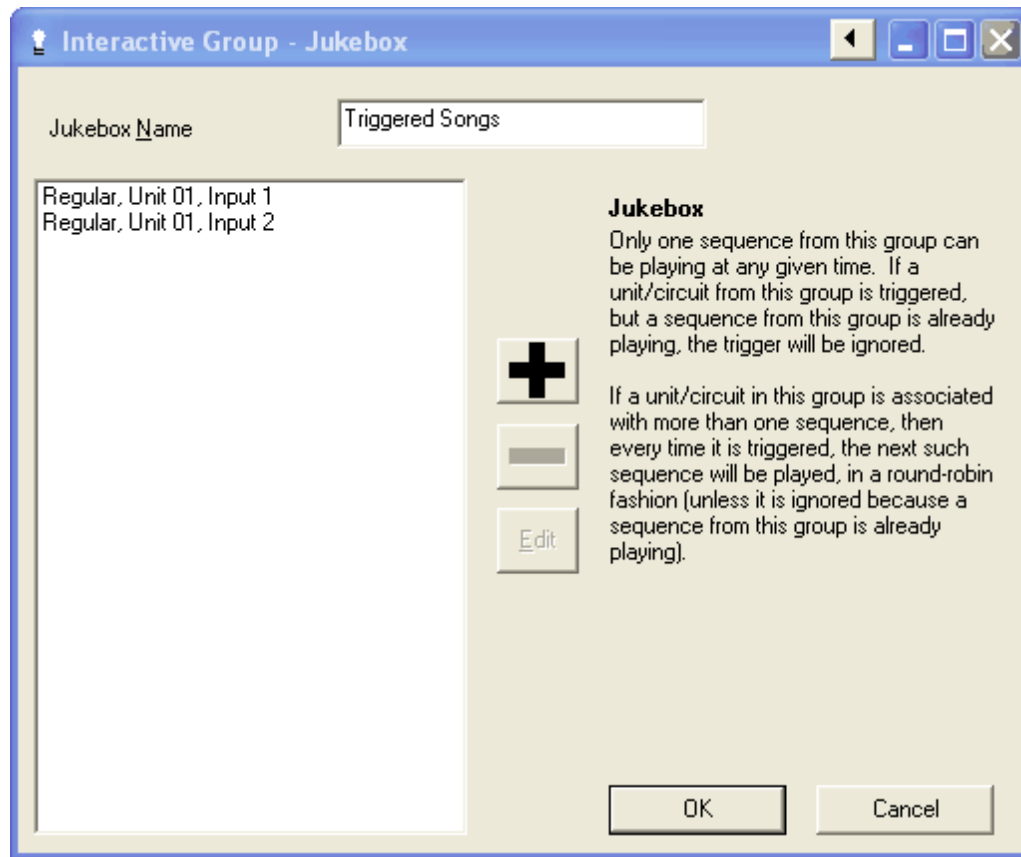

The triggers in an interactive group

When you add a new trigger to this list (by clicking the large "+" button) or edit an existing trigger, you will be given a choice of which sequences are assigned to the trigger, and which [circuit](#) on which [unit](#) of which [network](#) triggers them. You can also assign a name to the trigger:

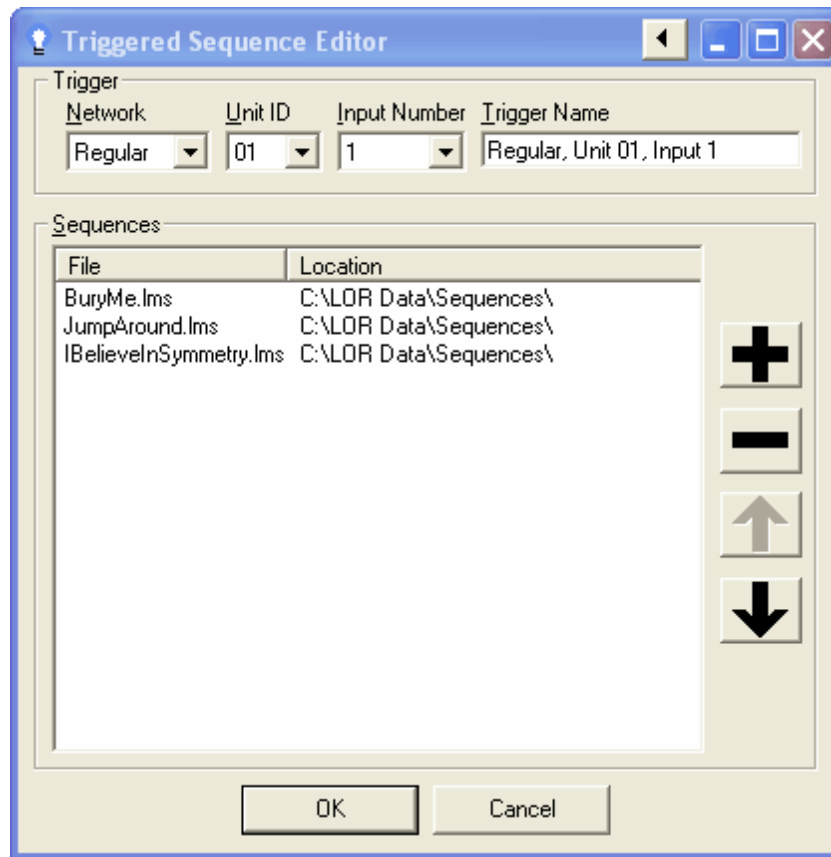

Choosing the sequences assigned to a trigger in an interactive group

4.3 Schedules

What Is a Schedule?

The schedule is at the top of the Light-O-Rama [schedule/show/sequence hierarchy](#):

- The schedule is created and modified by the [Light-O-Rama Schedule Editor](#), and played by the [Light-O-Rama Show Player](#).
- It consists of [shows](#), which are created and modified by the [Light-O-Rama Show Editor](#). The schedule schedules these shows to be played at certain times.
- Shows consist of [sequences](#), which are created and modified by the [Light-O-Rama Sequence Editor](#).
- Sequences are composed of commands to be sent to your lights, producing various [lighting effects](#).

The schedule has two parts: the [weekly schedule](#) and the [calendar schedule](#). The weekly schedule contains information on shows that should be played on a recurring, weekly basis - for example, every Wednesday night from 7:00 PM to 10:00 PM. The calendar schedule contains information on shows that should be played once, at a specific date and time.

When the [Light-O-Rama Show Player](#) looks at the schedule to decide whether a show should be played, it first checks the calendar schedule to see if it has any shows scheduled for the current date and time. If there are, the Show Player will play that show. Otherwise, the Show Player will

check the weekly schedule.

Example

Suppose you have a single show which you want to play every Friday and Saturday night, from 7:00 PM to 10:00 PM, except for Christmas Eve (when you want it to run from 5:00 PM to 11:00 PM) and Christmas Day (when you want it to run from 8:00 AM to 2:00 PM). Then you would put the Friday and Saturday shows into the [weekly schedule](#), and the Christmas Eve and Christmas Day shows in the [calendar schedule](#). The Light-O-Rama Show Player would then follow the weekly schedule on every day except Christmas Eve and Christmas Day, when it would then follow the calendar schedule.

Considerations

- Unlike the [Show Editor](#), which can be used to create many [shows](#), and the [Sequence Editor](#), which can be used to create many [sequences](#), the [Schedule Editor](#) only maintains a single schedule, and the [Show Player](#) only uses that single schedule.
- The [Show Player](#) will not play any scheduled [shows](#) unless it is started and scheduled shows are enabled, via "[Enable Schedule](#)" in the [Light-O-Rama Control Panel](#).
- After modifying your schedule in the [Schedule Editor](#), make sure to save it. Changes to your schedule will not be picked up by the [Show Player](#) until the schedule has been changed.

4.3.1 The Weekly Schedule

The weekly schedule is part of the [schedule](#), saying which shows should be played when. The other part of the schedule is the [calendar schedule](#).

The difference between these two parts of the schedule is that the weekly schedule allows you to specify shows that should be played by the [Light-O-Rama Show Player](#) on a recurring, weekly basis, while the calendar schedule allows you to specify shows that should be played by the Show Player once, at a specific date and time. For example, the weekly schedule would be used to have a show run every Thursday between 5:00 PM and 10:00 PM, while the calendar schedule would be used to have a show playing specifically on Christmas Eve.

Both parts of the schedule are created and modified using the [Light-O-Rama Schedule Editor](#), and shows in them are played at the scheduled times by the [Light-O-Rama Show Player](#) (assuming that "[Enable Schedule](#)" has been turned on in the [Light-O-Rama Control Panel](#)). The Show Player, when deciding whether a show should be played, will first check the calendar schedule, and only play a show from the weekly schedule if none is scheduled for the current date and time in the calendar schedule.

The following picture shows the weekly schedule, as displayed in the Schedule Editor, with two different shows scheduled:

- "Weekday Show.Iss", run Mondays to Thursdays from 5:00 PM to 9:00 PM, and Fridays 5:00 PM to 11:00 PM;
- "Weekends.Iss", run Saturdays from 1:00 PM to 11:00 PM, and Sundays from 1:00 PM to 9:00 PM.

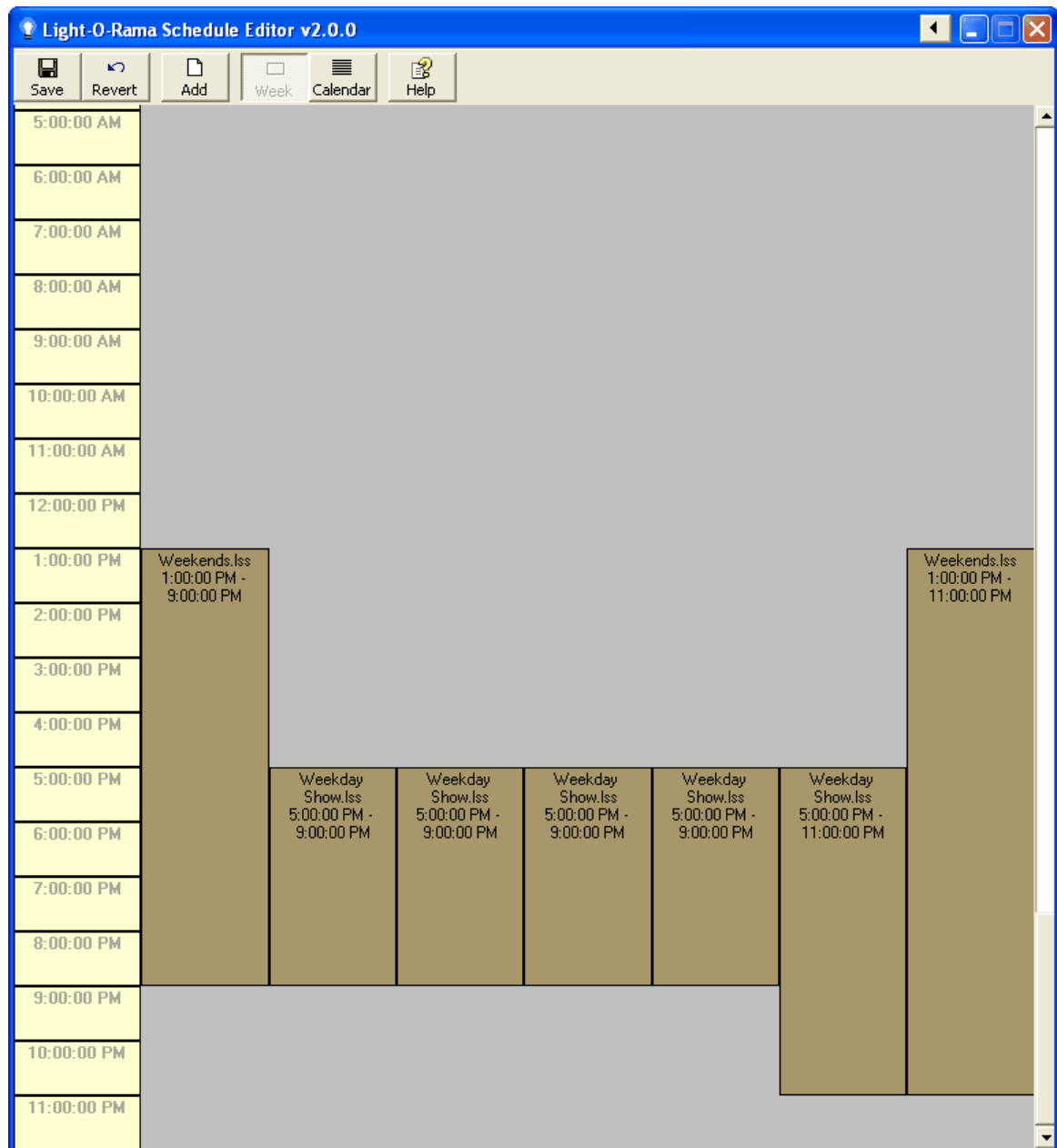

The weekly schedule, as displayed in the Schedule Editor, with some scheduled shows

For details on creating and modifying the weekly schedule, please see the [Schedule Editor](#).

4.3.2 The Calendar Schedule

The calendar schedule is part of the [schedule](#), saying which shows should be played when. The other part of the schedule is the [weekly schedule](#).

The difference between these two parts of the schedule is that the weekly schedule allows you to specify shows that should be played by the [Light-O-Rama Show Player](#) on a recurring, weekly basis, while the calendar schedule allows you to specify shows that should be played by the Show Player once, at a specific date and time. For example, the weekly schedule would be used to have a show run every Thursday between 5:00 PM and 10:00 PM, while the calendar schedule would be used to have a

show playing specifically on Christmas Eve.

Both parts of the schedule are created and modified using the [Light-O-Rama Schedule Editor](#), and shows in them are played at the scheduled times by the [Light-O-Rama Show Player](#) (assuming that "[Enable Schedule](#)" has been turned on in the [Light-O-Rama Control Panel](#)). The Show Player, when deciding whether a show should be played, will first check the calendar schedule, and only play a show from the weekly schedule if none is scheduled for the current date and time in the calendar schedule.

The following picture shows the calendar schedule, with a show named "Christmas Eve.Iss" scheduled to be run on December 24, 2007 from 5:00 PM to 11:00 PM:

The screenshot displays the 'Light-O-Rama Schedule Editor v2.0.0' window. The interface features a menu bar with 'Save', 'Revert', 'Add', 'Week', 'Calendar', and 'Help' options. Below the menu bar, there are four calendar views: November 2007, December 2007, January 2008, and February 2008. The December 2007 calendar shows the 24th highlighted. A red circle highlights the text 'Today: 10/25/2007'. On the right side, there is a vertical timeline from 5:00:00 AM to 11:00:00 PM. A dark brown block is visible in the timeline between 5:00:00 PM and 11:00:00 PM on December 24th, labeled 'Christmas Eve.Iss 5:00:00 PM - 11:00:00 PM'.

The calendar schedule, displayed in the Schedule Editor, with a show scheduled on December 24 at 5:00 PM

For details on creating and modifying the calendar schedule, please see the [Schedule Editor](#).

4.4 Hardware

Light-O-Rama can control your lights via several different kinds of hardware controllers. Primary among these, of course, are Light-O-Rama controllers, but all of the following types of controllers can be used:

- [Light-O-Rama controllers](#)
- [Native DMX devices](#)
- [Dasher controllers](#)
- [Digital IO cards](#)
- [BSOFT digital IO cards](#)
- [X10 controllers](#)

Most [lighting effects](#) (such as [fading](#), [twinkling](#), and [shimmering](#)) are only supported on Light-O-Rama controllers and native DMX devices. Other controllers can only be turned on (to full brightness) or off.

When a [channel](#) is created in a [sequence](#) using the [Sequence Editor](#), the kind of controller (known as "device type") can be assigned to it in a couple of ways:

- In the [Channel Settings dialog](#), accessible by left-clicking the [channel's button](#) or by selecting "[Change Channel Settings](#)" on the [channel's right-click popup menu](#);
- Via the [Channel Configuration screen](#), accessible by selecting "[Channel Configuration](#)" in the [Tools menu](#).

The Channel Settings dialog is most useful for changing a single channel, while the Channel Configuration screen is more useful for changing many channels at once.

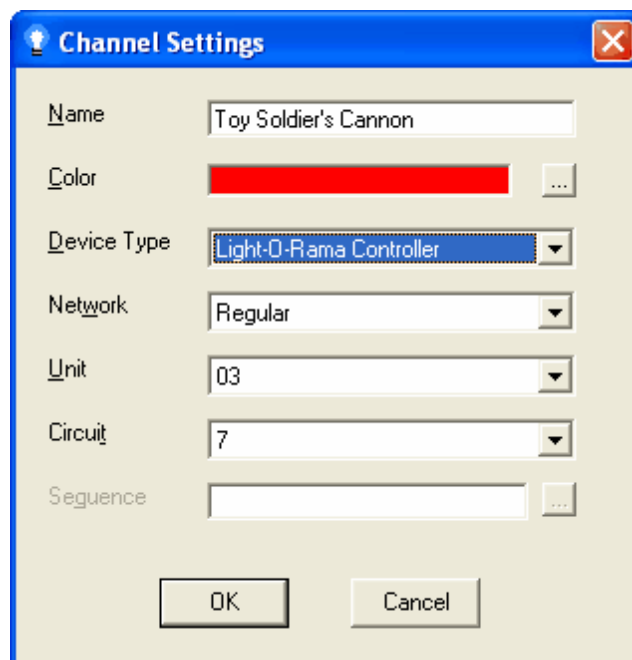

The Channel Settings dialog

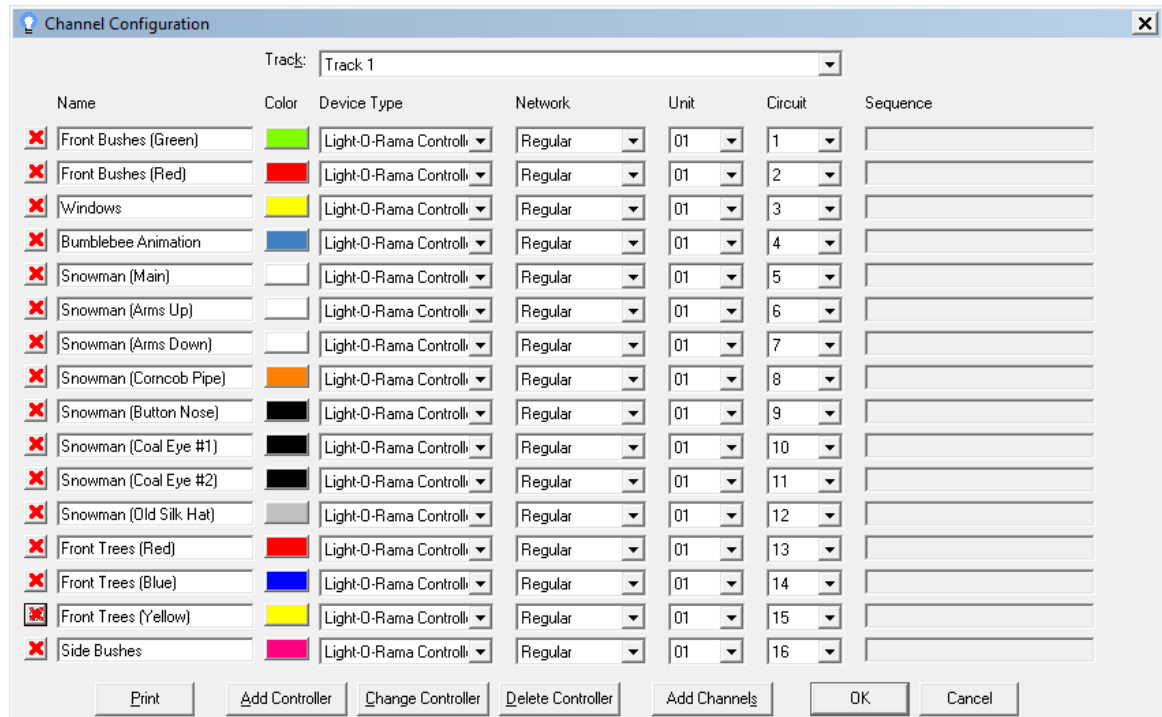

The Channel Configuration screen

4.4.1 Light-O-Rama Controllers

Light-O-Rama allows your computer to control your lights via a variety of hardware controllers. Primary among these are Light-O-Rama controllers. [Other kinds of controllers](#) can be used, but most [lighting effects](#) (such as [fading](#) and [twinkling](#)) are only supported on Light-O-Rama controllers.

Some Light-O-Rama controllers can also act as [input triggers](#), allowing you to start particular [sequences](#) on demand (such as when a person pushes a button).

Unit IDs

Each Light-O-Rama controller is assigned a unit ID. A unit ID is an identifier for the controller, and is two characters long, with each character being a digit (0-9) or a letter from A to F. For example, 37, 25, 4B, C8, and DA are all valid unit IDs. Some such combinations are reserved, though, and should not be used for as a unit ID. Specifically, 00, F1 through F9, and FA through FF are not valid unit IDs.

Controllers will only react to lighting commands that are intended for their own unit ID; if two controllers on the same [network](#) have the same unit ID, both will react simultaneously to the same commands. However, a unit set up to use [input triggers](#) must have its own unique unit ID, not shared with any other unit. Also, the [Hardware Utility](#) may react strangely with respect to a unit ID which has more than one unit - for example, detecting them as a single unit, or misdetecting them as some unknown controller type.

The unit ID of a controller is set in one of two ways, depending upon the type of controller:

- Most controllers have physical switches on them that allow you to set the unit ID by moving the switches.

- Otherwise, the Hardware Utility can be used to select a unit ID for controllers without such switches.

It is generally a good habit to assign your unit IDs sequentially starting at 01. This is not necessary, but it will speed up some maintenance such as configuring and testing your controllers in the [Hardware Utility](#).

Circuit IDs

Within a controller, each string of lights is assigned a specific circuit ID. This allows Light-O-Rama to make different lights do different effects at the same time, using the same controller.

Standalone Mode and Computer Controlled Mode

Light-O-Rama controllers can be set up in standalone mode, in which a [sequence](#) is downloaded to them in advance via the [Hardware Utility](#), or hooked up to your computer via a COM port, in which case the [Light-O-Rama Show Player](#) will send them lighting commands (during [scheduled shows](#)), or the [Light-O-Rama Sequence Editor](#) will (on demand for a single sequence).

A controller in standalone mode can also send lighting commands to other controllers that are hooked up to it via phone lines or data lines, similarly to the way that the Show Player or Sequence Editor would. Therefore, in standalone mode, a sequence only needs to be downloaded (via the Hardware Utility) to a single controller; the other controllers hooked up to it will receive their commands from it.

Only one source of lighting commands should be present in any group of controllers that are hooked up to each other - either the Show Player, the Sequence Editor, or a single controller with a downloaded sequence. Having more than one source of commands will cause unexpected and undesired results, as lighting commands will be missed or garbled.

Light-O-Rama Networks

The [Show Player](#) and [Sequence Editor](#) can control up to sixteen different networks of Light-O-Rama controllers, each hooked up over a different COM port. These networks are referred to as "Regular" (which is the default), "Aux A", "Aux B", "Aux C", and so on, up to "Aux O".

One main use of multiple networks is for displays with very large numbers of controllers; they enable more lighting commands to be sent out at a single time. They also allow you to set up a sort of star network centered on your PC, rather than a single long daisy chain of controllers; both of these may make such sequences perform more smoothly.

Another use is for displays whose controllers are hooked up using wireless communications, via a Light-O-Rama Easy Light Linker. Wireless communications has a lower top speed than wired, but using multiple wireless networks allows commands to be sent over all of them simultaneously. So, depending upon how many controllers you have and how many lighting effects you send them during your show, using multiple wireless networks could make your show perform more smoothly than using a single wireless network.

It is simplest, though, to just use a single Light-O-Rama network, and in many situations, this is perfectly sufficient.

The COM ports represented by each of the networks can be set via the [Network Preferences dialog](#) of the [Edit menu](#) of the Sequence Editor. For example, the following picture shows COM6 assigned to the Regular network, COM7 to Aux A, COM8 to Aux B, and leaves the remaining networks with no COM port assigned:

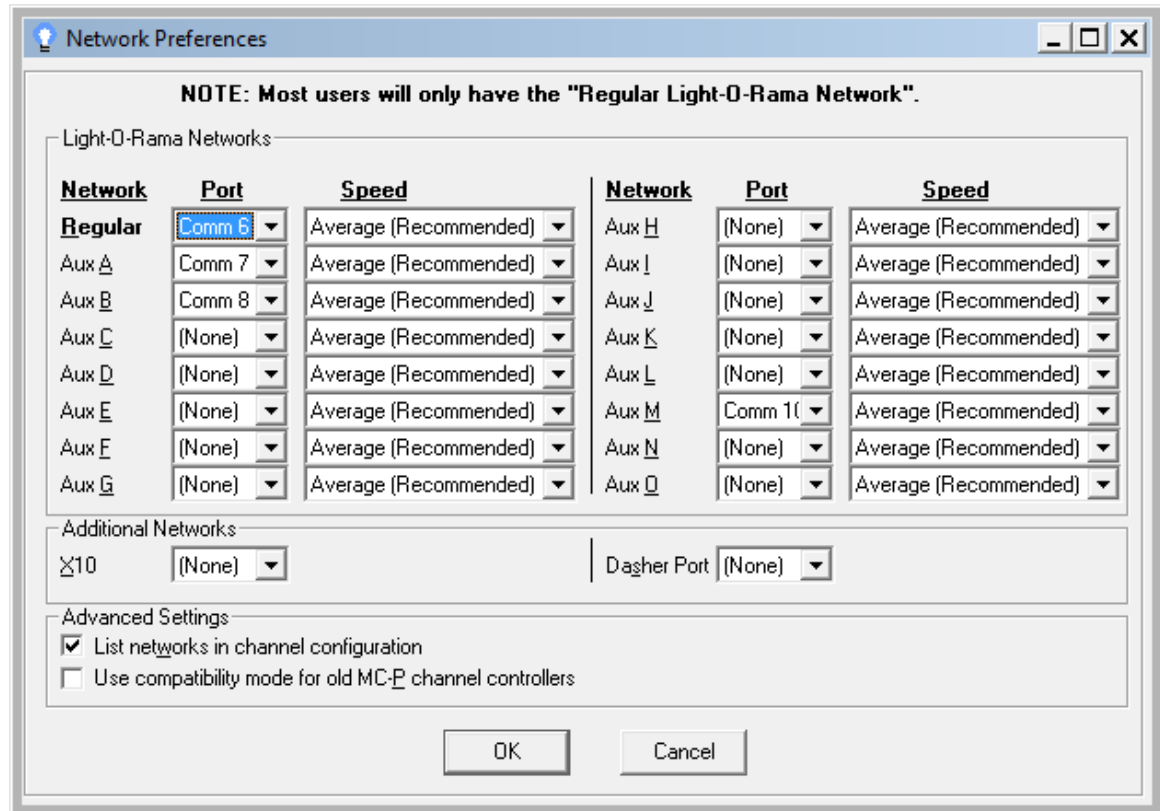

Multiple COM ports assigned to various Light-O-Rama networks

Assigning Circuits to Channels

When a [sequence](#) is created using the [Sequence Editor](#), each of its [channels](#) can be assigned a string of lights using the [Channel Settings dialog](#) or the [Channel Configuration screen](#) (the former may be more convenient for modifying a single channel, and the latter for modifying multiple channels at once).

For Light-O-Rama controllers, these allow you to set the [network](#), [unit ID](#), and [circuit ID](#) assigned to the channel. Without these being assigned for a channel, any [lighting effects](#) made for that channel will not happen on your actual lights.

For example, the following Channel Settings dialog shows a channel for a Light-O-Rama controller on the regular network, with unit ID 03 and Circuit ID 7:

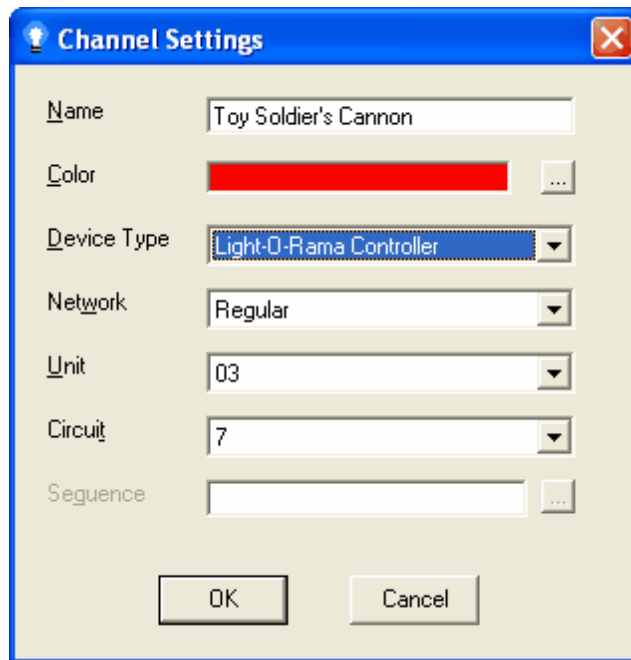

The Channel Settings dialog for a Light-O-Rama controller

The Channel Settings dialog can be accessed by left-clicking on the [channel's button](#), or by selecting "[Change Channel Settings](#)" from the [channel button's right-click popup menu](#). The Channel Configuration screen can be accessed by selecting "[Channel Configuration](#)" from the [Tools menu](#).

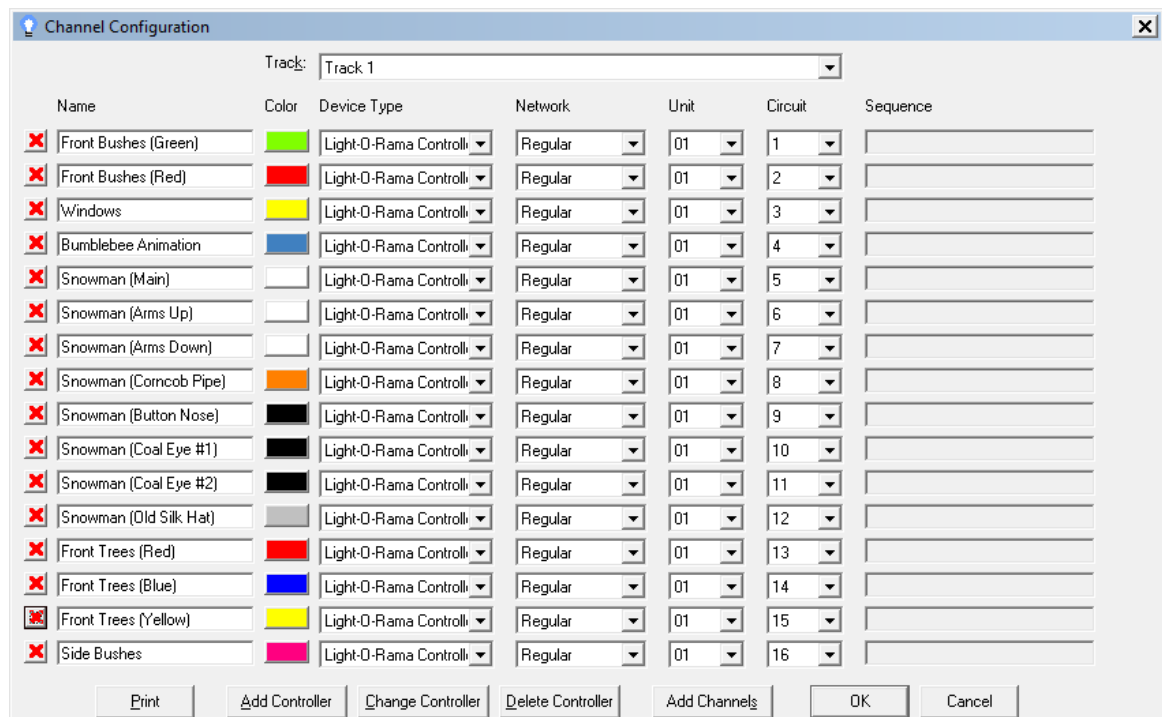

The Channel Configuration screen

4.4.2 Native DMX Devices

In addition to [Light-O-Rama controllers](#) and [various other types of controllers](#), Light-O-Rama can control native DMX devices.

To set a [channel](#) to use DMX protocol, set its device type to "DMX Universe". You can then set its universe and address (similarly to setting up an LOR controller's [network](#), [unit](#), and [circuit](#)). This can be done in the [Sequence Editor's Channel Configuration Screen](#) or in the channel's [Channel Settings dialog](#).

Up to sixteen DMX universes can be used. Each should be assigned a separate DMX adapter (such as an ENTTEC Open DMX USB adapter). You can assign adapters to universes via the Sequence Editor's [Network Preferences dialog](#).

Unlike other protocols (such as LOR or [X10](#)), the DMX protocol requires that the [LOR Control Panel](#) be running in order to actually control the devices. The LOR Control Panel will, in turn, start up the [LOR Comm Listener](#). When a program such as the Sequence Editor or [Show Player](#) wants to send a command to a DMX device, it actually sends the command to the LOR Comm Listener, which in turn sends it out over the adapter assigned to the device's specified universe.

Note that you do *not* have to use the "[DMX Intensity](#)" [effect](#) on DMX channels. You can, but you can also use any other effect (such as [Fade Up](#) or [Twinkle](#)). If you use a DMX Intensity effect, it will have a natural DMX intensity range of 0 to 255. If you use any other effect, it will have a range of 0 to 100, but Light-O-Rama will automatically scale it to DMX's 0 to 255 range immediately before sending it out to the actual DMX device.

4.4.3 Dasher Controllers

In addition to [Light-O-Rama controllers](#) and [various other types of controllers](#), Light-O-Rama can control your lights that are hooked up to Dasher controllers.

Limitations of Dasher Controllers

Not all of Light-O-Rama's [lighting effects](#) are supported on Dasher controllers; to use effects other than "[on](#)" or "[off](#)" (such as [twinkling](#), [shimmering](#), [fading](#), and [brightness intensities](#) other than "totally off" or "full brightness"), you must use [Light-O-Rama controllers](#).

The Dasher Port

All Dasher controllers that you will use must be hooked up to your computer over a single COM port, known as the Dasher Port. You can select which COM port is the Dasher port in the "Additional Networks" section of the [Network Preferences dialog](#) of the [Edit menu](#) of the [Sequence Editor](#):

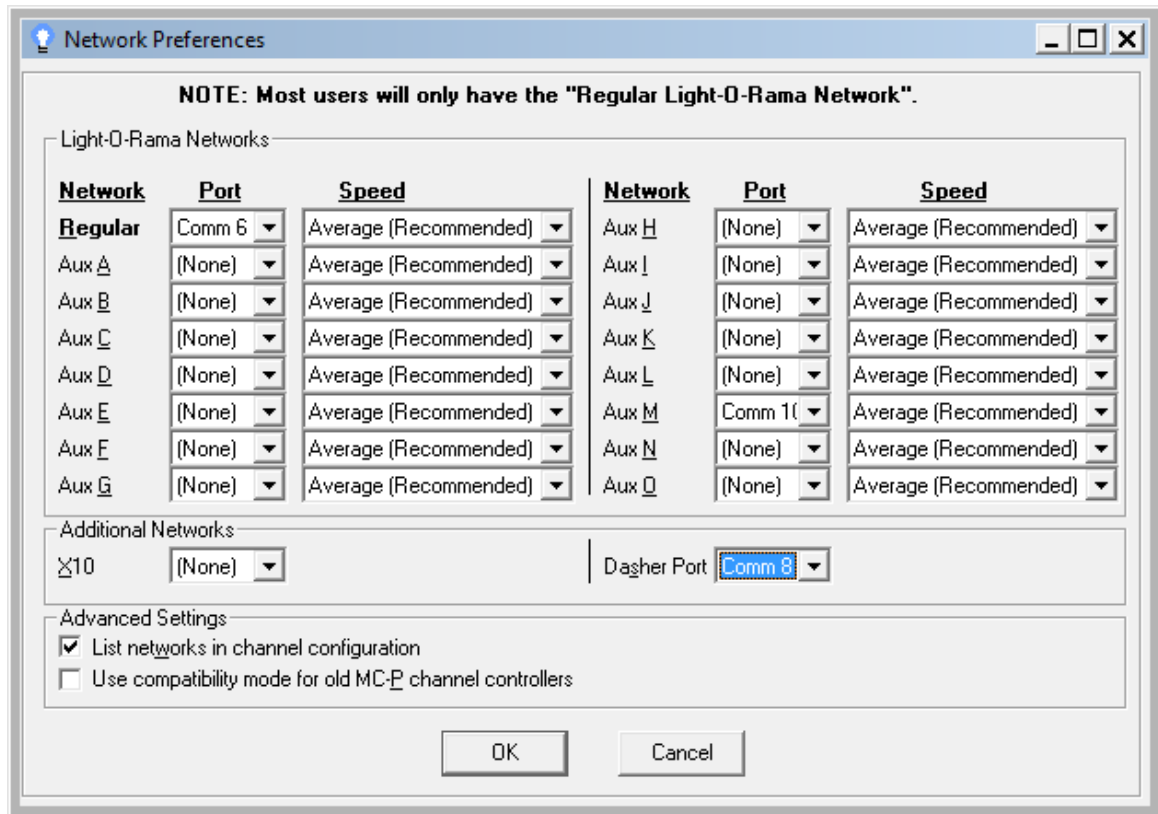

The Network Preferences dialog, with the Dasher Port set to COM8

Unit IDs

Each Dasher controller has a unit ID, identifying which controller it is. A controller will only react to lighting commands for its unit ID. For a Dasher controller, the unit ID is a number between 1 and 106.

Circuit IDs

Each Dasher controller has eight circuits, each of which can control independent strings of lights. A circuit is on a Dasher controller identified by a circuit ID between 1 and 8.

Assigning Circuits to Channels

When a [sequence](#) is created using the [Sequence Editor](#), each of its [channels](#) can be assigned a string of lights using the [Channel Settings dialog](#) or the [Channel Configuration screen](#) (the former may be more convenient for modifying a single channel, and the latter for modifying multiple channels at once).

For a Dasher controller, these allow you to set the [unit ID](#) and [circuit ID](#) assigned to a channel. Without these being set, controllers will not react to lighting effects that you have put into your sequence.

For example, the following shows the Channel Settings dialog for a channel assigned to circuit 7 of a Dasher controller with unit ID 37:

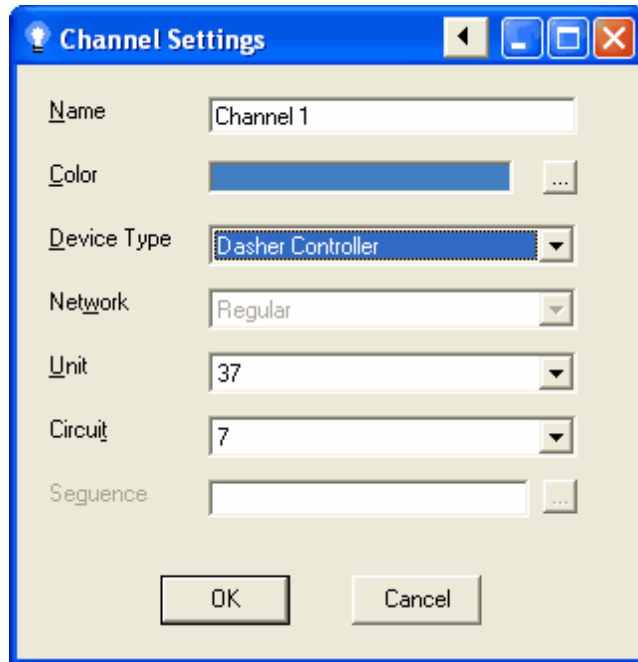

Channel Settings for a Dasher controller

The Channel Settings dialog can be accessed by left-clicking on the [channel's button](#), or by selecting "[Change Channel Settings](#)" from the [channel button's right-click popup menu](#). The Channel Configuration screen can be accessed by selecting "[Channel Configuration](#)" from the [Tools menu](#).

Importing Dasher Files

In addition to being able to use Dasher controllers, Light-O-Rama can also import sequences created using the Dasher program, and convert them to [Light-O-Rama sequences](#) that can be used in your [shows](#).

To convert a Dasher sequence to a Light-O-Rama sequence, simply open the Dasher sequence using the [Sequence Editor](#) (for example, via "[Open](#)" of the [File menu](#)). Light-O-Rama will detect that it is a Dasher sequence, and prompt you on how to import it:

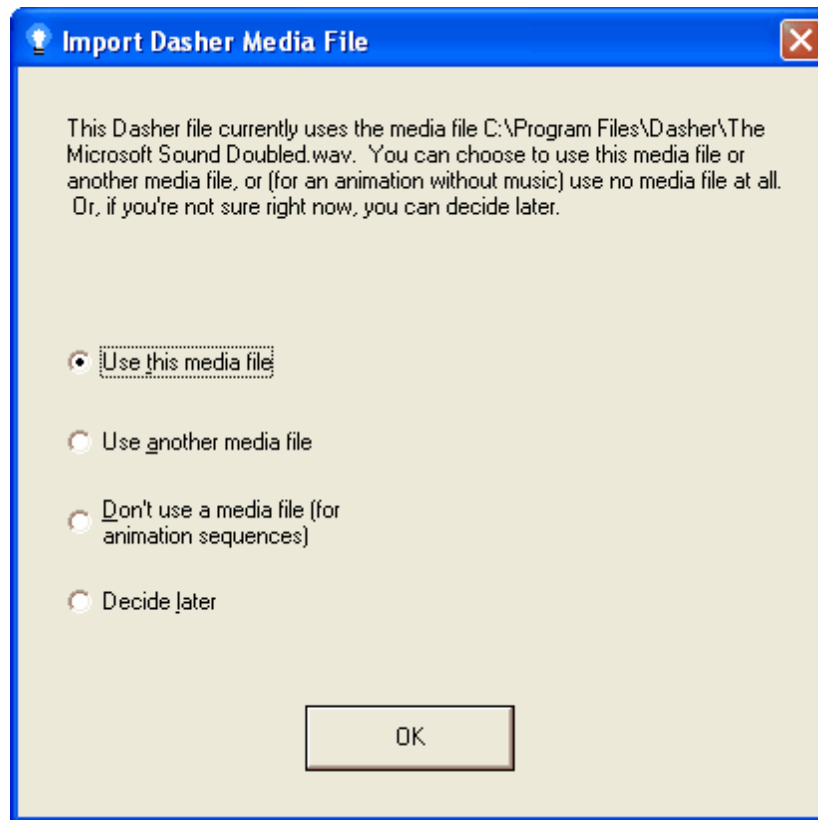

The Dasher Import dialog

The reason for this dialog is one of the differences between Light-O-Rama and the Dasher program: Dasher sequences must always be associated with an audio file, even if you don't want any sound to play while the sequence is controlling the lights. Often, people who used Dasher but did not want sound during a particular sequence would therefore create audio files that had no sound in them.

Light-O-Rama, on the other hand, has no need for such "empty" audio files. A Light-O-Rama [musical sequence](#) is associated with an audio (or video) file, and a Light-O-Rama [animation sequence](#) is not.

When you ask Light-O-Rama to import a file that was created using Dasher, it does not know whether the audio file used by the Dasher sequence is "empty" or not. If it is, then Light-O-Rama has no need for the audio file. So, the Sequence Editor displays this dialog asking you whether it really needs this audio file or not.

Finally, after importing a Dasher sequence, make sure to save it. It will be saved as a Light-O-Rama sequence. Only the new Light-O-Rama sequence can be used in your [shows](#); the old Dasher sequence that it was imported from cannot.

4.4.4 Digital IO Cards

In addition to [Light-O-Rama controllers](#) and [various other types of controllers](#), Light-O-Rama can control your lights that are hooked up to digital IO cards.

Note: This page does not apply to BSOFT digital IO cards. Light-O-Rama can control BSOFT digital IO cards, but if your digital IO card is a BSOFT digital IO card, please see the [separate help file page for such cards](#).

Requirements

In order to use digital IO cards with Light-O-Rama, your computer must have the [Universal Library and the InstaCal program](#).

Limitations of Digital IO Cards

Not all of Light-O-Rama's [lighting effects](#) are supported on digital IO cards; to use effects other than "on" or "off" (such as [twinkling](#), [shimmering](#), [fading](#), and [brightness intensities](#) other than "totally off" or "full brightness"), you must use [Light-O-Rama controllers](#).

Unit IDs

Each digital IO card has a unit ID, identifying which controller it is. A controller will only react to lighting commands for its unit ID. For a digital IO card, the unit ID is a number between 0 and 99.

Circuit IDs

Each digital IO card can control multiple strings of lights independently. To identify each such string, it is assigned a circuit ID between 0 and 191.

Assigning Circuits to Channels

When a [sequence](#) is created using the [Sequence Editor](#), each of its [channels](#) can be assigned a string of lights using the [Channel Settings dialog](#) or the [Channel Configuration screen](#) (the former may be more convenient for modifying a single channel, and the latter for modifying multiple channels at once).

For a digital IO card, these allow you to set the [unit ID](#) and [circuit ID](#) assigned to a channel. Without these being set, controllers will not react to lighting effects that you have put into your sequence.

For example, the following shows the Channel Settings dialog for a channel assigned to circuit 3 of a digital IO card with unit ID 37:

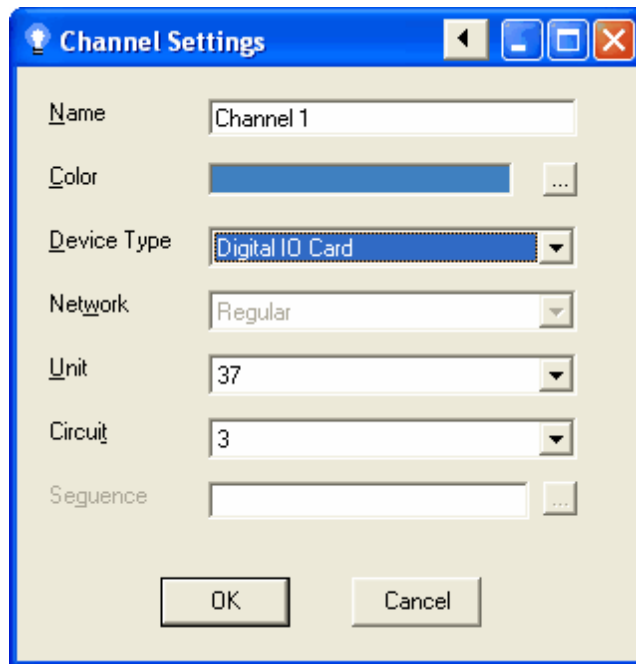

The Channel Settings dialog for a digital IO card

The Channel Settings dialog can be accessed by left-clicking on the [channel's button](#), or by selecting "[Change Channel Settings](#)" from the [channel button's right-click popup menu](#). The Channel Configuration screen can be accessed by selecting "[Channel Configuration](#)" from the [Tools menu](#).

4.4.5 BSOFT Digital IO Cards

In addition to [Light-O-Rama controllers](#) and [various other types of controllers](#), Light-O-Rama can control your lights that are hooked up to BSOFT digital IO cards.

Note: This page does not apply to any digital IO cards except BSOFT digital IO cards. Light-O-Rama can control other digital IO cards, but if your digital IO card is not a BSOFT digital IO card, please see the [separate help file page for such cards](#).

Requirements

In order to use BSOFT digital IO cards with Light-O-Rama, your computer must have the [Universal Library and the InstaCal program](#).

Limitations of BSOFT Digital IO Cards

Not all of Light-O-Rama's [lighting effects](#) are supported on BSOFT digital IO cards; to use effects other than "[on](#)" or "[off](#)" (such as [twinkling](#), [shimmering](#), [fading](#), and [brightness intensities](#) other than "totally off" or "full brightness"), you must use [Light-O-Rama controllers](#).

Unit IDs

Each BSOFT digital IO card has a unit ID, identifying which controller it is. A controller will only react to lighting commands for its unit ID. For a BSOFT digital IO card, the unit ID is a number between 0 and 99.

Circuit IDs

Each BSOFT digital IO card can control multiple strings of lights independently. To identify each such string, it is assigned a circuit ID between 0 and 95.

Assigning Circuits to Channels

When a [sequence](#) is created using the [Sequence Editor](#), each of its [channels](#) can be assigned a string of lights using the [Channel Settings dialog](#) or the [Channel Configuration screen](#) (the former may be more convenient for modifying a single channel, and the latter for modifying multiple channels at once).

For a BSOFT digital IO card, these allow you to set the [unit ID](#) and [circuit ID](#) assigned to a channel. Without these being set, controllers will not react to lighting effects that you have put into your sequence.

For example, the following shows the Channel Settings dialog for a channel assigned to circuit 7 of a BSOFT digital IO card with unit ID 3:

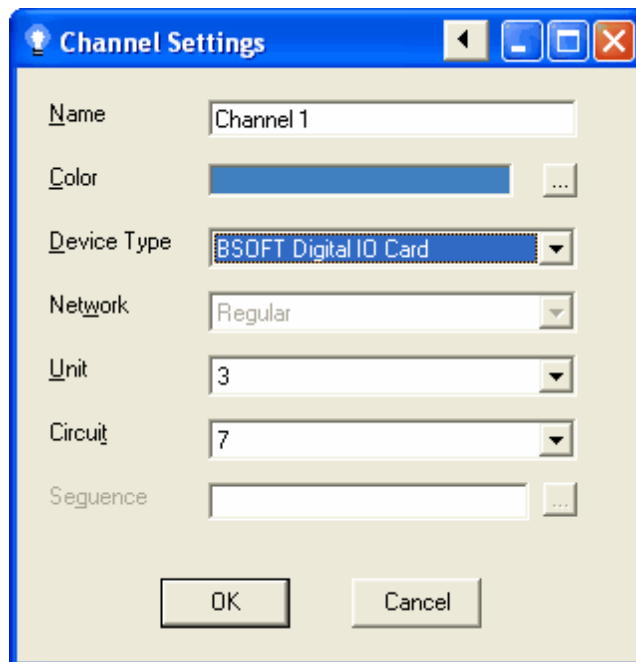

The Channel Settings dialog for a BSOFT digital IO card

The Channel Settings dialog can be accessed by left-clicking on the [channel's button](#), or by selecting "[Change Channel Settings](#)" from the [channel button's right-click popup menu](#). The Channel Configuration screen can be accessed by selecting "[Channel Configuration](#)" from the [Tools menu](#).

4.4.6 X10 Controllers

In addition to [Light-O-Rama controllers](#) and [various other types of controllers](#), Light-O-Rama can control your lights that are hooked up to CM11A X10 controllers.

Limitations of X10 Controllers

Not all of Light-O-Rama's [lighting effects](#) are supported on X10 controllers; to use effects other than "on" or "off" (such as [twinkling](#), [shimmering](#), [fading](#), and [brightness intensities](#) other than "totally off" or "full brightness"), you must use [Light-O-Rama controllers](#).

Additionally, X10 controllers do not react quickly to commands, so they are best used for portions of your display that are mostly static, changing infrequently. For more dynamic displays, it is best to use [Light-O-Rama controllers](#).

X10 is a very slow control mechanism. Commands take, on average, a full second to complete. When building a sequence that uses X10 controllers, you should not send commands to X10 devices more frequently than once a second. Note that turning on one light and turning off another is *two* commands, not one.

Light-O-Rama will allow up to fifty commands to be queued up to X10 controllers at any time. If that number is exceeded, then commands will be lost.

The X10 Port

All X10 controllers that you will use must be hooked up to your computer over a single COM port, known as the X10 Port. You can select which COM port is the X10 port in the "Additional Networks" section of the [Network Preferences dialog](#) of the [Edit menu](#) of the [Sequence Editor](#):

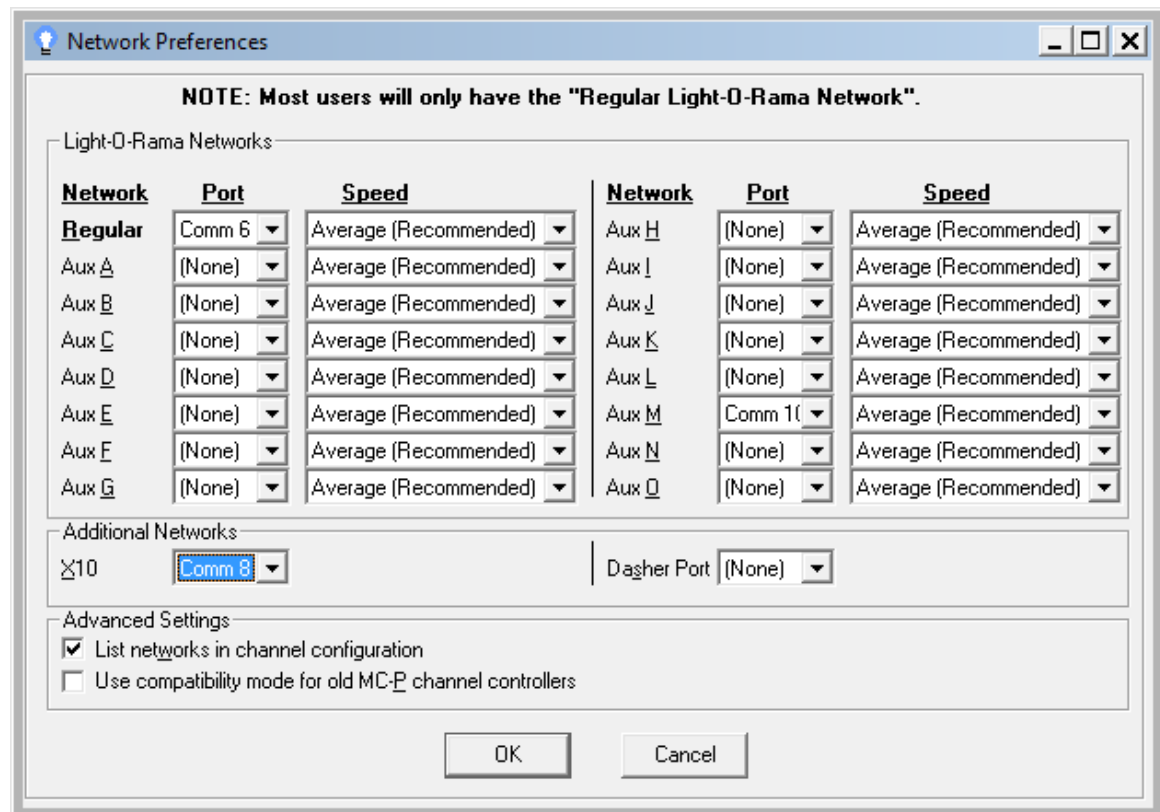

The Network Preferences dialog, with the X10 port set to COM8

Unit IDs

Each X10 controller has a unit ID, consisting of its X10 house code followed by its X10 unit code. X10 house codes are letters ranging from A to P, while X10 unit codes are numbers ranging from 1 to 16; hence, the X10 unit ID ranges from "A-1" to "P-16".

Assigning Circuits to Channels

When a [sequence](#) is created using the [Sequence Editor](#), each of its [channels](#) can be assigned a string of lights using the [Channel Settings dialog](#) or the [Channel Configuration screen](#) (the former may be more convenient for modifying a single channel, and the latter for modifying multiple channels at once).

For an X10 controller, these allow you to set the [unit ID](#) assigned to a channel. Without this being set, controllers will not react to lighting effects that you have put into your sequence.

For example, the following shows the Channel Settings dialog for a channel assigned to X10 controller C-7:

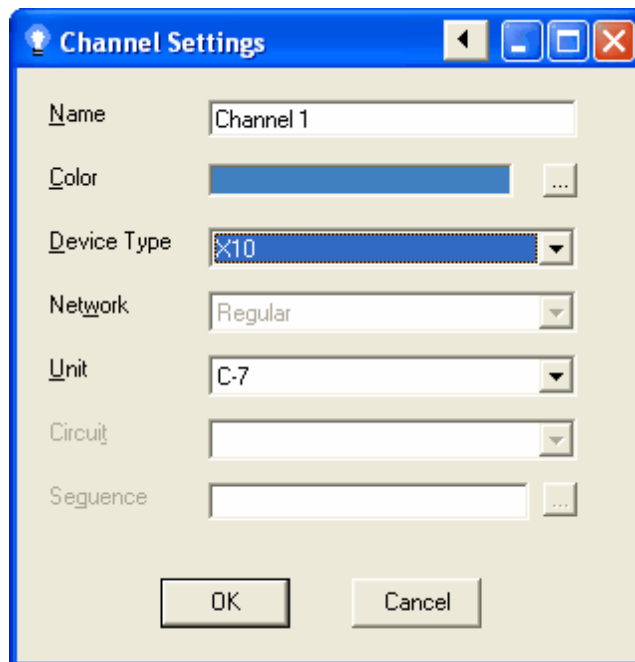

The Channel Settings dialog for an X10 controller

The Channel Settings dialog can be accessed by left-clicking on the [channel's button](#), or by selecting "[Change Channel Settings](#)" from the [channel button's right-click popup menu](#). The Channel Configuration screen can be accessed by selecting "[Channel Configuration](#)" from the [Tools menu](#).

5 The Light-O-Rama Software Package

The Light-O-Rama software package is a suite of programs, each helping with a different portion of computerized control of your lights to help build a dynamic display:

- The [Control Panel](#) runs in your system tray, and gives convenient access to control over your shows.
- The [Sequence Editor](#) is used to create, modify, and test sequences.
- The [SuperStar Sequencer](#) is a sort of front end to the Sequence Editor, used to create sequences visually rather than via a channels-versus-time grid.
- The [Show Editor](#) is used to package sequences together into shows.
- The [Schedule Editor](#) is used to schedule shows to play at certain times.
- The [Simple Show Builder](#) is an alternative to the Show Editor and the Schedule Editor. It is generally simpler to use, but less flexible.
- The [Show Player](#) monitors the schedule, and plays the scheduled shows at the appropriate times.
- The [Comm Listener](#) is used by other programs (such as the Sequence Editor and Show Player) to communicate with DMX devices.
- The [Hardware Utility](#) can be used to test your controllers, and to download sequences to them to be used in standalone mode.
- The [ServoDog Utility](#) can be used to configure Light-O-Rama ServoDog controllers.
- The [Visualizer](#) can be used to give a visual representation on your computer screen of how your lights will look when a sequence or your show plays.
- The [Verifier](#) can be used to check for certain types of problems with your Light-O-Rama configuration, schedule, shows and sequences.
- The [Diagnostic](#) is a troubleshooting tool that displays various information about your Light-O-Rama configuration.
- The [Offline Registration Utility](#) can be used to register Light-O-Rama on a computer that does not have access to the internet.

Additionally, several [add-ons](#) can be used with Light-O-Rama (these are not supplied as a part of the Light-O-Rama software package).

The Light-O-Rama software package must be [registered](#) with a valid license in order to use it to its full potential. There are several different possible license levels, each having [different features available](#). Light-O-Rama can also be used unlicensed, in Demo mode, but you will not be able to actually control lights while in Demo mode.

5.1 Registering Light-O-Rama

The [Light-O-Rama Software Package](#) must be registered, with a valid license, before it can be used to its full potential. Without a license, Light-O-Rama can be used as a demo, but it will not actually control your lights.

There are several different license levels, each having different features available; please see the [feature comparison](#) for details.

To register Light-O-Rama first visit the [Light-O-Rama website](#), and purchase a license. You will then be able to enter your license information in any of a few different ways: When you first install the software, or using the "[Register Light-O-Rama](#)" (or "Upgrade Light-O-Rama") menu items on the [Sequence Editor's Help menu](#) or on the [Control Panel's popup menu](#).

Doing any of these things will open the Registration dialog:

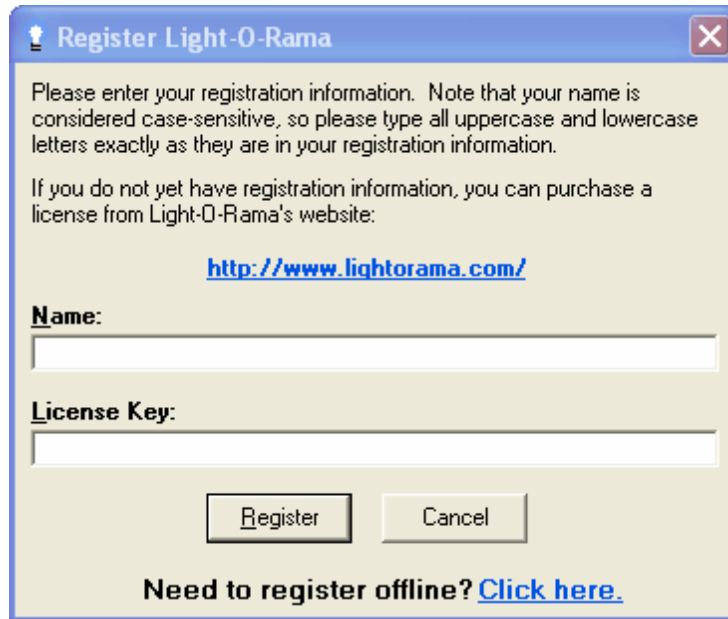

The Registration Dialog

If your computer is connected to the internet, you can register simply by entering the name and license key from your license information, and clicking "Register" (the license name and key can be copied and pasted from the email in which they were sent to you). Light-O-Rama will then automatically verify your license information, and, if it is valid, register your computer.

You may then have to close any Light-O-Rama programs that are running, and then restart them, before all of your newly available features will be available.

If your computer is not connected to the internet, click on the link at the bottom of the Registration dialog in order to [register offline](#).

5.1.1 Registering Offline

If your computer is connected to the internet, you can register Light-O-Rama directly in the [Registration dialog](#). If not, though, you can still register while offline. Open the Registration dialog and click the link at its bottom ("Need to register offline? Click here.").

Doing so will open the Offline Registration dialog:

Offline Registration

First, please enter your registration information. Note that your name is considered case-sensitive, so please type all uppercase and lowercase letters exactly as they are in your registration information:

Name:

License Key:

When you have entered them, please click the "Show Offline Registration Key" button:

Your Offline Registration Key:

Next, you will need an offline authorization key. If you have another computer, with LOR installed, which has internet access, you can get one by running the LOR Offline Registration Utility on that computer, and entering your license name, license key, and offline registration key into it.

If you do not have another computer, with LOR installed, with internet access, please call Light-O-Rama at 518-539-9000, and a person there will create an offline authorization key for you. You will need to provide the person with your license name, license key, and offline registration key.

After you have received your offline authorization key, please enter it below, and click the "Register" button:

If a box turns red, that means that LOR has detected an error in that box, so please double-check what you have typed in it.

The Offline Registration Dialog

Once this dialog is opened, follow the instructions on it to register offline. A brief summary:

First, enter your license name and license key (these can be copied and pasted from the email in which they are sent to you).

Next, click "Show Offline Registration Key".

At this point, you will need to use your offline registration key to get an offline authorization key. There are two ways to do this:

First, if you have another computer, which is connected to the internet and which has Light-O-Rama installed, you can run the [Offline Registration Utility](#) on that computer. Make sure to have your license name, license key, and offline registration key available to enter onto that computer; the Offline Registration Utility will use them to create an offline authorization key.

If you do not have another computer that you can use to run the Offline Registration Utility, then you can obtain an offline authorization key by calling Light-O-Rama, at the telephone number shown on the form. Provide the person you speak to with your license name, license key, and offline registration key, and they will provide an offline authorization key to you.

After you have obtained an offline authorization key, type it into the boxes near the bottom of the form, and click "Register".

After you have successfully registered, you may need to close any Light-O-Rama programs that are running and restart them before all of your newly available features can be used.

5.2 Control Panel

What is the Light-O-Rama Control Panel?

The Light-O-Rama Control Panel is an application that runs in your system tray, allowing convenient access to other programs in the [Light-O-Rama software package](#), as well as control over your displays.

The Light-O-Rama control panel *must* be running in order for the [Show Player](#) to play your [scheduled shows](#) (additionally, "[Enable Schedule](#)" must be turned on).

Running the Light-O-Rama Control Panel

To run the Light-O-Rama Control Panel, select it from your computer's Start menu, under All Programs / Light-O-Rama / Light-O-Rama Control Panel:

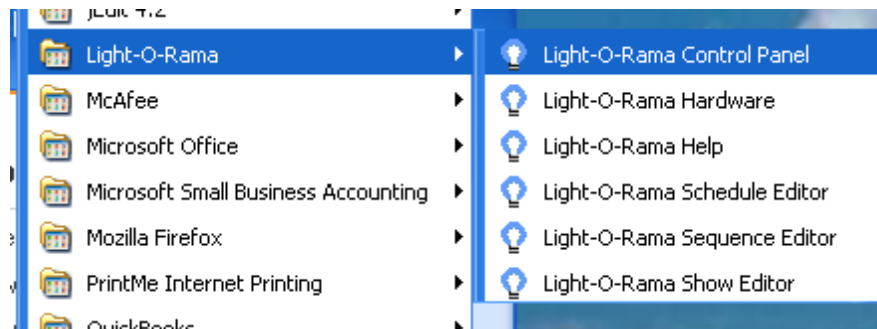

Run the Light-O-Rama Control Panel from your computer's Start menu

Once running, the Control Panel will show up as a Light-O-Rama light bulb icon in your system tray:



The Control Panel, running in the system tray

The color of the light bulb describes the current state of the [Show Player](#): If [scheduled shows](#) are currently [enabled](#), it will be blue; if they are [disabled](#), but [shows on demand](#) are enabled, it will be orange; if shows are disabled entirely, it will be red.

If you wish, you can set it up so that the Control Panel will automatically be run whenever your computer starts up (and therefore you won't have to start it via the Start menu anymore). To do this, select [Launch at Startup](#) from the [Control Panel's popup menu](#).

The Status Window

Left-clicking on the Light-O-Rama Control Panel's icon in your computer's system tray opens up the Light-O-Rama status window. This window shows whether or not the [Light-O-Rama Show Player](#) is

currently monitoring your [schedule](#) to play [shows](#) at their scheduled times, and, if so, whether a show is currently running, what show that is, and what the next show will be.

It also shows various log messages, indicating such things as that a show or a [sequence](#) is starting or stopping, that an error occurred playing a sequence, or that an [interactive trigger](#) was detected. The "Clear Log" button will clear out all existing messages from the display, and "Copy Log" will copy the log messages to your computer's clipboard, so that you can paste them into a file. Please note that the log does not retain its messages indefinitely; it will periodically clear earlier messages out.

If that status window says that Light-O-Rama is "disabled", your scheduled shows will not play. If you wish to enable them, select "[Enable Schedule](#)" from the [Control Panel's right-click popup menu](#). Similarly, if the status window says that they Light-O-Rama is "enabled", your scheduled shows will play; if you wish to disable them, select either "[Disable Shows Gracefully](#)" or "[Disable Shows Immediately](#)".

The status window can also say that Light-O-Rama is "enabled (only for on demand shows)", in which case your scheduled shows will not play, but [on demand shows](#) will. In this situation, you will be able to either enable your scheduled shows or disable shows entirely (either gracefully or immediately).

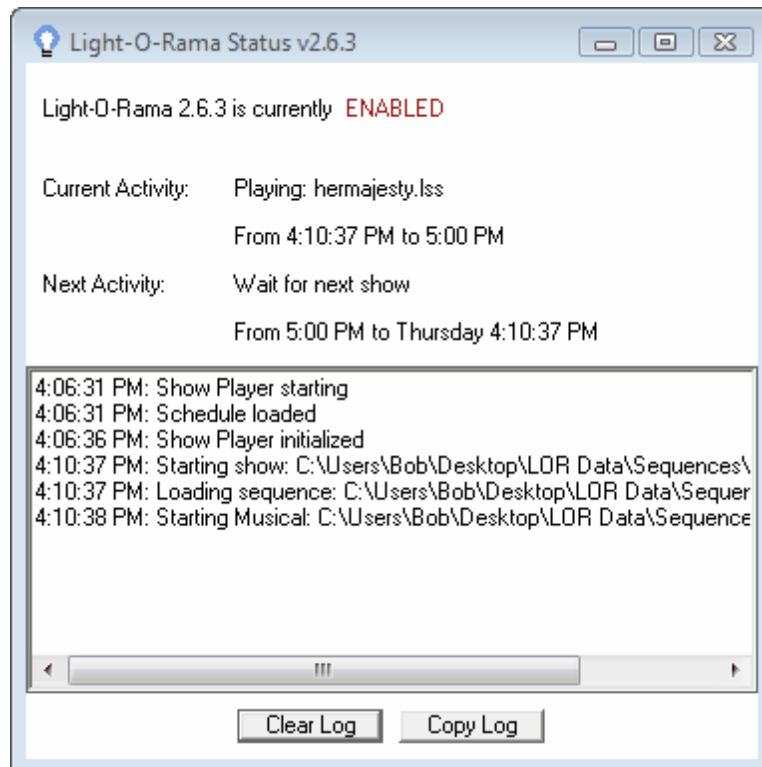

The status window, with scheduled shows enabled and a show currently playing

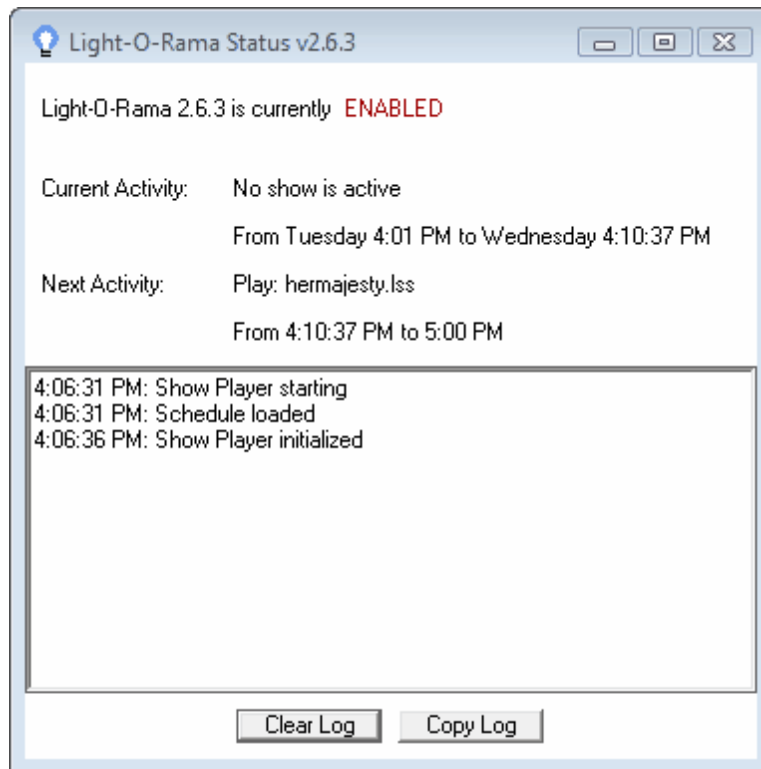

The status window, with scheduled shows enabled, but no show currently playing

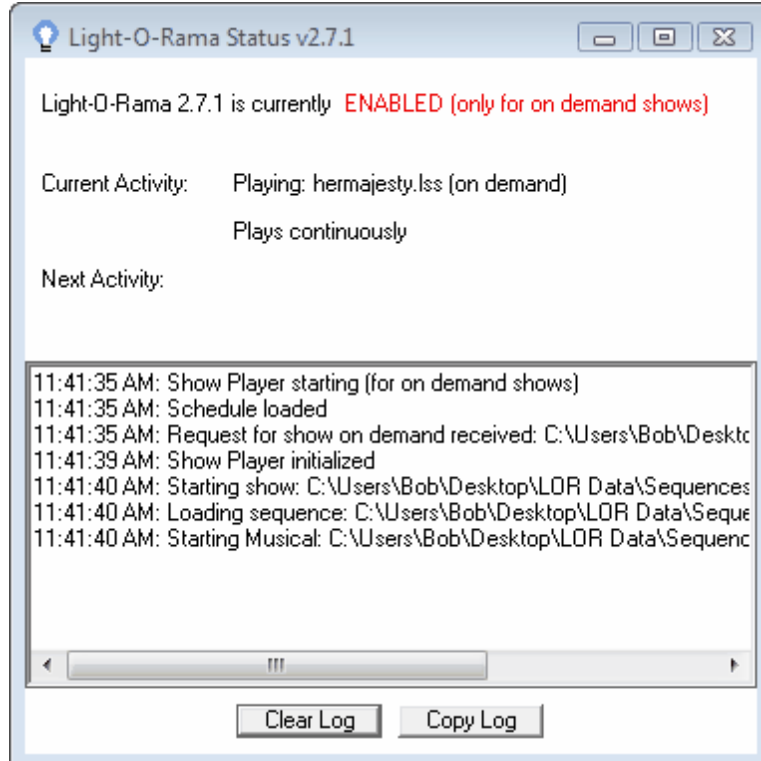

The status window, with on demand shows enabled, but not scheduled shows

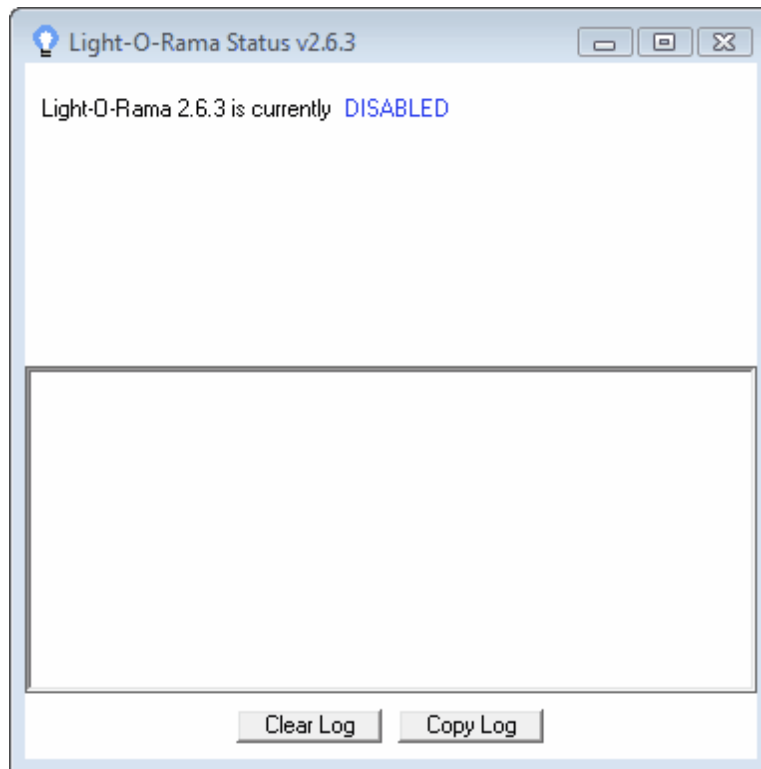

The status window, with shows disabled

The Popup Menu

Right-clicking on the Light-O-Rama Control Panel's icon in the system tray brings up a popup menu.

This menu contains items to quickly launch other programs in the Light-O-Rama software package, and to control your display in various ways:

- [Register \(or Upgrade\) Light-O-Rama](#)
- [Sequence Editor](#)
- [Show Editor](#)
- [Simple Show Builder](#)
- [Schedule Editor](#)
- [Visualizer](#)
- [Verifier](#)
- [Status](#)
- [Hardware Utility](#)
- [ServoDog Utility](#)
- [Enable Schedule](#)
- [Disable Shows Gracefully](#)
- [Disable Shows Immediately](#)
- [Show On Demand](#)
- [Shut Down Show On Demand](#)
- [Launch at startup](#)
- [Use Holiday Lights Designer](#)
- [Use the LOR Visualizer](#)
- [Use Compressed Sequences](#)
- [Unload Light-O-Rama](#)
- [Close Menu](#)

- [Help](#)

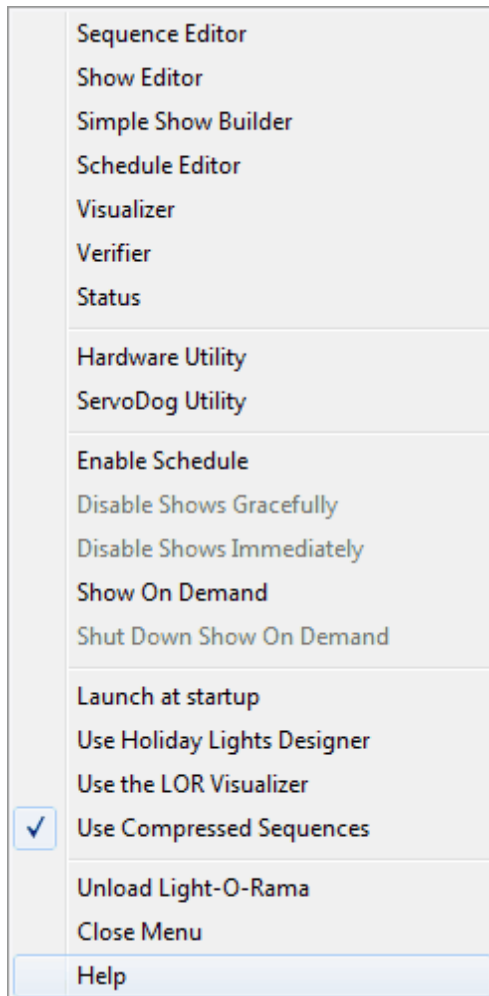

The Control Panel's right-click popup menu

Register (or Upgrade) Light-O-Rama

Selecting "Register Light-O-Rama" (or "Upgrade Light-O-Rama") from the Control Panel's right-click popup menu allows you to [register your Light-O-Rama software](#), or to upgrade to a higher level license, unlocking various [features](#).

This item will show up as "Register Light-O-Rama" if you are using the unlicensed Demo version of the software, or "Upgrade" if you are using a license, but it is not the highest possible license level. If you are using the highest possible license level, this item will not be displayed at all.

Sequence Editor

Selecting "Sequence Editor" from the [Control Panel's right-click popup menu](#) launches the [Light-O-Rama Sequence Editor](#), used to create, modify, and test [sequences](#).

Show Editor

Selecting "Show Editor" from the [Control Panel's right-click popup menu](#) launches the [Light-O-Rama Show Editor](#), used to create and modify [shows](#).

Simple Show Builder

Selecting "Simple Show Builder" from the [Control Panel's right-click popup menu](#) launches the [Light-O-Rama Simple Show Builder](#), which is intended as an easier to use, but less flexible, alternative to the [Show Editor](#) and the [Schedule Editor](#).

Schedule Editor

Selecting "Schedule Editor" from the [Control Panel's right-click popup menu](#) launches the [Light-O-Rama Schedule Editor](#), used to [schedule shows](#) to be played by the [Light-O-Rama Show Player](#).

Visualizer

Selecting "Visualizer" from the [Control Panel's right-click popup menu](#) launches the Light-O-Rama Visualizer.

Verifier

Selecting "Verifier" from the [Control Panel's right-click popup menu](#) launches the [Light-O-Rama Verifier](#), used to check for certain problems with Light-O-Rama's configuration, [schedule](#), scheduled [shows](#), and scheduled [sequences](#).

Status

Selecting "Status" from the [Control Panel's right-click popup menu](#) opens the [Light-O-Rama status window](#), which displays information such as whether [shows](#) are currently enabled, and what show (if any) is currently playing.

Hardware Utility

Selecting "Hardware Utility" from the [Control Panel's right-click popup menu](#) launches the [Light-O-Rama Hardware Utility](#), used for various things such as testing [controllers](#) and downloading [sequences](#) to them for use in standalone mode.

ServoDog Utility

Selecting "ServoDog Utility" from the [Control Panel's right-click popup menu](#) launches the [Light-O-Rama ServoDog Utility](#), used to configure Light-O-Rama ServoDog controllers.

Enable Schedule

Selecting "Enable Schedule" from the [Control Panel's right-click popup menu](#) causes the [Light-O-Rama Show Player](#) to monitor your [schedule](#) and to play your [shows](#) at their scheduled times.

Note that [on demand shows](#) can be played regardless of whether your scheduled shows are enabled or not.

When scheduled shows are enabled, the light bulb icon in the computer's system tray will be blue.

Note: If "Enable Schedule" is greyed out, this means that it has already been selected, and the Show Player is monitoring your schedule. To stop the Show Player from monitoring your schedule, select "[Disable Shows Gracefully](#)" or "[Disable Shows Immediately](#)".

Disable Shows Gracefully

Selecting "Disable Shows Gracefully" from the [Control Panel's right-click popup menu](#) causes the [Light-O-Rama Show Player](#) to put your current [show](#) (if one is running) into shutdown mode, and to stop monitoring your [schedule](#) for shows to be played. When the show goes into shutdown mode, any song from the [Musical section](#) that is currently playing will be allowed to finish, and then the show's [Shutdown section](#) will start.

To instead shut down your show immediately, including abruptly stopping any [sequences](#) or song that might be playing, choose [Disable Shows Immediately](#) instead.

When shows are disabled, the light bulb icon in the computer's system tray will be red.

Note: If "Disable Shows Gracefully" is greyed out, this means that the Show Player is *not* monitoring your schedule. To have the Show Player start monitoring your schedule, select "[Enable Schedule](#)".

Disable Shows Immediately

Selecting "Disable Shows Immediately" from the [Control Panel's right-click popup menu](#) causes the [Light-O-Rama Show Player](#) to immediately stop your current show (if one is running), and to stop monitoring your [schedule](#) for [shows](#) to be played.

Stopping your show immediately will abruptly stop your [sequences](#), including any song that happens to be playing. To have the Show Player stop your show more gracefully, choose [Disable Shows Gracefully](#) instead.

When shows are disabled, the light bulb icon in the computer's system tray will be red.

Note: If "Disable Shows Immediately" is greyed out, this means that the Show Player is *not* monitoring your schedule. To have the Show Player start monitoring your schedule, select "[Enable Schedule](#)".

Show On Demand

Selecting "Show On Demand" from the [Control Panel's right-click popup menu](#) causes the following dialog to open:

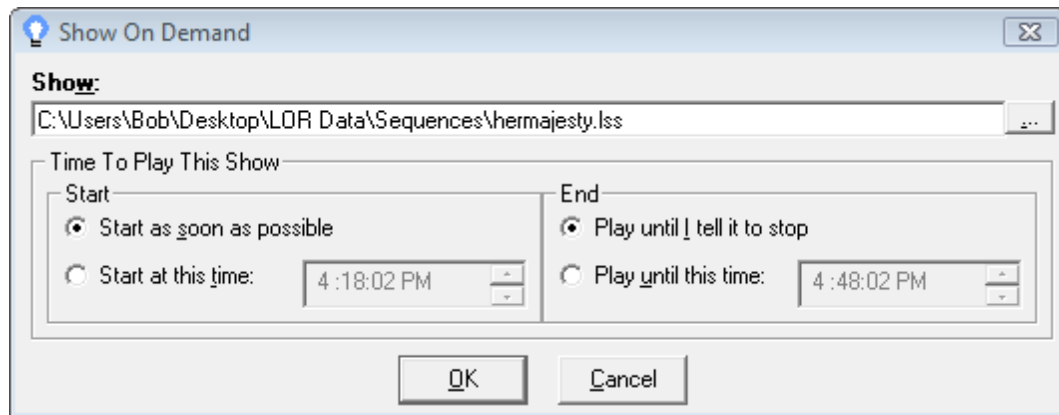

The Show On Demand dialog

Using this dialog, you can choose a [show](#) file to play immediately, or at a certain time, without needing to add it to your [schedule](#). You can choose to let it play until a certain time, or else indefinitely, in which case it will not stop until you "[shut down show on demand](#)", "[disable shows gracefully](#)", "[disable shows immediately](#)", or "[unload Light-O-Rama](#)".

If a show is already playing at the time the on demand show is supposed to start, the playing show will be allowed to stop gracefully before the on demand show will start. That is, if a [sequence](#) from its [Musical Section](#) is currently playing, that sequence will be allowed to continue to play until its natural end; also, the sequences from its [Shutdown Section](#), if any exist, will be played (after the current sequence from the Musical Section ends, or immediately if there is no current sequence from the Musical Section).

If "Show On Demand" is used when scheduled shows are disabled, it will not enable your scheduled shows; only your on demand show will play (if desired, though, you can enable your scheduled shows too, simply by clicking "[Enable Schedule](#)"). When this is the case, the light bulb icon in the computer's system tray will be orange.

Please note that the Show On Demand feature is only available for [license level](#) Basic Plus and higher.

Shut Down Show On Demand

If an [on demand show](#) is currently playing, selecting "Shut Down Show On Demand" from the [Control Panel's right-click popup menu](#) will cause the on demand show to stop. It will be allowed to stop gracefully; that is, if a [sequence](#) from its [Musical Section](#) is currently playing, that sequence will be allowed to continue to play until its natural end; also, the sequences from its [Shutdown Section](#), if any exist, will be played (after the current sequence from the Musical Section ends, or immediately if there is no current sequence from the Musical Section).

After the on demand show stops, if [scheduled shows are enabled](#), the [Show Player](#) will start whatever show is [scheduled](#) for the current time (if any).

"Shut Down Show On Demand" can also be used to cancel an on demand show that has been requested, but not yet started (either due to its start time not having been reached, or else due to another show still being in the process of shutting down).

Launch at startup

Checking "Launch at startup" from the [Control Panel's right-click popup menu](#) causes the [Light-O-Rama Control Panel](#) to automatically run whenever your computer starts up. Unchecking it causes it not to run at startup time, in which case you can start it manually whenever you like.

Use Holiday Lights Designer

Checking "Use Holiday Lights Designer" from the [Control Panel's right-click popup menu](#) causes Light-O-Rama to send lighting commands to [Holiday Lights Designer](#) whenever a sequence is played (whether by the Show Player or the Sequence Editor). Holiday Lights Designer is a third party add-on that allows you to virtually place Christmas lights and holiday decorations on images of your home or business. Unchecking it causes Light-O-Rama not to send such commands to Holiday Lights Designer.

Version 4.0 or above of Holiday Lights Designer™ is required to take advantage of Light-O-Rama interaction.

Use the LOR Visualizer

Checking "Use the LOR Visualizer" from the [Control Panel's right-click popup menu](#) causes Light-O-Rama to send lighting commands to the [Light-O-Rama Visualizer](#). Unchecking it causes Light-O-Rama not to send such commands.

Use Compressed Sequences

Checking "Use Compressed Sequences" from the [Control Panel's right-click popup menu](#) causes the Light-O-Rama [Show Player](#) to create and use [compressed sequences](#) if possible, which should cut down on the time it takes to load. Unchecking it causes it to ignore compressed sequences, and instead use the regular [sequences](#).

Unload Light-O-Rama

Selecting "Unload Light-O-Rama" from the [Control Panel's right-click popup menu](#) will shut down both the [Light-O-Rama Control Panel](#) and the [Light-O-Rama Show Player](#). Your [scheduled shows](#) will *not* run while these are shut down.

To start the Light-O-Rama Control Panel again, [run it from your computer's Start menu](#). Or, if "[Launch at startup](#)" has been enabled, the Control Panel will automatically run the next time that your computer starts up.

Close Menu

Selecting "Close Menu" from the [Control Panel's right-click popup menu](#) will close the popup menu. The Light-O-Rama control panel will still remain active.

Help

Selecting "Help" from the [Control Panel's right-click popup menu](#) will open up the Light-O-Rama help files.

5.3 Sequence Editor

The Light-O-Rama Sequence Editor is a tool used to create [sequences](#), which are files that contain commands to be sent to [controllers](#) to produce various [lighting effects](#) - to turn lights [on and off](#), make them [twinkle](#) or [shimmer](#), [fade up or down](#), and so forth.

After creating sequences with the Sequence Editor, they can be grouped together into [shows](#), using the [Show Editor](#). Shows can then be [scheduled](#) to run at certain times, using the [Schedule Editor](#), and the [Show Player](#) can be used to monitor the schedule and play those shows at the scheduled times.

A sequence is represented in the Sequence Editor as a grid, with rows being [channels](#) and columns being [timings](#). A cell in the grid represents the [lighting effect](#) or effects on that channel at that time. For example, the following sequence has four channels. At the start of the sequence, the first channel turns [on](#). It stays on for half a second, then turns off, and the second channel then turns on. Then it turns off, and the third turns on, and then the third turns off and the fourth turns on. This brings us two seconds into the sequence, at which point all four channels [fade down](#), for a second. After that, the first and fourth channels start [shimmering](#), while the second and third fade up:

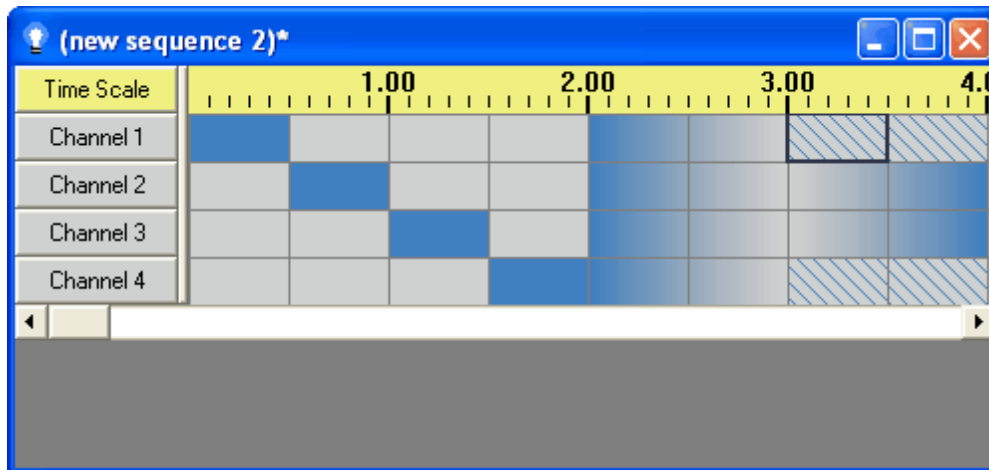

A sequence with four channels, and various lighting effects

Notice that one cell is highlighted with a thick black box - the cell of the first channel from 3 seconds to 3.5 seconds. That is the currently selected cell. Various tools can be applied to the selected cell (or cells), for example to change the lighting effect used on that channel at that time.

For more detailed information about sequences and the Sequence Editor, please see the help file page on [sequences](#), and the following topics:

- [Editing Sequences Using the Keyboard](#)
- [Editing Sequences Using the Mouse](#)
- [The Menu Bar](#)
- [Toolbars](#)
- [The Right-Click Context Menu](#)
- [Channel Buttons](#)
- [Track Bars](#)
- [Loop Menus](#)
- [The Channel Configuration Screen](#)
- [The Animator](#)
- [The Beat Wizard](#)

- [The MIDI Wizard](#)
- [The Tapper Wizard](#)
- [The VU Wizard](#)

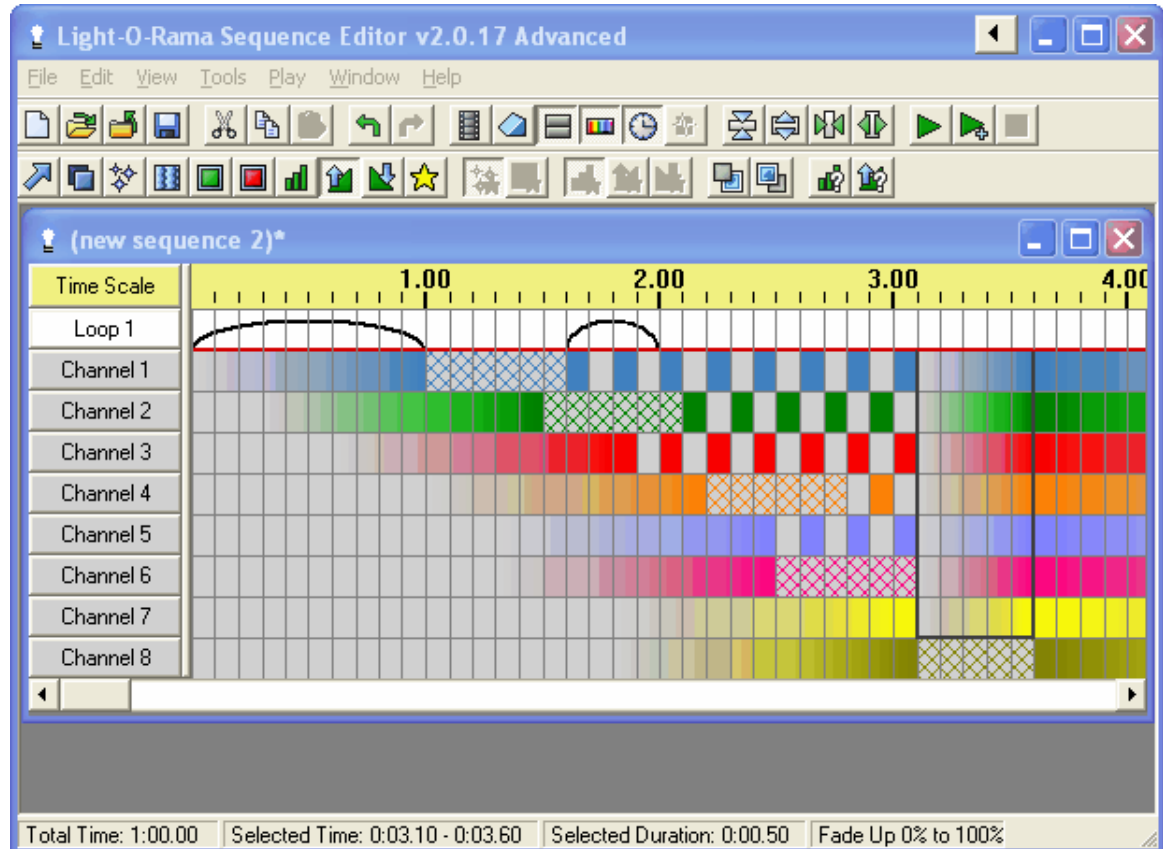

The Light-O-Rama Sequence Editor, with a sequence

5.3.1 Editing Sequences Using the Keyboard

The keyboard can be used in several ways to help build [sequences](#) in the [Sequence Editor](#):

- [Custom Keyboard Mappings](#)
- [Selecting a Cell](#)
- [Selecting Multiple Cells](#)
- [Modifying Cells](#)
- [Copying, Cutting and Pasting](#)
- [Copying and Pasting Timings](#)
- [Undoing and Redoing](#)
- [Zooming](#)
- [Creating and Opening Sequences](#)
- [Saving Changes](#)
- [Refreshing the Display](#)
- [Help](#)
- [Freeform Play Mode](#)
- [Opening a Tooltip](#)
- [Other Keyboard Usage](#)

Please also see [Editing Sequences Using the Mouse](#).

Custom Keyboard Mappings

Although Light-O-Rama has certain built-in keyboard behaviors -- for example, pushing the S key will cause a shimmer to be applied to the current selection -- you can change these behaviors. For example, you could change the S key so that it will cause a fade up to be applied, instead of a shimmer. Or, you could make it more complex, such as causing a shimmer to be applied, then the selection to be moved two cells to the right, and then a fade up applied (to the new selection).

For further details on custom keyboard mappings, please see the [Keyboard Preferences](#) page. The remainder of this help file page describes Light-O-Rama's built-in keyboard behaviors.

Selecting a Cell

[Sequences](#) are displayed in the [Sequence Editor](#) as a grid. Rows represent [channels](#) or [RGB channels](#), and columns represent [timings](#). Cells in the grid therefore represent the [lighting effects](#) that will happen on channels at various points in time while the sequence is being played.

A cell, or a range of cells, can be selected, allowing you to apply various tools to it (such as specifying what lighting effects should take place in that cell). You can recognize the currently selected cell (or cells) by a thick black and white border. For example, in the following sequence, the cell of the third channel between 1 second and 1.5 seconds is selected:

Time Scale	1.00			
Unit 01.1				
Unit 01.2				
Unit 01.3				
Unit 01.4				
Unit 01.5				
Unit 01.6				

The time between 1 and 1.5 seconds of the third channel is selected

You can change which cell is selected by using the arrow keys - Up, Down, Left and Right. Page Up and Page Down can also be used, to go up and down in the sequence by a page at a time.

If the currently selected cell is not the first cell in the currently selected channel (i.e. the cell starting at time zero), hitting the Home key brings you to the first cell in the currently selected channel. If, however, the first cell is already selected, then hitting the Home key will bring you to the first channel in the sequence. So, hitting the Home key twice in a row will bring you to the first cell in the first channel.

The End key works similarly, but for the last event and the last channel.

Selecting Multiple Cells

A range of cells can be selected by holding down the shift key while using the arrow keys (or Page Up, Page Down, Home, or End). For example, the following picture has four cells selected, two each from second and third channels:

Time Scale	1.00											
Unit 01.1												
Unit 01.2												
Unit 01.3												
Unit 01.4												
Unit 01.5												
Unit 01.6												

Four cells are currently selected, two each in Channel 2 and Channel 3

Modifying Cells

Once you have selected a cell, or a range of cells, you can modify the cell or cells by pressing keys:

Key	Effect
<Shift>-A	Set the currently selected tool (for the Enter key or mouse click) to the Intelligent Fade tool
A	Intelligent Fade
<Shift>-C	Set the currently selected effect tool (for the Enter key or mouse click) to the Custom tool
C	Custom tool (e.g. twinkling fade down)
<Ctrl><Shift>-D	Set the custom tool to fade down
<Shift>-D	Set the currently selected effect tool (for the Enter key or mouse click) to the Fade Down tool
D	Fade down
<Shift>-E	Turn on regular effects mode for subsequent keystrokes
E	Turn on regular effects mode for the next keystroke only
<Shift>-F	Set the currently selected effect tool (for the Enter key or mouse click) to the Fill tool
F	Fill
<Shift>-G	Set the currently selected effect tool (for the Enter key or mouse click) to the Toggle tool
G	Toggle
<Shift>-H	Set the currently selected effect tool (for the Enter key or mouse click) to the Chase tool
H	Chase
<Ctrl><Shift>-I	Set the custom tool to set intensity
<Shift>-I	Set the currently selected effect tool (for the Enter key or mouse click) to the Intensity tool
I	Set intensity
<Shift>-K	Turn on or off background effects mode for subsequence keystrokes
K	Turn on background effects mode for the next keystroke only
<Shift>-L	Set the currently selected effect tool (for the Enter key or mouse click) to the Select tool

<Shift>-N	Set the currently selected effect tool (for the Enter key or mouse click) to the On tool
N	On
<Shift>-O	Set the currently selected effect tool (for the Enter key or mouse click) to the Color Fade tool
O	Color fade
<Shift>-Q	Set the currently selected effect tool (for the Enter key or mouse click) to the Paint Sequence tool
Q	Paint sequence
<Shift>-R	Turn on or off foreground effects mode for subsequent keystrokes
R	Turn on foreground effects mode for the next keystroke only
<Ctrl><Shift>-S	Set the custom tool to shimmer
<Shift>-S	Set the currently selected effect tool (for the Enter key or mouse click) to the Shimmer tool
S	Shimmer
<Ctrl><Shift>-T	Set the custom tool to twinkle
<Shift>-T	Set the currently selected effect tool (for the Enter key or mouse click) to the Twinkle tool
T	Twinkle
<Ctrl><Shift>-U	Set the custom tool to fade up
<Shift>-U	Set the currently selected effect tool (for the Enter key or mouse click) to the Fade Up tool
U	Fade Up
<Shift>-X	Set the currently selected effect tool (for the Enter key or mouse click) to the DMX Intensity tool (Note: this key only works if DMX Editing has been enabled)
X	DMX Intensity (Note: this key only works if DMX Editing has been enabled)
+	Repeat
<Shift>-<Delete>	Set the currently selected effect tool (for the Enter key or mouse click) to the Off tool
<Delete>	Off
<Enter>	Use the currently selected effect tool (from the Tools toolbar)

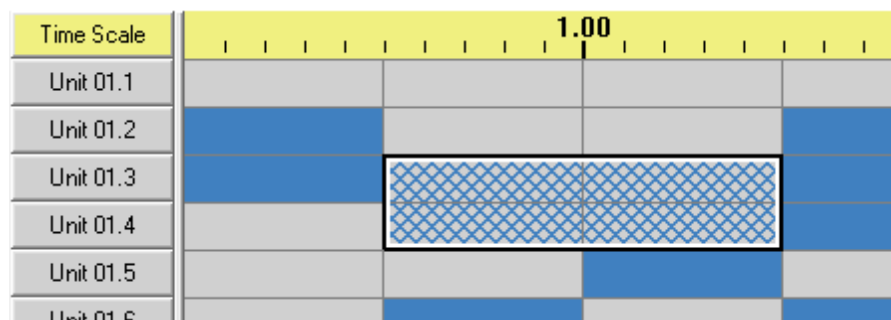

The selected cells have been changed to twinkles

Copying, Cutting and Pasting

The [lighting effects](#) in cells can be copied, cut, and pasted using the standard Windows copy, cut and paste keys, Ctrl-C, Ctrl-X, and Ctrl-V.

Note that the Light-O-Rama Sequence Editor supports two different pasting modes ([paste by cell](#) and [paste by time](#)), and a pasting option ([paste from foreground](#)). You can choose these settings using the [Clipboards](#) subpanel of the left-hand [Tools Panel](#).

Copying and Pasting Timings

[Timings](#) can be copied using Ctrl-Insert, and inserted using Shift-Insert.

Undoing and Redoing

Changes to a [sequence](#) can be undone and redone using the standard Windows undo and redo keys, Ctrl-Z and Ctrl-Y. Note that this includes any changes to the sequence, not merely changes made using the keyboard.

Zooming

The view of a [sequence's](#) grid can be zoomed in and out using the keyboard. Both rows ([channels](#)) and columns ([timings](#)) can be zoomed.

To zoom in on channels - i.e. to make them bigger - use Alt-Down, and to zoom out, use Alt-Up. Alt-Page Down and Alt-Page Up also work, to zoom in and out as much as possible.

To zoom in on timings, use Alt-Right; to zoom out, use Alt-Left. Alt-End and Alt-Home zoom in and out as much as possible.

Creating and Opening Sequences

The [New and Open Dialog](#) can be opened using either Ctrl-N, Ctrl-O, or Ctrl-R. Ctrl-N will open it to its [New Sequence tab](#), Ctrl-O will open it to its [Existing Sequence tab](#), and Ctrl-R will open it to its [Recent Sequence tab](#).

Saving Changes

Changes to a [sequence](#) can be saved using Ctrl-S. If this is a new sequence that has never before been saved, this will first prompt you for a filename to save the sequence to.

Refreshing the Display

Occasionally during play, the display of a [sequence's](#) grid may seem to blank out. This is typically caused when your computer happens to do something unrelated to Light-O-Rama, and temporarily takes the focus away from the [Sequence Editor](#). The sequence itself is not affected, nor are the actual lights - only the Sequence Editor's display of the sequence is - and the display is typically returned to normal when play reaches the next screen (or stops). However, if you do not wish to wait for that, you can hit the F5 key to manually refresh the display.

Help

The Light-O-Rama help file can be opened by hitting the F1 key.

Freeform Play Mode

The space bar can be used to start and stop the current sequence either in "[from selection](#)" mode or, if a freeform play range has been selected, in [freeform play mode](#). While playing, the up and down arrows can be used to define a freeform play range. If play is started with "Shift-Space" instead of just "Space", the freeform play range will be removed, and play will then start in "from selection" mode.

Opening a Tooltip

If your mouse is over the current [sequence's](#) grid, you can open a tooltip describing the cell it is pointing to by hitting the "P" key. This can be done regardless of whether you have set your [display preferences](#) to disable tooltips.

Other Keyboard Usage

The various menus on the menu bar can be accessed by holding down the Alt key while pressing a particular key for the menu in question:

Key	Effect
<Alt>-E	The Edit menu
<Alt>-F	The File menu
<Alt>-H	The Help menu
<Alt>-P	The Play menu
<Alt>-T	The Tools menu
<Alt>-V	The View menu
<Alt>-W	The Window menu

After opening a menu, menu items can be selected using their hotkeys (indicated by an underlined letter). For example, pressing Alt-E followed by K will select "[Duplicate Track](#)" from the Edit menu. Keys such as Up, Down, Left, Right, Enter and Space can also be used to navigate these menus.

Many functions in the Light-O-Rama Sequence Editor cause dialog windows to open up. Those which have "OK" and "Cancel" buttons can typically have "OK" invoked by hitting the Enter key, and "Cancel" by hitting the Escape key.

Standard Windows keyboard navigation should work on these dialogs - for example, using the Tab key to tab between controls, or the arrow keys to choose which radio button in a group is selected.

Hotkeys exist on many of these dialogs, which allow you to select a specific control on the dialog by holding the Alt key and pressing the key of the underlined letter. For example, in the [Channel Settings dialog](#) (picture follows), the "Name" control can be selected by Alt-N, the "Color" control by Alt-C, and so forth:

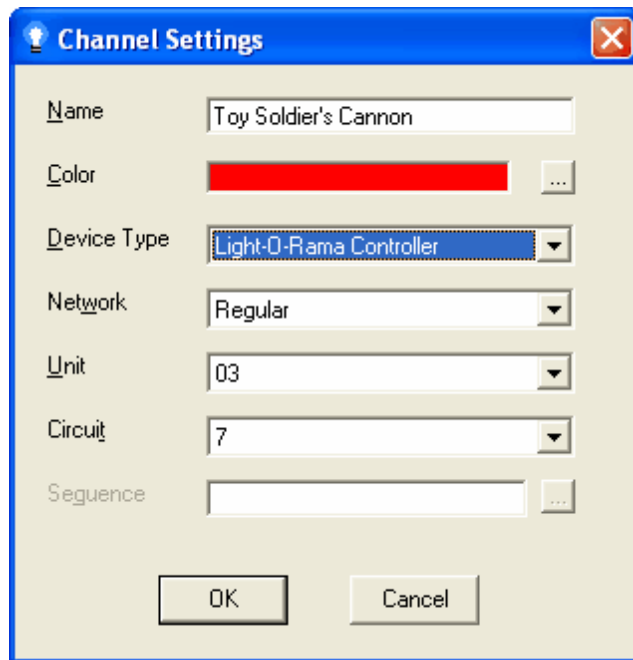

The Channel Settings dialog

5.3.2 Editing Sequences Using the Mouse

[Sequences](#) can be edited in the [Light-O-Rama Sequence Editor](#) using the mouse:

- [Selecting a Cell](#)
- [Selecting Multiple Cells](#)
- [Modifying Cells](#)
- [Other Mouse Usage](#)

See also "[Editing Sequences Using the Keyboard](#)".

Selecting a Cell

[Sequences](#) are displayed in the [Sequence Editor](#) as a grid. Rows represent [channels](#), and columns represent [timings](#). Cells in the grid therefore represent the [lighting effects](#) that will happen on channels at various points in time while the sequence is being played.

A cell, or a range of cells, can be selected, allowing you to apply various tools to it (such as specifying what lighting effects should take place in that cell). You can recognize the currently selected cell (or cells) by a thick black and white border. For example, in the following sequence, the cell of the third channel between 1 second and 1.5 seconds is selected:

Time Scale	1.00			
Unit 01.1				
Unit 01.2				
Unit 01.3				
Unit 01.4				
Unit 01.5				
Unit 01.6				

The time between 1 and 1.5 seconds of the third channel is selected

Using the mouse, you can change which cell is selected by simply clicking in the cell that you want to be selected. However, unlike when you select a cell [using the keyboard](#), this will not just select the cell - it will also apply the current effect tool (from the [Tools toolbar](#)) to the cell. So, for example, it might turn the cell [on](#), or [off](#), or cause it to [twinkle](#), or [fade up](#). So, if you want to just select a cell without changing its contents, either use the keyboard, or make sure that your current effect tool is the [Selection tool](#).

Another option is to right-click in the desired cell. This will select the cell, and will not apply the current tool, but it will also bring up the [right-click context menu](#). One exception: If you already have multiple cells selected, and you right click on one of those cells, that cell will not become the currently selected cell. Instead, the whole range of cells will remain selected, and the right-click context menu will pop up, applying to the entire range of cells.

Selecting Multiple Cells

You can select multiple cells using the mouse in two ways: either click and drag from the first to the last, or click in the first, move (without necessarily dragging) to the last, and shift-click in the last. Note that this will not just select the cells; it will also apply the current tool (from the [Tools toolbar](#)) to the cells. For example, it will make them [shimmer](#), or [fade down](#). So, if you want to select multiple cells without changing their contents, either use the keyboard, or make sure that the current tool is the [Selection tool](#).

Right-clicking can also be used to select multiple cells, but will bring up the [right-click context menu](#) rather than applying the current tool.

Time Scale	1.00									
Unit 01.1										
Unit 01.2										
Unit 01.3										
Unit 01.4										
Unit 01.5										
Unit 01.6										

Four cells are selected, two each in two different channels

Modifying Cells

Simply [selecting a cell](#) or [a range of cells](#) will apply the current [effect](#) tool (from the [Tools toolbar](#)) to the selection.

Another option is to right-click on the cell or cells, which will bring up the [right-click context menu](#). This menu has a variety of options for modifying the cells.

Other Mouse Usage

Various popup menus and dialogs can be obtained by using the mouse:

- Right-clicking on the sequence grid brings up the [right-click context menu](#).

- Left-clicking on a [channel button](#) brings up that channel's [Channel Settings dialog](#).
- Right-clicking on a channel button brings up that [channel's popup menu](#).
- Left or right-clicking on a [track bar](#) brings up that [track's context menu](#).
- Left or right-clicking on a loop level portion of the grid brings up the [Loop Context menu](#).
- Left or right-clicking on a [loop level's button](#) brings up part of the Loop Context menu (the items related to the whole loop level, rather than individual loops).

Additionally, the [menu bar](#) and the [toolbars](#) can be accessed via the mouse in the standard way for Windows programs.

5.3.3 Time Format

Whenever the [Light-O-Rama Sequence Editor](#) asks you for a length of time, you can generally specify hours, minutes, seconds, and hundredths of a second. You don't have to specify all of them if you don't want to.

The general format is:

HH:MM:SS.hh

Where HH is hours, MM is minutes, SS is seconds, and hh is hundredths of a second. You usually do not have to type all of that in, though; for example, if you are concerned only with seconds, you don't have to type in anything about hours, minutes, or hundredths of seconds.

The Sequence Editor also uses this same format whenever it displays a length of time to you.

The following examples show how to specify various lengths of time:

Length of Time	Format
Ten seconds	10
Ten and 37/100 seconds	10.37
Three minutes and ten seconds	3:10
Three minutes, ten and 37/100 seconds	3:10.37
Seven hours, three minutes, and ten seconds	7:03:10
Seven hours, three minutes, ten and 37/100 seconds	7:03:10.37

5.3.4 The Menu Bar

The [Light-O-Rama Sequence Editor's](#) menu bar gives access to a variety of different functionality. For detailed help, please refer to the help pages for each individual menu on the menu bar:

- The [File menu](#)
- The [Edit menu](#)
- The [View menu](#)
- The [Tools menu](#)
- The [Play menu](#)
- The [Window menu](#)
- The [Help menu](#)

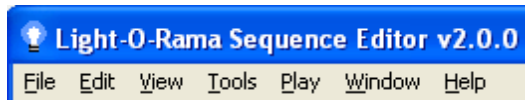

The Sequence Editor's menu bar

5.3.4.1 The File Menu

The [Light-O-Rama Sequence Editor's](#) File menu has menu items related to things like creating, opening, and saving [sequences](#).

Several of these menu items operate on the "currently selected sequence". Many sequences can be open simultaneously in the Sequence Editor, but only one is the currently selected sequence. It is distinguished by its bright blue title bar (as opposed to the pale blue title bar of unselected sequences). To select a sequence, simply click on its window.

- [New](#)
- [Open](#)
- [Open Recent](#)
- [Close](#)
- [Close All Files](#)
- [Close All Files Except This](#)
- [Revert to Saved](#)
- [Save](#)
- [Save As](#)
- [Export as Protected](#)
- [Exit](#)

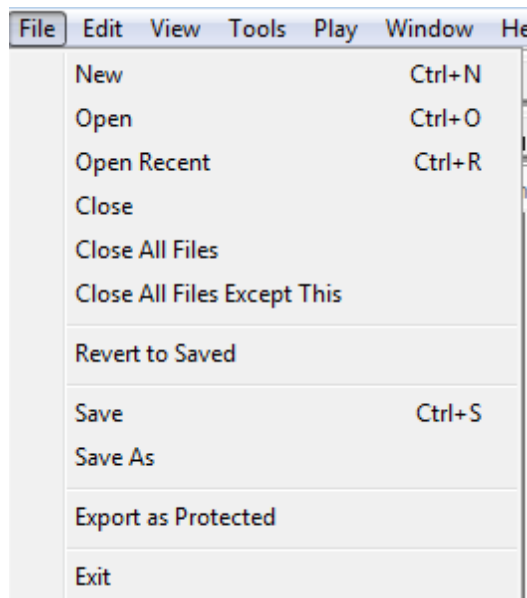

The Sequence Editor's File menu

New

Selecting "New" on the [Sequence Editor's File menu](#) opens the [New and Open dialog](#), on its "[New](#)

[Sequence](#)" tab, which gives a choice between creating a new [animation sequence](#) or a new [musical sequence](#).

"New" has a keyboard hotkey: Ctrl-N.

Open

Selecting "Open" on the [Sequence Editor's File menu](#) opens the [New and Open dialog](#), on its "[Existing Sequence](#)" tab, which lets you open an existing sequence using a file browser similar to Windows Explorer.

"Open" has a [keyboard](#) hotkey: Ctrl-O.

Open Recent

Selecting "Open Recent" on the [Sequence Editor's File menu](#) opens the [New and Open dialog](#), on its "[Recent Sequence](#)" tab, which lets you open by selecting it from a list of the most recently opened sequences.

"Open Recent" has a [keyboard](#) hotkey: Ctrl-R.

Close

Selecting "Close" from the [Sequence Editor's File menu](#) closes the currently selected [sequence](#).

If the sequence has unsaved changes, you will be prompted on whether you wish to save the changes or not; if the sequence has never been saved before, and you choose to save it, you will also be prompted to select a filename for the new sequence.

Close All Files

Selecting "Close All Files" from the [Sequence Editor's File menu](#) closes all open [sequences](#).

If any of the sequences have unsaved changes, you will be prompted on whether you wish to save them or not; if any of the sequences have never been saved before, and you choose to save them, you will also be prompted to select filenames for the new sequences.

Close All Files Except This

Selecting "Close All Files Except This" from the [Sequence Editor's File menu](#) closes all open [sequences](#) *except* the currently selected sequence.

If any of the the sequences being closed have unsaved changes, you will be prompted on whether you wish to save the changes or not; if a sequence being closed has never been saved before, and you choose to save it, you will also be prompted to select a filename for the new sequence.

Revert to Saved

Selecting "Revert to Saved" from the [Sequence Editor's File menu](#) reloads the currently selected [sequence](#) from its last save. Any changes made to the sequence since the last save will be lost.

Save

Selecting "Save" from the [Sequence Editor's File menu](#) saves the changes that you have made to the currently selected [sequence](#). If the sequence was newly created and has never been saved before, Save will also prompt you for a filename to use for the new sequence.

Save has a keyboard hotkey: Ctrl-S.

Save As

Selecting "Save As" from the [Sequence Editor's File menu](#) saves the current [sequence](#) to a new filename. The old file will still exist, but will not include any of the changes that you made to the sequence since the last time that you saved it.

Export as Protected

Selecting "Export as Protected" from the [Sequence Editor's File menu](#) can be used to create a [protected sequence](#) based upon the current [sequence](#).

Exit

Selecting "Exit" from the [Sequence Editor's File menu](#) closes the Sequence Editor. If any currently open sequences have changes that have not yet been saved, you will be prompted for whether or not you want to save them.

5.3.4.1.1 The New and Open Dialog

The [Sequence Editor's](#) New and Open dialog is used to create new [sequences](#), or to open existing sequences. It has three tabs:

- "[New Sequence](#)", to create a new [musical sequence](#) or a new [animation sequence](#);
- "[Existing Sequence](#)", to open an existing sequence, using a file browser similar to Windows Explorer;
- "[Recent Sequence](#)", to open a sequence that had recently been opened, by selecting it from a list.

While the New and Open dialog is displayed, you can change the selected tab by hitting Control-Tab (to cycle forward through the tabs) or Control-Shift-Tab (to cycle backward), or simply by mouse clicking on the desired tab.

The New and Open dialog can be opened, on the appropriate tab, via the [File menu's](#) "[New](#)", "[Open](#)", or "[Open Recent](#)" menu items, and also via the Standard Toolbar's "New Sequence" and "Open Sequence" buttons.

Also, by default, the New and Open dialog will open whenever the Sequence Editor is started (opening on the tab that had been used the last time the dialog was used). This behavior can be suppressed by checking the "Don't show this screen when Light-O-Rama starts" checkbox. If you have suppressed it, and want to unsuppress it, simply uncheck the box the next time that you use the New and Open dialog.

New Sequence

The [New and Open dialog's](#) New Sequence tab allows you to create a new [musical sequence](#) or a new [animation sequence](#). Simply select which you want, which will cause either the [New Musical Sequence dialog](#) or the [New Animation dialog](#) to open.

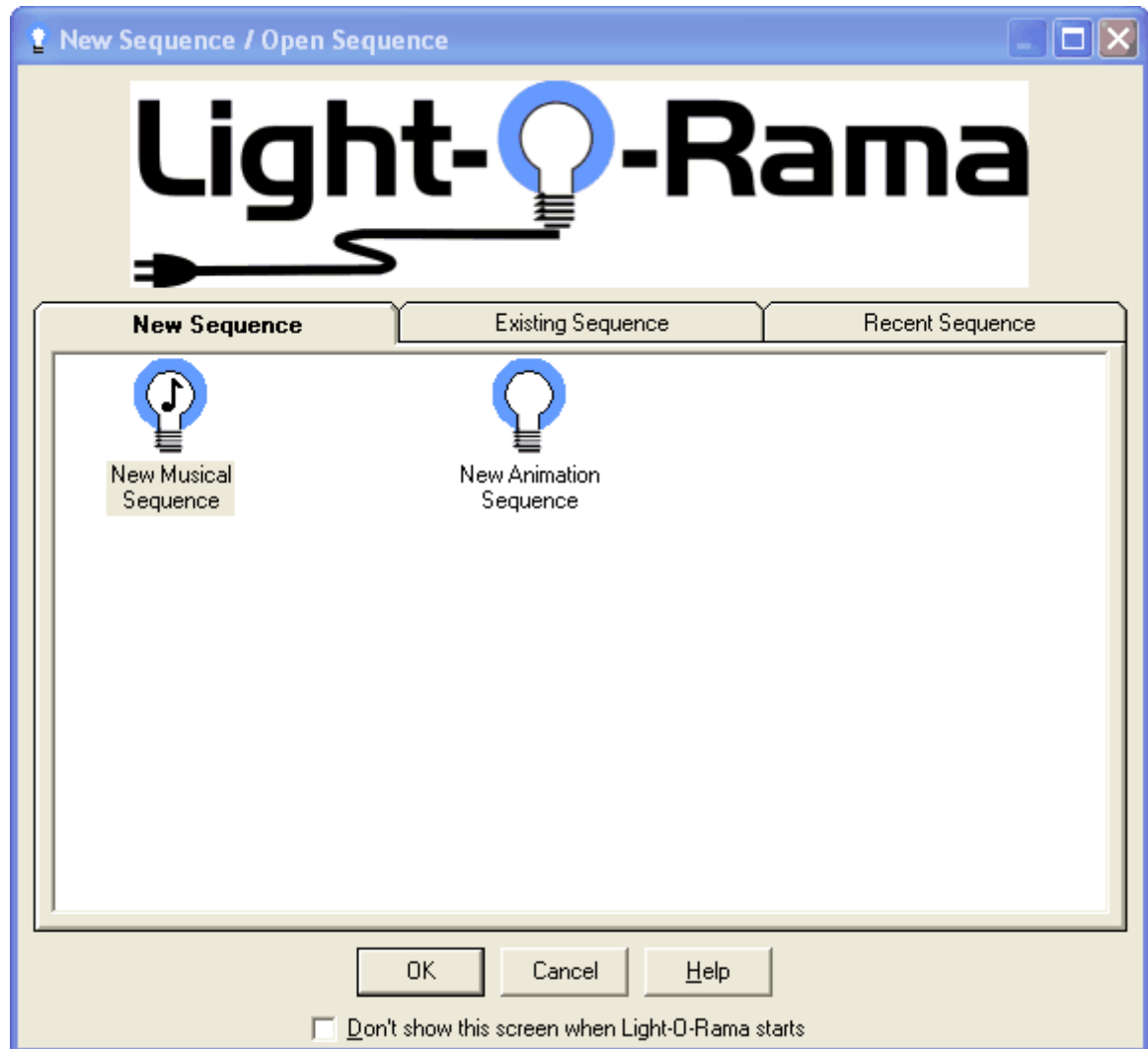

The New and Open dialog's "New Sequence" tab

Existing Sequence

The [New and Open dialog's](#) Existing Sequence tab lets you choose a [sequence](#) to open, using a file browser similar to Windows Explorer.

This also allows you to [import sequences that were created using the Dasher program](#). Simply select the Dasher sequence, and you will be prompted on how you wish to import it.

The "Search for files named" box, below the list of files, causes the list to show only those files with the specified text somewhere in their name. It also supports three wildcard characters, "*", "?" and "#", meaning "zero or more characters", "exactly one character", and "exactly one digit",

respectively.

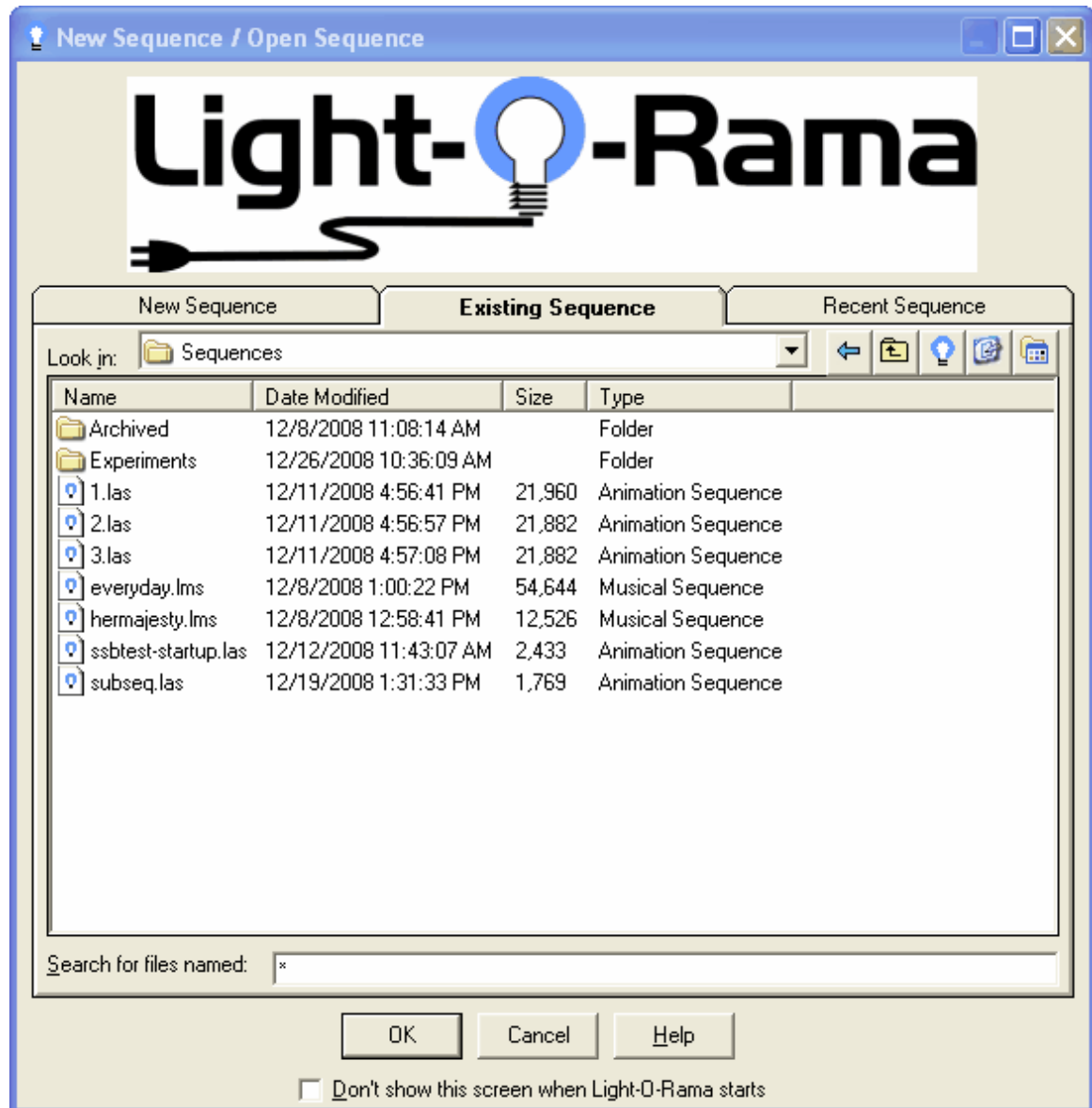

The New and Open dialog's "Existing Sequence" tab

Recent Sequence

The [New and Open dialog's](#) Recent Sequence tab lets you choose a [sequence](#) to open from a list of the sequences which had been opened the most recently.

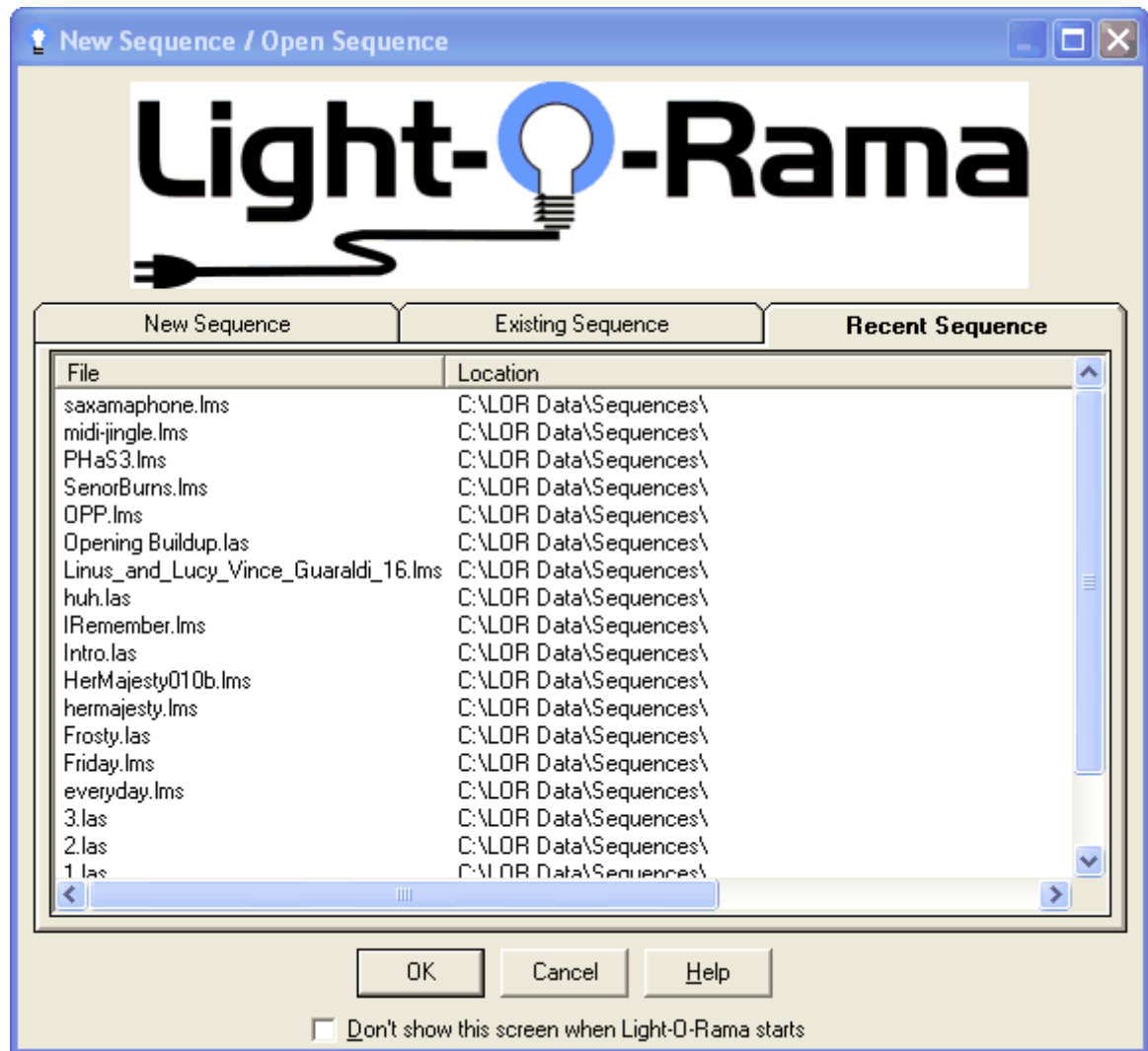

The New and Open dialog's "Recent Sequence" tab

5.3.4.1.2 The New Animation Dialog

The [Sequence Editor's](#) New Animation dialog is used to create a new [animation sequence](#). The New Animation dialog is opened by selecting "New Animation Sequence" from the [New and Open dialog's](#) "New Sequence" tab. The New and Open dialog, in turn, can be opened in a few ways:

- Selecting "New" from the [File menu](#);
- Clicking the "New Sequence" button on the [Standard toolbar](#);
- Using the [keyboard](#) shortcut Ctrl-N.

For detailed help, please refer to the following sections:

- [Who is the author of this new animation?](#)
- [How many channels should this animation use?](#)
- [Automatically set up channels to use standard LOR controllers](#)
- [How long should this animation be?](#)
- [How much time should be in between timings?](#)
- [Use a fixed timing grid](#)

- [Use loops.](#)
- [Save these choices as defaults.](#)
- [Don't ask me this again.](#)

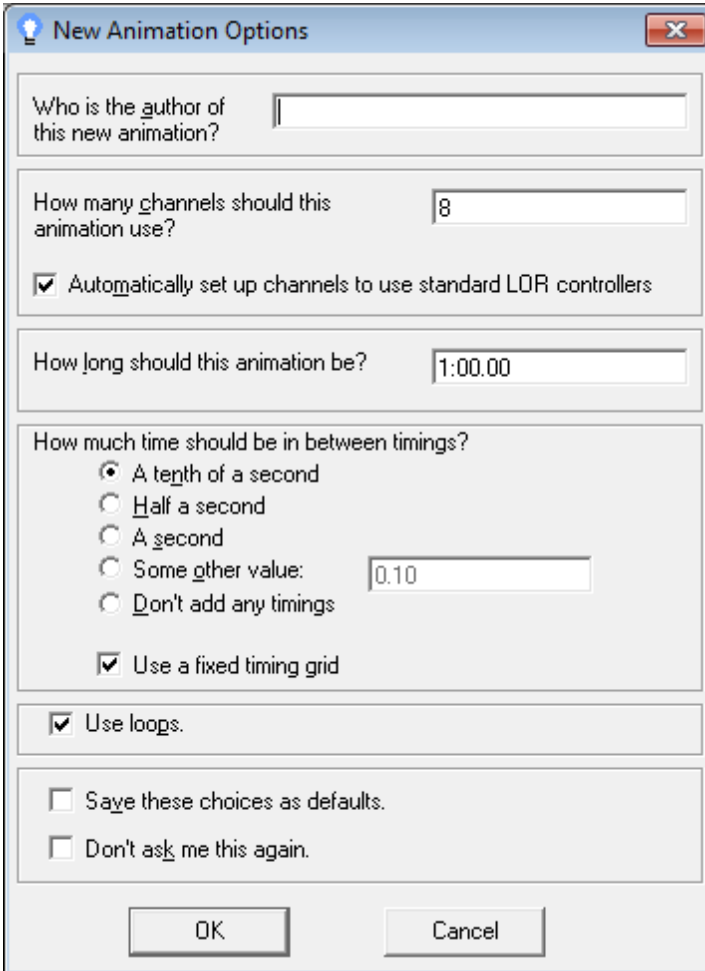

The New Animation dialog

Who is the author of this new animation?

If you wish, you can put your name here. It will be saved with the [sequence](#), and will be displayed as a part of the information available via "[Sequence Info](#)" of the [View menu](#).

Once set, even if set to a blank value, this cannot be changed.

How many channels should this animation use?

Specify the number of [channels](#) that you want in this sequence. You can always change this later, by adding or removing channels, for example via the [Channel Configuration screen](#) or via a [channel's right-click popup menu](#).

Note: All channels specified here will be placed into a single [track](#). More tracks can be added later, for example via [Add New Track](#) or [Duplicate Track](#) of the [Edit menu](#).

Automatically set up channels to use LOR controllers

If you check this box, the [channels](#) in your newly created [sequence](#) will automatically be set up to use [Light-O-Rama controllers](#). The first channel will be set up to use [unit 1 circuit 1](#), the next unit 1 circuit 2, and so forth, up through unit 1 circuit 16, and then on to unit 2, and so forth. All such channels will be set up to use the regular [LOR network](#).

How long should this animation be?

This allows you to specify the duration of the [sequence](#). You will be able to change the value later, using "[Change Total Time](#)" in the [Edit menu](#).

The time can include hours, minutes, seconds, and hundredths of a second. For details on the format used to specify various lengths of time, please see [Time Format](#).

How much time should be in between timings?

This allows you to tell the [Sequence Editor](#) to automatically insert [timings](#) into the new [sequence](#). Timings are the spots in time where you can easily place [lighting effects](#) - for example, turn a string of lights [on](#), or have it [twinkle](#), or have it [fade down](#).

If you don't know how far apart you want timings to be, just take a guess. You can always insert, delete, or move timings later. Note that although the New Animation dialog only allows you to set timings up at equal lengths from each other, timings in general can be any length from each other. For example, you could later add a timing three seconds away from another, and a third timing half a second away from that one.

If you select "Some other value", you can enter any length you want, rather than one of the defaults. For details on the format used to specify various lengths of time, please see [Time Format](#).

Use a fixed timing grid

Unless you chose "Don't add any timings" in response to the question "[How much time should be in between timings?](#)", then if this box is checked, the [sequence's](#) initial [timing grid](#) will be a [fixed timing grid](#). Otherwise, it will be a [freeform timing grid](#).

Use loops.

If you check the "Use Loops" checkbox, the newly created [sequence](#) will automatically include a loop level, which can be used to insert [loops](#) into the sequence.

If you create an [animation sequence](#) without having selected "Use Loops", and you later decide that you do want loops in the sequence, you can add a loop level by selecting "[Turn on Loops](#)" from the [Edit menu](#).

Save these choices as defaults.

If you turn this checkbox on, your answers to the questions in this dialog will be saved so that whenever you create a new [animation sequence](#) in the future, those answers will automatically show up in this dialog as the default answers.

Don't ask me this again.

If you turn this checkbox on, then whenever you create new [animation sequences](#) in the future, you will not be presented with this dialog. Instead, the default answers to the questions will be used.

If you later decide that you want to change these defaults, you can do so by going to the [New Animation Preferences dialog](#), from [Preferences submenu](#) of the [Edit menu](#).

5.3.4.1.3 The New Musical Sequence Dialog

The [Sequence Editor's](#) New Musical Sequence dialog is used to create a new [musical sequence](#). The New Musical Sequence dialog is opened by selecting "New Musical Sequence" from the [New and Open dialog's](#) "New Sequence" tab. The New and Open dialog, in turn, can be opened in a few ways:

- Selecting "New" from the [File menu](#);
- Clicking the "New Sequence" button on the [Standard toolbar](#);
- Using the [keyboard](#) shortcut Ctrl-N.

After doing one of these things, but before the New Musical Sequence dialog opens, you will be prompted to select the audio or video file that you want to build the new [sequence](#) based off of. After you select such a file, then the New Musical Sequence dialog will open.

For detailed help, please refer to the following sections:

- [Author of this new sequence](#)
- [Musical Information](#)
- [Channel Setup](#)
- [Initial Timing](#)
- [Save as defaults.](#)
- [Don't ask me this again.](#)

The New Musical Sequence dialog

Author of this new sequence

If you wish, you can put your name here. It will be saved with the [sequence](#), and will be displayed as a part of the information available via "[Sequence Info](#)" of the [View menu](#).

Once set, even if set to a blank value, this cannot be changed.

Musical Information

If you wish, you can put the name of the artist, song, and album of the associated song here. It will be saved with the [sequence](#), and will be displayed as a part of the information available via "[Sequence Info](#)" of the [View menu](#).

If you are basing the sequence on an MP3 file, and the file is tagged with this information, it will automatically be placed into this section (though you can still change or delete it if you wish).

You can change this information later, via "[Sequence Info](#)" of the [Edit menu](#).

Channel Setup

In this section, you can either specify the number of [channels](#) that you want in this sequence, or specify that the channels should be set up based upon a [channel configuration file](#).

If you specify the number of channels, you can also check the "Using standard LOR controllers" checkbox, which will cause the channels in the new sequence to be automatically set up to use [Light-O-Rama controllers](#). The first channel will be set up to use [unit 1 circuit 1](#), the next unit 1 circuit 2, and so forth, up through unit 1 circuit 16, and then on to unit 2, and so forth. All such channels will be set up to use the regular [LOR network](#).

Unless you use a channel configuration file, all channels specified here will be placed into a single [track](#). More tracks can be added later, for example via [Add New Track](#) or [Duplicate Track](#) of the [Edit menu](#).

You can always change the number of channels or their settings later, by adding or removing channels, for example via the [Channel Configuration screen](#) or via a [channel's right-click popup menu](#).

Initial Timing

This allows you to tell the [Sequence Editor](#) to automatically insert [timings](#) into the new [sequence](#). Timings are the spots in time where you can easily place [lighting effects](#) - for example, turn a string of lights [on](#), or have it [twinkle](#), or have it [fade down](#).

In addition to placing timings a certain length of time apart (a tenth of a second, a half second, a second, or "some other value"), add adding no timings at all ("Don't add any timings"), you can instruct the Sequence Editor to use various wizards to insert timings based upon the song itself:

- The [MIDI Wizard](#) can insert timings and effects based upon the beat of a MIDI song, as well as based on the individual notes played by different instruments in the song.
- The [Tapper Wizard](#) allows you to tap the keyboard or mouse while the song plays, and will record the times at which you tap.
- The [Beat Wizard](#) attempts to determine the tempo of the song, and insert timings and effects based upon it.
- The [VU Wizard](#) looks for peaks in the song, much like a VU meter, and inserts timings and effects based upon them.

Not all of these wizards are available for every type of media file; for example, the MIDI Wizard can only be used with MIDI files. Any wizards that cannot be used with the type of media file being used will be greyed out.

If you select "Some other value", you can enter any length you want, rather than one of the defaults. For details on the format used to specify various lengths of time, please see [Time Format](#).

If you choose to have equally spaced timings, then you will be given the option to use a [fixed timing grid](#) or a [freeform timing grid](#), by checking or unchecking the "Use a fixed timing grid" box. Otherwise, a freeform timing grid will be used.

Note that you can always insert, delete or move timings later, in a variety of ways.

Save as defaults.

If you turn this checkbox on, your answers to most of the questions in this dialog will be saved so that whenever you create a new [musical sequence](#) in the future, those answers will automatically show up in this dialog as the default answers.

The [Musical Information](#) section - i.e. the artist name, album name, and song name - will not be saved as defaults (though if you use an MP3 tagged with this information, it will automatically be placed into that section).

Don't ask me this again.

If you turn this checkbox on, then whenever you create new [musical sequences](#) in the future, you will not be presented with this dialog. Instead, the default answers to the questions will be used.

If you later decide that you want to change these defaults, you can do so by going to the [New Musical Sequence Preferences dialog](#), from [Preferences submenu](#) of the [Edit menu](#).

5.3.4.2 The Edit Menu

The [Light-O-Rama Sequence Editor's](#) Edit menu contains menu items that let you modify [sequences](#) in a variety of ways, as well as to set your preferences for the behavior of the Sequence Editor.

Most of these menu items apply to the currently selected sequence, or to the active [track](#) of the currently selected sequence. There can be many sequences open in the Sequence Editor simultaneously, but only one is the currently selected sequence. It can be distinguished by its bright blue title bar (as opposed to the pale blue title bar of unselected sequences). You can select a sequence simply by clicking on its window.

- [Undo and Redo](#)
- [Enable/Disable Undo Recording](#)
- [Cut, Copy, Paste, and Paste Multiple](#)
- [Set Paste Mode](#)
- [Copy and Paste Timings](#)
- [Select Columns, Select Rows, and Select All](#)
- [Change Track Name](#)
- [Skew Track](#)
- [Add New Track](#)
- [Duplicate Track](#)
- [Change Total Time](#)
- [Timings](#)
 - [Insert Multiple Timings](#)
 - [Subdivide Timings](#)
 - [Delete Extraneous Timings](#)
 - [Lock Timings](#)
 - [Drag Events with Timings](#)
 - [Confirm Long Timing Drags](#)
- [Turn on Loops](#)
- [Sequence Info](#)
- [Media File](#)
- [Windows Command](#)
- [Export and Import Channel Configuration](#)

- [Preferences](#)

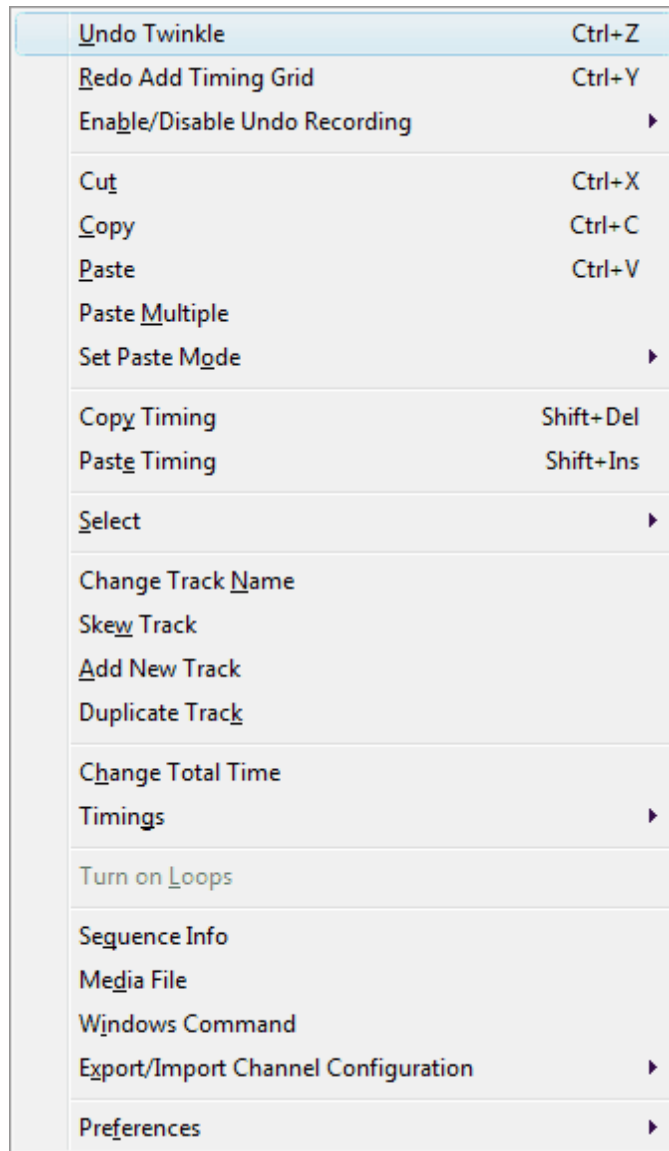

The Sequence Editor's Edit menu

Undo and Redo

These allow you to undo and redo changes that you make to a [sequence](#). A wide variety of changes can be undone and redone - changing [lighting effects](#), moving [timings](#), inserting [channels](#), and many more. The next change to be undone or redone is named in the menu item:

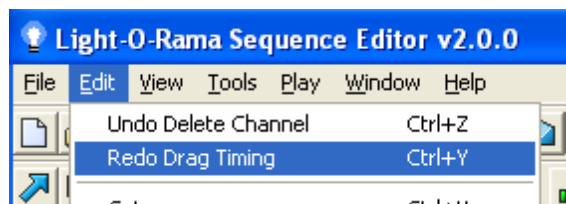

The next items to be undone or redone are named on the menu

There is a limit to how many changes will be remembered for the purposes of undo and redo, so if you make many changes to a sequence and then start undoing them all, you may eventually reach a point where you can't undo any more, even though you haven't undone all of the changes that you made.

Also, you will not be able to undo any changes made before the last time that you saved the sequence.

A related option is to use "[Revert to Saved](#)" from the [File menu](#). This will reload the sequence as it was the last time that you saved, getting rid of all changes since that time.

Undo and redo have [keyboard](#) hotkeys: Ctrl-Z and Ctrl-Y, respectively.

Enable/Disable Undo Recording

Certain very large operations in the [Sequence Editor](#) could take a very long time to do. For example, [skewing](#) a [track](#) involves changing all of the [timings](#), [effects](#), and [loops](#) in the track; in a large [sequence](#) with many [channels](#), this could take a prohibitively long time. Much of the time spent is actually due to recording the changes so as to later be able to [undo and redo](#) them.

For situations like this, you can disable undo recording before making such a change, which will speed up how long the change will take. You will not be able to undo any changes after doing so (except for changes that you make after re-enabling it later), so it is strongly suggested that you save your sequence before disabling undo recording.

Cut, Copy, Paste, and Paste Multiple

When editing a [sequence](#), you can select an area [using your mouse](#) or [keyboard](#), and cut or copy the [lighting effects](#) in that area. You can then paste the contents of that area to another spot - even to a spot within a different sequence. Note that this copies only the lighting effects, not the [timings](#) - see "[Copy and Paste Timings](#)" for how to copy timings.

"Paste Multiple" allows you to paste the cut or copied events multiple times in a row - even to the end of the sequence:

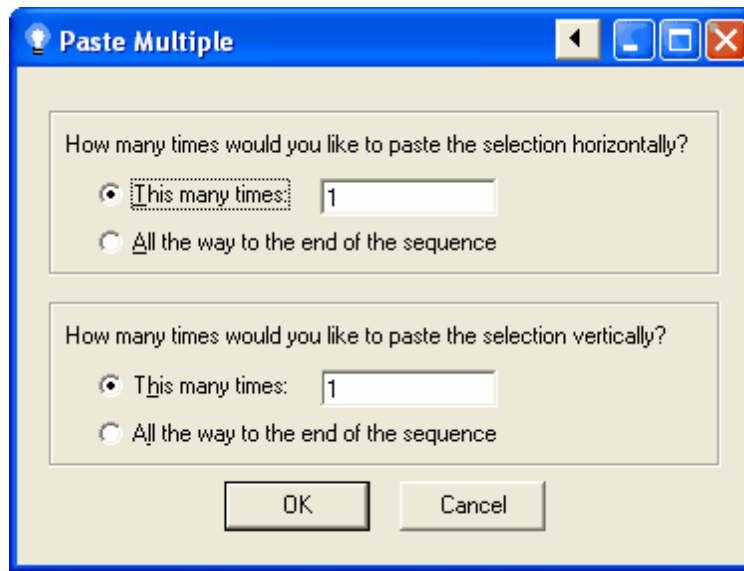

The Paste Multiple dialog

The [Sequence Editor](#) supports four different pasting modes - "[paste by time](#)", "[paste by cell](#)", "[repeat to fit](#)" and "[stretch to fit](#)" - and a pasting option, "[paste from foreground](#)". Which of these is selected will affect how the pasted effect events will look.

Cut, copy, and paste have keyboard hotkeys: Ctrl-X, Ctrl-C, and Ctrl-V, respectively.

Set Paste Mode

When a set of [lighting effects](#) is copied (or cut) in the [Sequence Editor](#), it can be pasted in several different manners: "[paste by cell](#)", "[paste by time](#)", "[stretch to fit](#)", and "[repeat to fit](#)". You can control which paste mode is used via the "Set Paste Mode" submenu of the [Edit menu](#), or via the [Clipboards subpanel](#) of the left-hand Tools panel.

There is also a pasting option, "[paste from foreground](#)". This can be also controlled via "Set Paste Mode" or the Clipboards subpanel.

Copy and Paste Timings

You can select a set of [timings using the keyboard](#) or the [mouse](#), and use "Copy Timing" to copy them. After that, you can paste the timings to another point in the [sequence](#) (or even to another sequence) using "Paste Timing". Note that this copies only the timings, not any [lighting effects](#) (see "[Cut, Copy, Paste, and Paste Multiple](#)" for information on copying lighting effects).

For example, if you copy timings that are at 3 seconds, 3.5 seconds, and 5 seconds, and paste those timings starting at 7 seconds, you will wind up with timings at 7 seconds, 7.5 seconds, and 9 seconds.

Paste Timing allows you to optionally choose to paste the timings multiple times in a row:

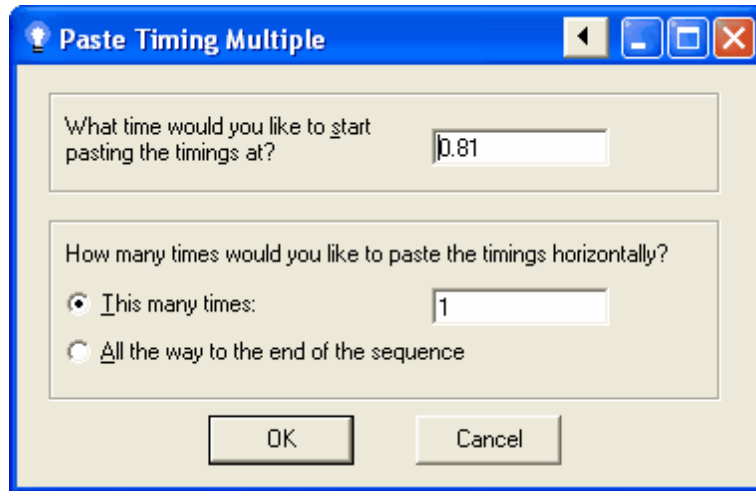

The Paste Timing Multiple dialog

You can also copy and paste timings via the [right-click context menu](#), in a few ways. Depending on the situation, using one of them may be more convenient than doing so via the [Edit menu](#). For example, [one of the options](#) on that menu allows you to paste the timings once to the exact spot that you right-clicked on, getting rid of the need for the Paste Timing Multiple dialog.

Copy Timing and Paste Timing have keyboard hotkeys: Shift-Del and Shift-Ins, respectively.

Select Columns, Select Rows, and Select All

These menu items allow you to select an entire column or set of columns (representing time) or an entire row or set of rows (representing [channels](#)), or both.

You can also [select columns](#) or [rows](#) from the [right-click context menu](#).

Change Track Name

[Tracks](#) can optionally be given names. They can be set when the track is created, or via this menu item. The track's name (if any) will be displayed on its [track bar](#), among other places.

Skew Track

Skewing a [track](#) will move all of its [events](#), [timings](#), and [loops](#) by some specified amount of time. A track can be skewed either to the left - i.e. shifting its events (and such) earlier in time - or to the right - i.e. shifting them later in time.

After selecting "Skew Track" from the [Edit menu](#), a window will open up, allowing you to choose the size and direction of the skewing:

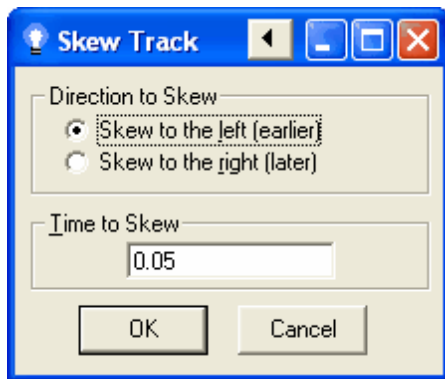

The Skew Track dialog

After completing this dialog, the active track will be skewed by the amount, and in the direction, that you chose.

Here is an example of a simple sequence, before and after skewing to the left by one-quarter second:

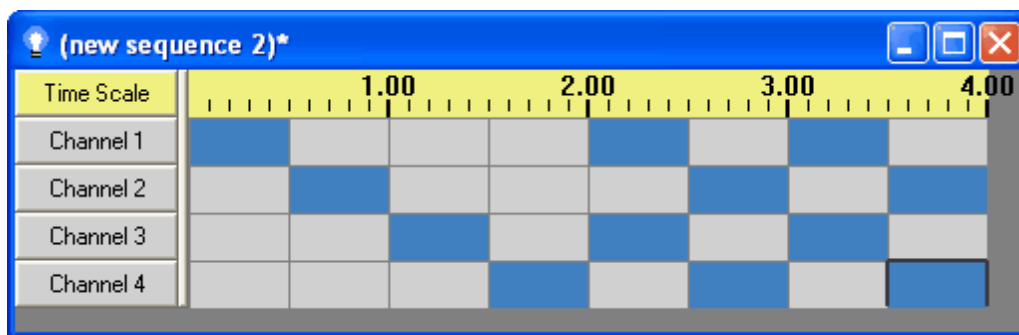

A simple sequence, before skewing

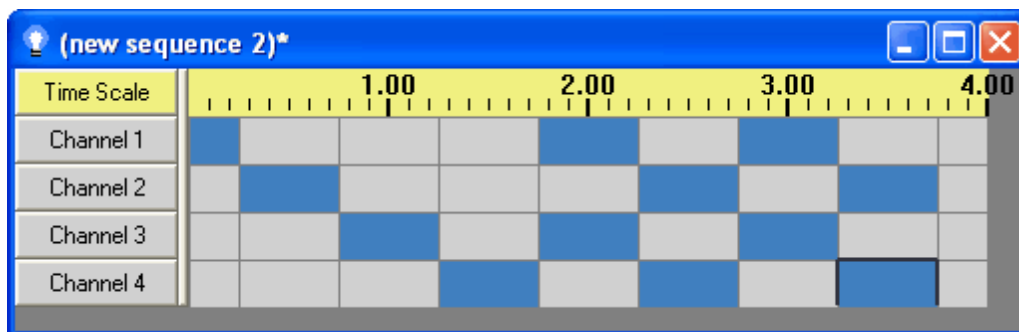

The same track, after skewing to the left by 1/4 second

Add New Track

This menu item allows you to add a new [track](#), with new [channels](#), to a [sequence](#), using the [Add New Track dialog](#).

Tip: To use the same channel in more than one track, do *not* simply set two channels in different tracks to point to the same [hardware controller](#) (i.e. to have the same unit number, circuit number, et cetera). Doing so will likely cause unexpected and undesired results, as the two channels compete

for control over the same circuit. Instead, [copy the channel to a new track](#) or [to an existing track](#). Or, if you want to share all the channels in a track with another track, [duplicate the track](#).

Duplicate Track

This menu item instructs the [Sequence Editor](#) to duplicate all of the [channels](#) in the current [track](#) to a new track. The channels will be shared between the two tracks.

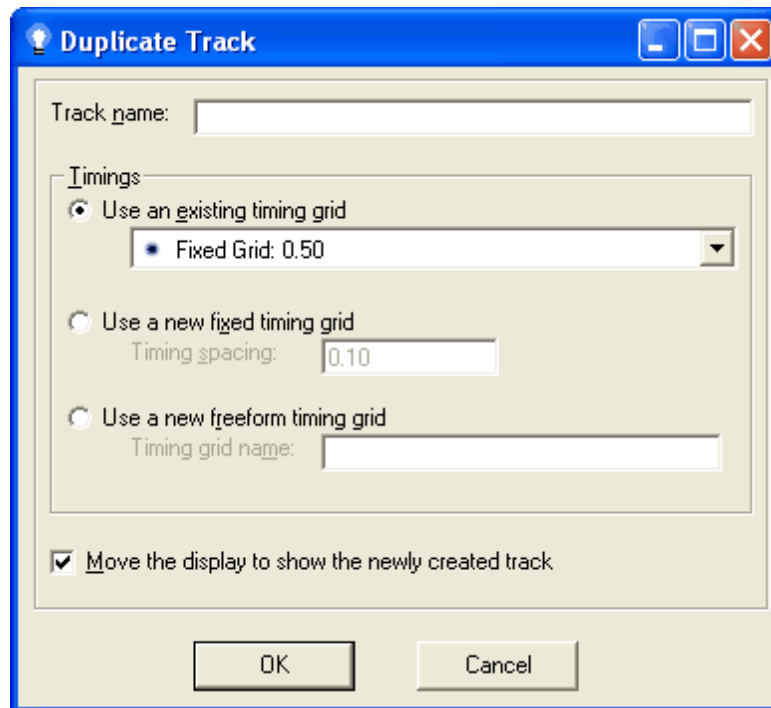

The Duplicate Track dialog

Change Total Time

This menu item allows you to change the duration of the active [track](#). Note that all tracks in a [musical sequence](#) (as opposed to an [animation sequence](#)) must have the same length, so changing the length of one track in a musical sequence will automatically change the length of all of them.

For information on the format used to specify an amount of time, please see [Time Format](#).

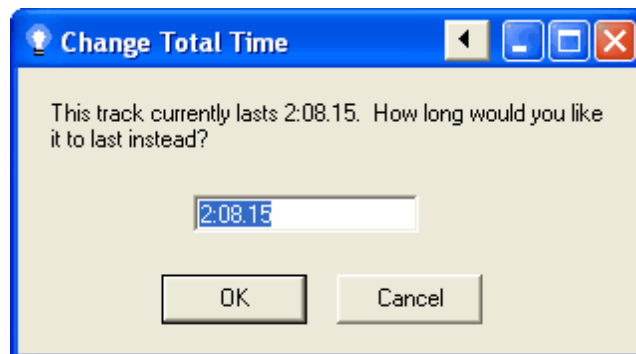

The Change Total Time dialog

Timings

This submenu of the [Sequence Editor's Edit menu](#) has various [timing](#)-related functions:

- [Insert Multiple Timings](#)
- [Subdivide Timings](#)
- [Delete Extraneous Timings](#)
- [Switch Timing Grid](#)
- [Change Timing Grid Name](#)
- [Lock Timings](#)
- [Drag Events with Timings](#)
- [Confirm Long Timing Drags](#)

Insert Multiple Timings

This allows you to insert multiple [timings](#) into the current selection, to divide it into equally-sized parts. For example, if you select an area whose time range is from 6 to 8 seconds, and use "Insert Multiple Timings" to insert three equally spaced timings, then the new timings will be inserted at 6.5, 7, and 7.5 seconds, splitting the selection into four equally spaced parts of half a second each.

See also [Subdivide Timings](#), which divides each selected cell into equally-sized parts, as opposed to dividing the entire selection into equally-sized parts.

Subdivide Timings

This allows you to insert multiple [timings](#) into the current selection, dividing each selected cell into equally-sized parts. For example, if you select three cells, from 2 to 3 seconds, 3 to 3.6 seconds, and 3.6 seconds to 4 seconds, and use "Subdivide Timings" to subdivide into two cells, you will end up with six cells, from 2 to 2.5, 2.5 to 3, 3 to 3.3, 3.3 to 3.6, 3.6 to 3.8, and 3.8 to 4.

See also [Insert Multiple Timings](#), which divides the entire selection into equally-sized parts, as opposed to dividing each selected cell into equally-sized parts.

Delete Extraneous Timings

The purpose of [timings](#) is to allow you to easily select a time range to apply a [lighting effect](#) to. Sometimes, a [sequence](#) winds up having timings which are not necessary for any of the existing lighting effects - for example, everything that was [on](#) before the timing is also on after the timing, everything [twinkling](#) before is also twinkling afterwards, and so forth.

"Delete Extraneous Timings" lets you automatically get rid of all such timings. Deleting these timings is not really necessary - it makes no difference to how your lights will behave - but it may make your sequence easier to understand and to edit by reducing clutter. It may also be useful, for example, when using the [Tapper Wizard's](#) "Snap to Existing Timings" functionality.

The following pictures are a before-and-after of deleting extraneous events. Note that the timing event at one second in the first picture is not necessary - every channel that is on before it is on after it, every one that is twinkling before it is twinkling after it, and so forth. The second picture - after deleting extraneous events - therefore does not have this timing. However, the way that the lights operate will be the same in both cases.

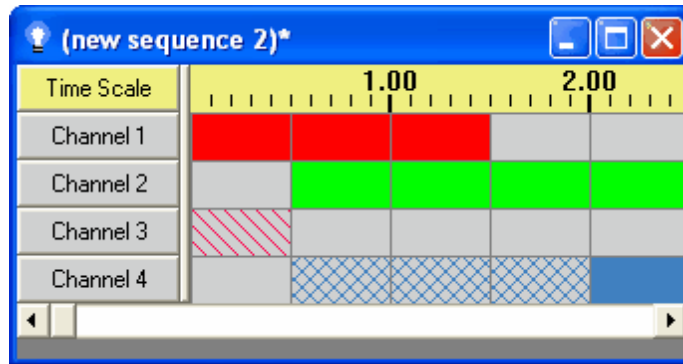

Before deleting extraneous timings

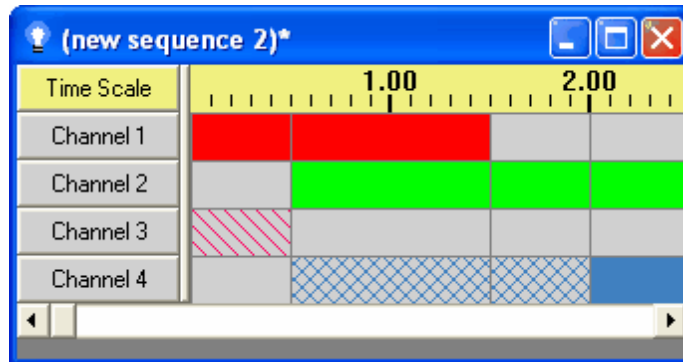

After deleting extraneous timings

Switch Timing Grid

Selecting this menu item opens a dialog window allowing you to switch which [timing grid](#) is currently used by the active [track](#). You can switch to an existing timing grid simply by selecting it from the dropdown list, or switch to a new [fixed](#) or [freeform](#) timing grid, or a new freeform grid with copies of all the [timings](#) in the current grid, by clicking on the appropriate button:



The Switch Timing grid dialog

Change Timing Grid Name

This menu item allows you to change the name of the current [timing grid](#). The main purpose of giving a name to a timing grid is so that they can be easily distinguished when listed in places such

as the [Tracks and Timings toolbar's timings dropdown list](#).

Lock Timings

Each [timing](#) in a [sequence](#) is a particular point in time (since the beginning of the sequence), and is represented by a vertical grey line. If "Lock Timings" is off (unchecked), and the current [timing grid](#) is a [freeform timing grid](#), you can change the time of a timing by hovering over its line with your mouse (which will change your mouse cursor from a "pointer" cursor to an "east-west" cursor), and clicking and dragging the line to the left or the right.

If "Lock Timings" is on (checked), you cannot do this. This prevents you from accidentally changing the time of a timing while you're trying to modify the [lighting effects](#) in a cell between two timings.

See also "[Drag Events with Timings](#)", which controls whether or not effect events that start or end at the dragged timing will be dragged along with it.

Drag Events with Timings

[Timings](#) in a [sequence](#) can be dragged with the mouse to change the time that they are at (unless the [Lock Timings](#) option is turned on). If "Drag Events with Timings" is turned on, and any [effect events](#) start or end at the same time as the timing being dragged, they will be dragged along with it. If not, only the timing will move; the effect events will remain unchanged.

Confirm Long Timing Drags

If you change the time of a [timing](#) by dragging it with your mouse (as described in "[Lock Timings](#)"), and at some point in your drag you went past the previous timing or the next timing, the [Sequence Editor](#) guesses that you might not have actually intended to change the timing's time; rather, you might have accidentally clicked on the timing's line and dragged it while intending to do something else, like modifying the lighting effects near the timing.

In this case, the Sequence Editor will ask if you really want to change the timing, unless you turn off (i.e. uncheck) "Confirm Long Timing Drags", in which case it will simply move the timing without asking.

Turn on Loops

[Animation sequences](#) (but not [musical sequences](#)) can contain [loops](#): When a certain point in the sequence - the end of a loop - is reached during play, play continues at the start of the loop instead of continuing straight through, until the loop has been done a certain number of times (which you can choose).

When an animation sequence is created using the [New Animation dialog](#), you have the option to say that loops will be used in the sequence. Doing so will cause a white "loop level" row to be present above all of the grey "[channel](#)" rows in the sequence.

If you did not choose to use loops in the New Animation dialog, you will not get a loop level row in your sequence. However, if you later decide that you do want to use loops, you can use "Turn on Loops" to add a loop level to the sequence.

Sequence Info

This brings up a dialog displaying various information about the [sequence](#), allowing you to change some of it:

- **Created By:** The creator of the sequence as specified in the [New Animation dialog](#) or the [New Musical Sequence dialog](#). This value cannot be edited.
- **Created At:** The date and time at which the sequence was created. This value cannot be edited.
- **Modified By:** If you modify a file that was created by someone else, you can enter your name here, if you wish.
- **Music Artist:** For [musical sequences](#), the artist who performed the song.
- **Music Title:** For musical sequences, the name of the song.
- **Music Album:** For musical sequences, the name of the album that the song is from.

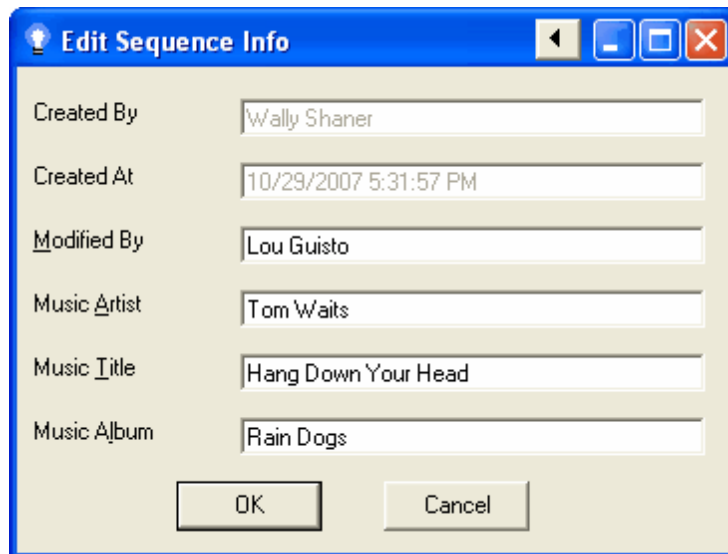

The Edit Sequence Info dialog for a musical sequence

Media File

This menu item allows you to specify the audio or video file that should be used with the current [sequence](#). This may be useful, for example, if you have changed the directory that you store your media files in.

It is available only for [musical sequences](#), not [animation sequences](#).

Windows Command

Selecting "Windows Command" from the [Sequence Editor's Edit menu](#) will open up a dialog allowing you to specify an arbitrary [Windows shell command](#) to be executed whenever the [sequence](#) is run (whether by the Sequence Editor or by the [Show Player](#)). This dialog also allows you to choose how the window for the command will be opened - for example, whether it will be maximized or not.

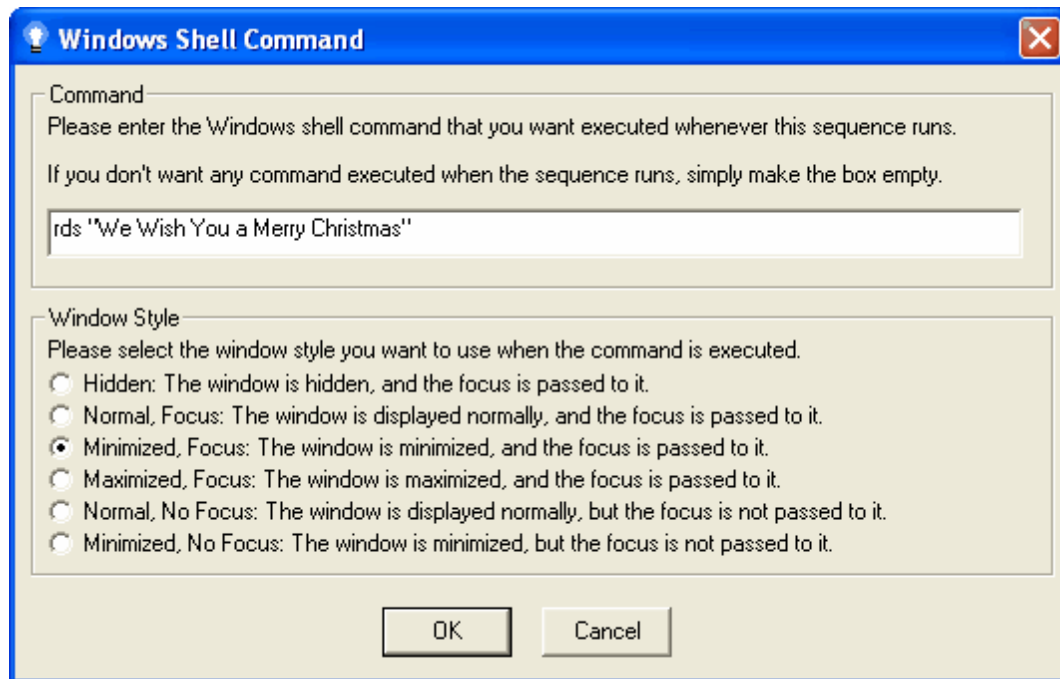

The Windows Shell Command dialog.

Export and Import Channel Configuration

Every [channel](#) in a [sequence](#) has various information associated with it, such as its name, display color, and hardware information such as the unit number of the [controller](#) and the circuit number of the string of lights on that controller.

You can set up this information in various ways, such as via the [Channel Configuration screen](#). However, it may be the case that you often want to do this the exact same way, for several different sequences, using the same channel names, hardware assignments, et cetera. Rather than manually setting it up every time, you can use the Export and Import Channel Configuration menu items.

Once you have the correct channel information set up for a particular sequence, you can choose "Export Channel Configuration" to save the channel information to a channel configuration file. When you create another sequence and you want to use the same controllers and the same circuits, you can simply choose "Import Channel Configuration" and select the channel configuration file that you previously exported to.

The saved channel configuration information also includes the [animation](#) associated with the exported sequence, so you will not have to redraw it every time.

If your exported sequence contains more channels (or [tracks](#)) than the sequence that you are importing to, new channels or tracks will automatically be created in the latter sequence during the import (or, if the channels in a track of the configuration file are copies of channels in earlier tracks of the configuration file, copies of the corresponding channels from the earlier tracks of the sequence will be put into the later tracks of the sequence). On the other hand, if the exported sequence contains less channels (or tracks), the extras in the sequence that you are importing to will simply remain unchanged.

When exporting and importing from and to sequences with more than one track, there are two potential minor side effects:

First, if a track in the sequence contains only channels that are copies of channels in earlier tracks of the sequence, and the channel configuration does not contain a track at the corresponding position, then the track will be removed from the sequence. Note that the channels from the track are *not* removed from the sequence - they are only removed from the track (and, since the track then contains no channels, the track is removed from the sequence). The channels will still be present in earlier tracks of the sequence.

Second, if a track in the sequence contains a channel which is not a copy of a channel of an earlier track in the sequence, and the channel configuration file does not contain a channel at the corresponding position (other than copies of channels from earlier tracks), then the channel will be "pushed down" towards the bottom of the track.

Preferences

The Preferences submenu of the [Edit menu](#) allows you to open various [preference dialogs](#) that affect how the [Sequence Editor](#) will behave:

- [Clipboard Preferences](#)
- [Display Preferences](#)
- [DMX Preferences](#)
- [Holiday Lights Designer Preferences](#)
- [Keyboard Preferences](#)
- [Network Preferences](#)
- [New Animation Preferences](#)
- [New Musical Sequence Preferences](#)
- [Play Preferences](#)
- [Visualizer Preferences](#)
- [Video Preferences](#)
- [Zoom Preferences](#)

For detailed help on each, please refer to their individual help file pages.

5.3.4.2.1 The New Track Dialog

The [Sequence Editor's](#) New Track dialog is used to create a new [track](#) in a [sequence](#). You can open the New Track dialog in a few ways:

- Via "[Add New Track](#)" on the [Edit menu](#). This will create a new track with all new [channels](#).
- Via "[Copy to New Track](#)" on a [channel button's popup menu](#). This will create a new track that shares the selected channel with the old track, and optionally includes new channels as well.
- Via "[Move to New Track](#)" on a channel button's popup menu. This will create a new track, move the selected channel from the old track to the new, and optionally add new channels to the new track as well.

Important Note: If you want a single channel shared by multiple tracks, do *not* simply set up different channels in the different tracks to have the same unit ID, circuit ID, et cetera. Doing so will likely cause unexpected and undesired results, as the different channels vie for control over the same physical string of lights. Instead, copy the channel from one track to another, or [duplicate a track](#) (which shares all channels in it with the new duplicate track).

For detailed help on the New Track dialog, please see the following sections:

- [What is this track's name?](#)
- [How long should this track be?](#)
- [What timings should be used?](#)
- [How much time should be in between timings?](#)
- [Move the display to show the newly created track](#)

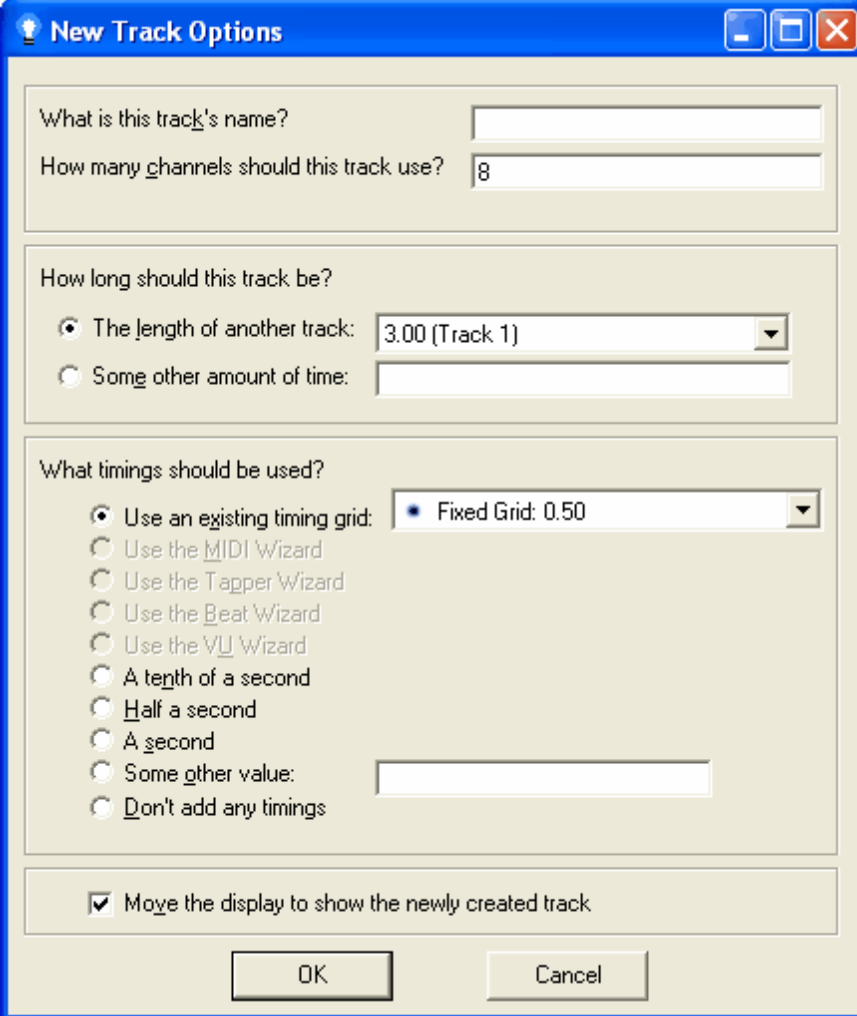

The New Track dialog

What is this track's name?

If you want the [track](#) to have a name, enter it here. The track's name will show up on its track bar, and in various other places where tracks are listed.

If you do not wish to have a track name, you can simply leave this field blank. If you change your mind later, you can always go back and add a name (or change an existing one) by using "[Change Track Name](#)" on the [Edit menu](#).

How long should this track be?

For [animation sequences](#), this allows you to specify the duration of the [track](#). You can choose to use the duration of an existing track, or manually enter a time. For the format used for entering times, please see [Time Format](#).

For [musical sequences](#), this question is greyed out. All tracks in a musical sequence must have the same duration, and so the duration of the new track will automatically be set to the duration of the other tracks in the sequence.

How many channels should this track use?

Use this box to specify the number of new [channels](#) that this track should have.

If you have opened the New Track dialog by copying or moving a channel to a new track, this question will ask you how many channels this track should have *in addition* to the one that you are copying or moving. So, for example, if you want the track only to contain the copied channel, enter "0" in this box.

What timings should be used?

This allows you to instruct the [Sequence Editor](#) to automatically insert [timings](#) into the new [track](#), or else to use an existing [timing grid](#). You can choose from among various preset durations (such as half a second between timings), to manually enter a duration (see [Time Format](#) for how to specify an amount of time), not to insert timings at all, or, for [musical sequences](#), to use various wizards to insert timings or effects based upon the song itself - the [MIDI Wizard](#), the [Tapper Wizard](#), the [Beat Wizard](#), and the [VU Wizard](#). Not all of these wizards will be available for any given sequence - which is available depends upon the type of media file being used.

Note that you can always go back later and add, delete or move timings, in a number of different ways.

Move the display to show the newly created track

If this box is checked, then when the new [track](#) is created, the display will automatically move to show the new track. To get back to the other tracks in your [sequence](#), scroll up.

5.3.4.2.2 Preference Dialogs

The Preferences submenu of the [Edit menu](#) of the [Sequence Editor](#) gives access to various preference dialogs which can be used to control the behavior of the Sequence Editor and other parts of the [Light-O-Rama software package](#):

- [Clipboard Preferences](#)
- [Display Preferences](#)
- [DMX Preferences](#)
- [Holiday Lights Designer Preferences](#)
- [Keyboard Preferences](#)
- [Network Preferences](#)
- [New Animation Preferences](#)
- [New Musical Sequence Preferences](#)

- [Play Preferences](#)
- [Video Preferences](#)
- [Visualizer Preferences](#)
- [Zoom Preferences](#)

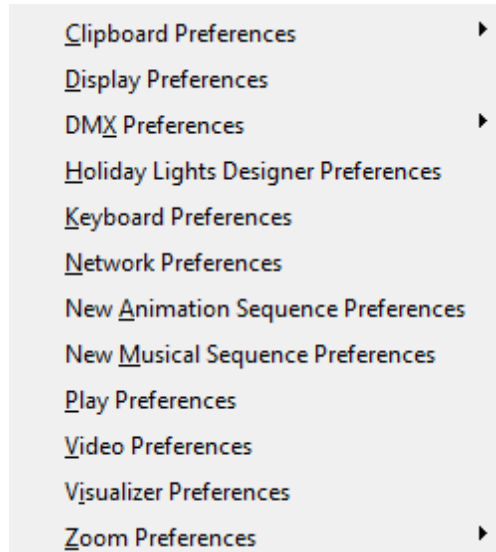

The Preferences submenu of the Sequence Editor's Edit menu

5.3.4.2.2.1 Clipboard Preferences

The Clipboard Preferences menu of the [Preferences submenu](#) of the [Sequence Editor's Edit menu](#) enables you to control certain aspects of [clipboard](#) behavior:

- [Automatically Reload](#)
- [Automatically Resave](#)

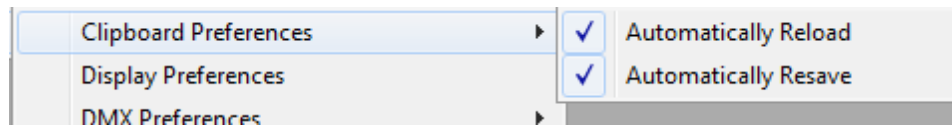

The Clipboard Preferences menu

Automatically Reload

If this menu item in the [Clipboard Preferences](#) menu is checked, then whenever you paste from a saved [clipboard](#), that clipboard's save file will be reloaded so as to pick up any changes to it that may have been made outside of the [Sequence Editor](#).

Automatically Resave

If this menu item in the [Clipboard Preferences](#) menu is checked, then whenever you copy new contents to a saved [clipboard](#), that clipboard will automatically be resaved immediately. If it is unchecked, the changes will not be saved until either you manually save them via the clipboard's popup menu, or until the [Sequence Editor](#) is closed.

5.3.4.2.2.2 Display Preferences

The [Sequence Editor's](#) Display Preferences dialog (which can be opened from the [Preferences submenu](#) of the [Edit menu](#)) gives control over some aspects of how the Sequence Editor looks:

- [General Preferences](#)
 - [View Channel Buttons by Default](#)
 - [View Fades as Ramps by Default](#)
 - [View Time Scale by Default](#)
 - [View Wave Form by Default](#)
- [Tooltip Preferences](#)
 - [Enable tooltips](#)
 - [Seconds before opening](#)
 - [Use Channel Colors](#)
 - [Seconds before closing automatically](#)
 - [Manually close tooltips on mouseover](#)
 - [Manually close tooltips on click](#)
- [Animation Redraw Throttling](#)
- [Advanced OpenGL Settings](#)

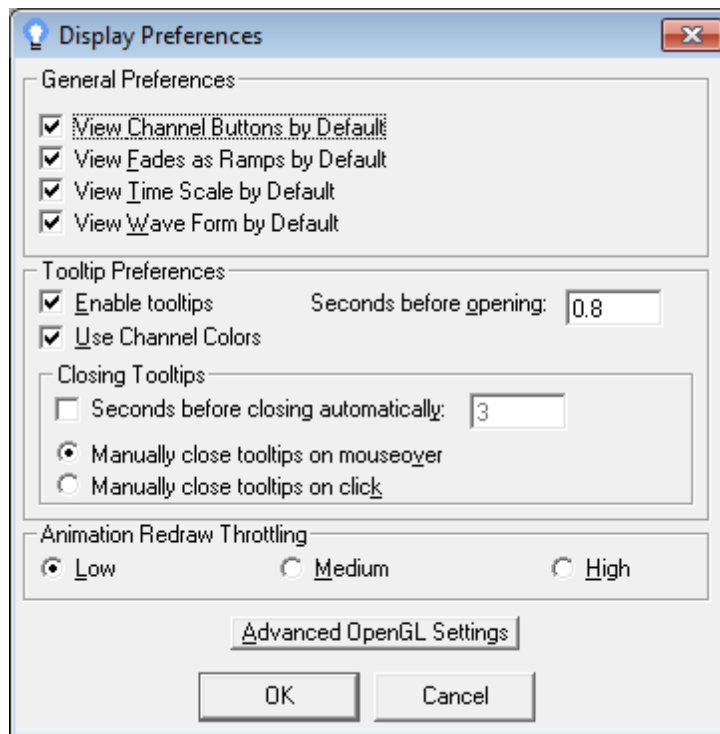

The Display Preferences dialog

General Preferences

- [View Channel Buttons by Default](#)
- [View Fades as Ramps by Default](#)
- [View Time Scale by Default](#)
- [View Wave Form by Default](#)

View Channel Buttons by Default

If this box is checked, the [channel buttons](#) for each [channel](#) in a [sequence](#) will be displayed whenever a sequence is created or opened.

If you don't want to change this default, but want to temporarily change whether or not channel buttons are displayed, you can use "[Channel Buttons](#)" from the [View menu](#), or "[View Channel buttons](#)" from the [Standard toolbar](#), or click on the thick grey vertical bar to the left of the sequence's grid (and, if channel buttons are currently visible, to the right of them).

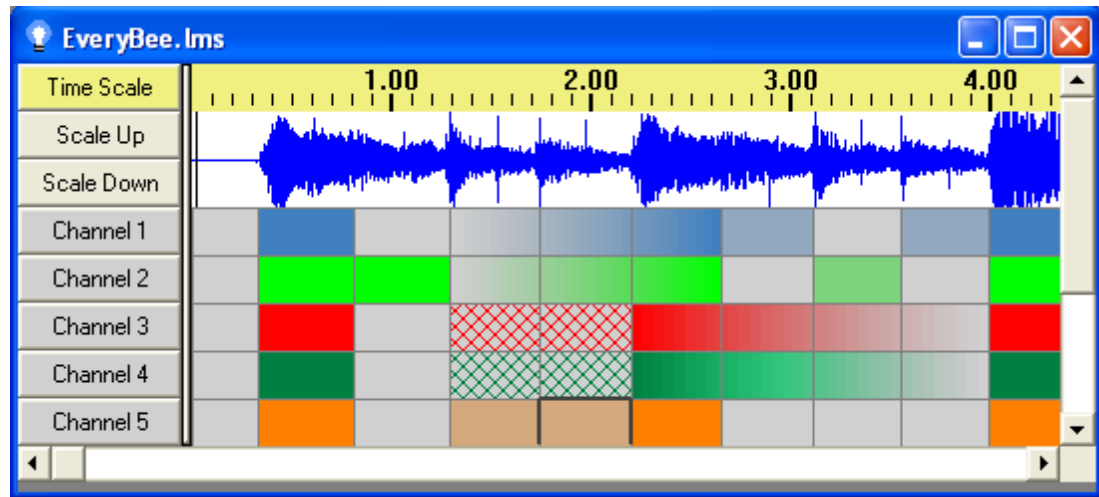

A sequence with channel buttons displayed

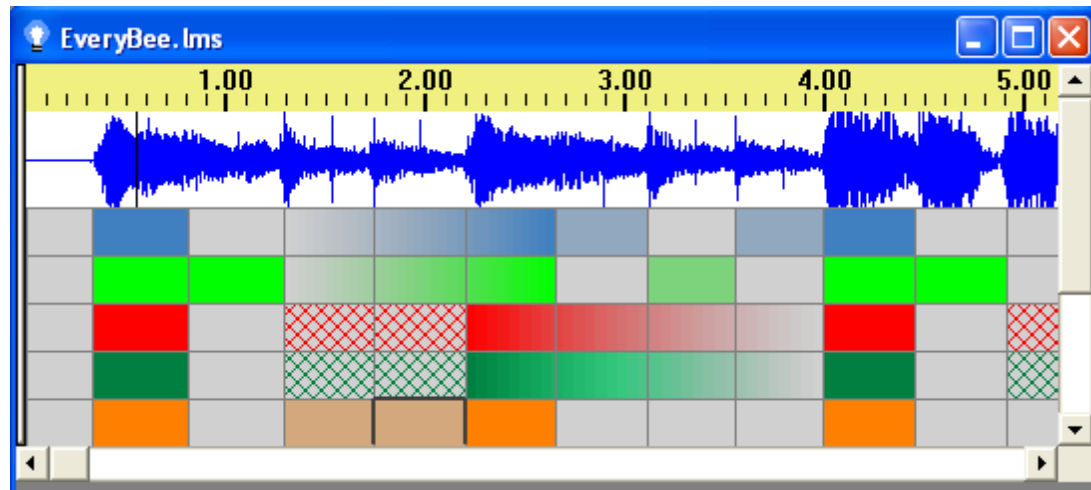

The same sequence, with channel buttons hidden

View Fades as Ramps by Default

If this box is checked, [fades](#) and [intensities](#) will be displayed as ramps by default, whenever a [sequence](#) is opened or created. This means that a cell with a fade or an intensity will be displayed as partially filled in, based upon how bright the fade or intensity is, rather than as shades of the [channel's](#) color.

If you don't want to change this default, but want to temporarily change whether fades are displayed as ramps or as colors, you can use the [Fades submenu](#) of the [View menu](#), or "[View Fades as](#)

[Ramps](#)" from the [Standard toolbar](#).

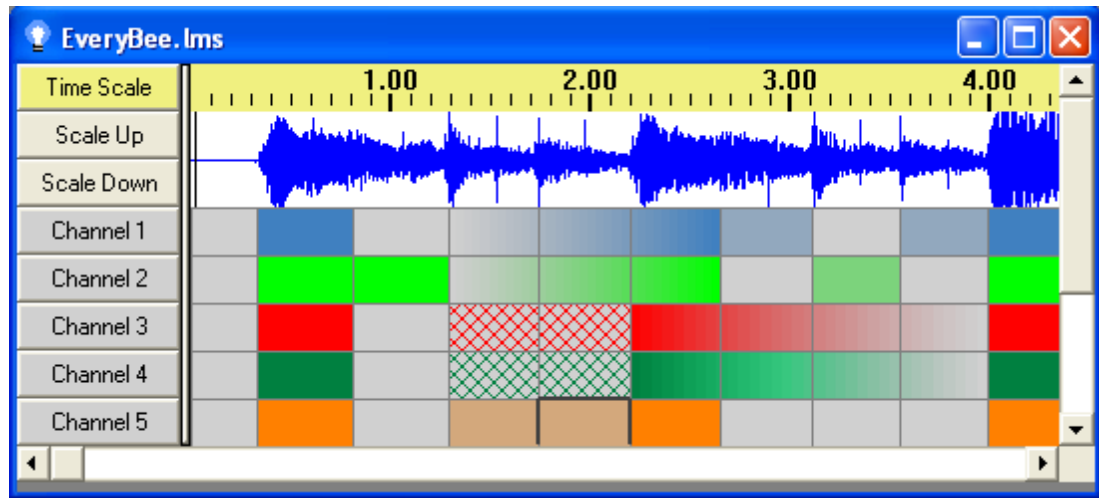

A sequence, with fades displayed using colors

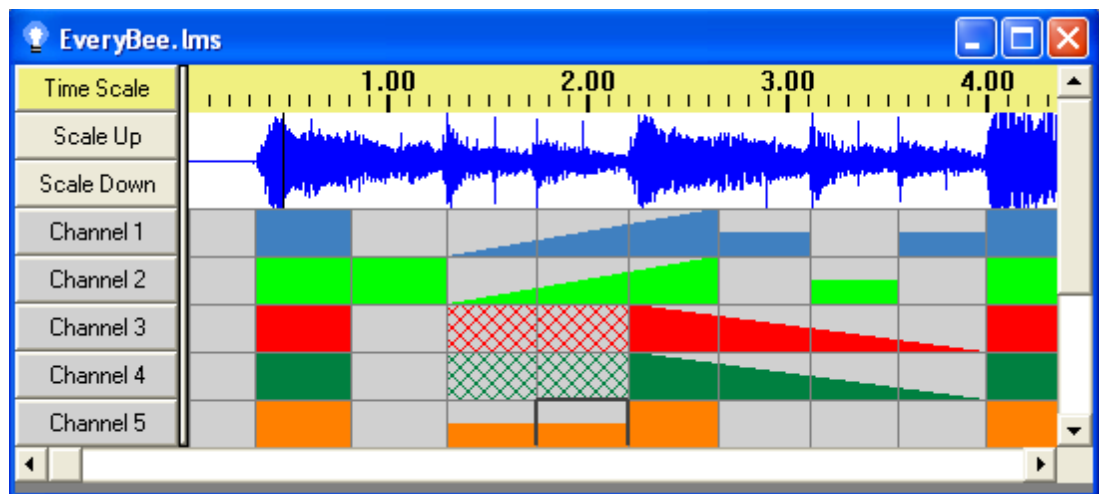

The same sequence, with fades displayed as ramps

View Time Scale by Default

If this box is checked, then whenever a [sequence](#) is created or opened, a time scale will be displayed at the top of the sequence.

If you don't want to change this default, but want to temporarily change whether a time scale is displayed or not, you can use "[Time Scale](#)" from the [View menu](#), or "[View Time Scale](#)" from the [Standard toolbar](#).

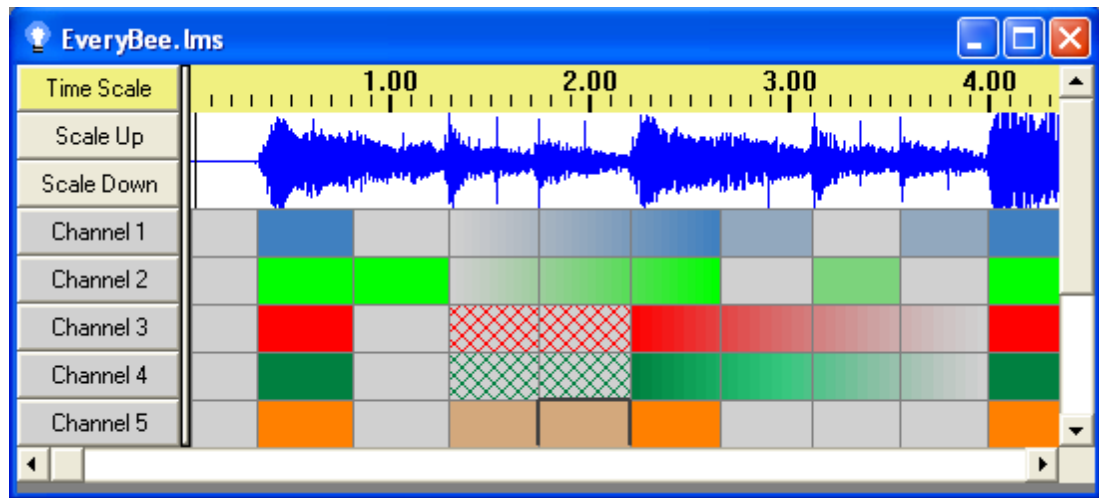

A sequence, with a time scale displayed

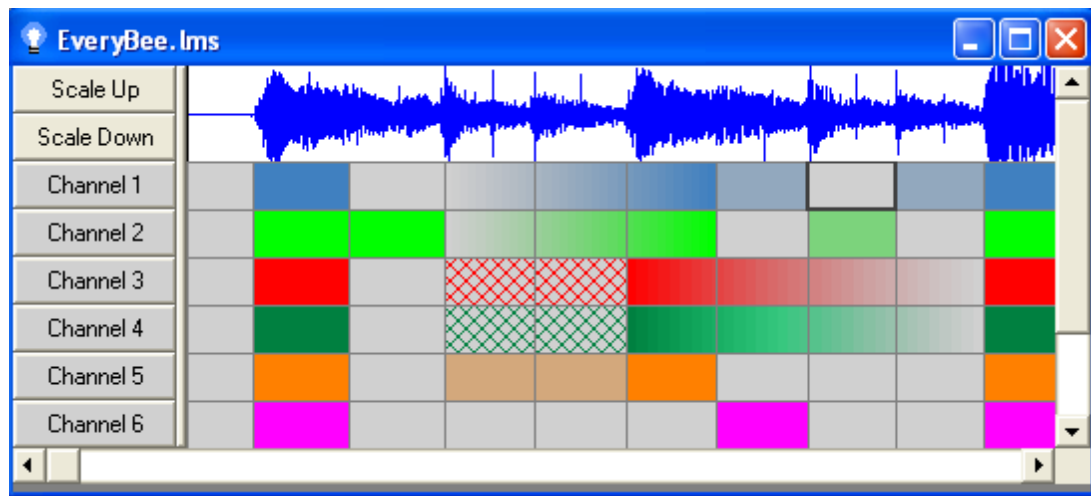

The same sequence, with no time scale displayed

View Wave Form by Default

If this box is checked, then whenever a [musical sequence](#) is created or opened, a [wave form](#) of the song will be displayed near the top of the sequence (except for sequences using certain types of media files, such as MIDI files and video files). This setting has no effect on the display of musical sequences using those types of media files, or of [animation sequences](#).

If you do not want to change this default, but want to temporarily change whether wave form is displayed or not, you can use "[Wave Form](#)" from the [View menu](#), or "[View Wave Form](#)" from the [Standard toolbar](#).

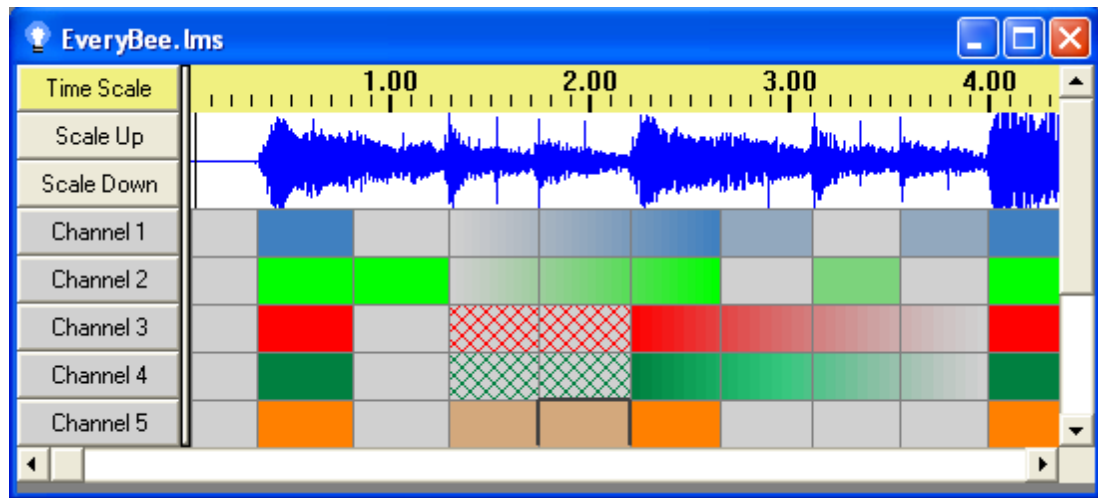

A sequence, with a waveform displayed

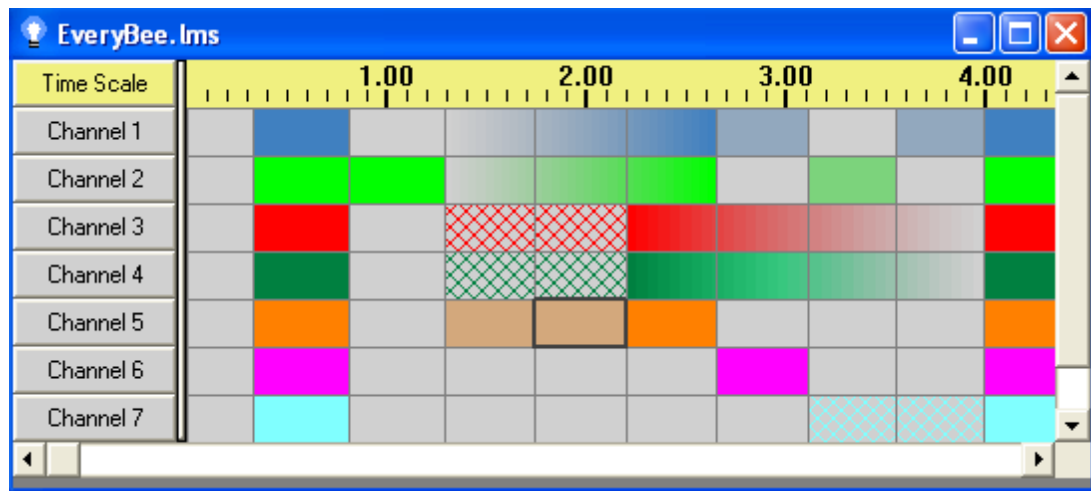

The same sequence, with no waveform displayed

Tooltip Preferences

- [Enable tooltips](#)
- [Seconds before opening](#)
- [Seconds before closing automatically](#)
- [Manually close tooltips on mouseover](#)
- [Manually close tooltips on click](#)

Enable tooltips

If this box is checked, when the mouse is over a [sequence](#) grid, a tooltip displaying information about the cell being pointed to can be displayed. You can control more specific behaviors of the tooltip via [other tooltip preferences](#).

Seconds before opening

If [tooltips are enabled](#), this text box controls how many seconds it will take before the tooltip pops up, when the mouse is kept still over a [sequence](#) grid.

You do not have to specify a whole number; for example, you can set it to three-quarters of a second by entering "0.75".

Use Channel Colors

If [tooltips are enabled](#), this checkbox controls whether or not tooltips associated with [channels](#) will display the color of the channel.

Seconds before closing automatically

If [tooltips are enabled](#), this checkbox and text box control whether or not they will automatically close themselves a certain amount of time after being opened. If the checkbox is checked, they will automatically close after the number of seconds specified in the text box.

You do not have to specify a whole number; for example, you can set it to three-quarters of a second by entering "0.75".

Manually close tooltips on mouseover

If [tooltips are enabled](#), selecting this option will make them close when you roll your mouse over them. The other option is to make them [close when you click on them](#).

Manually close tooltips on click

If [tooltips are enabled](#), selecting this option will make them close when you click on them. The other option is to make them [close when you roll your mouse over them](#).

Animation Redraw Throttling

During play, the [Animator](#) will only redraw the [animation](#) every so often, suppressing more frequent redraw requests. This is done to try to ensure that it does not take up too much of the computer's CPU time. However, it means that very fast [events](#) may not get displayed by the Animator (although they will still affect your actual lights).

The amount of throttling that the Animator will do is configurable. By default, it is set to "Low", which means that it doesn't throttle very much, and therefore the animation should be as smooth as possible. The cost of this smoothness is that the Animator will use more of your computer's CPU time.

So, if you notice that the Animator is having a hard time keeping up with your [sequence](#), making the animation and perhaps even the sequence itself choppy or sluggish, it may be because the Animator is using too much CPU time for your computer. In this case, you may want to try changing this setting to "Medium", which will cause the Animator to allow redrawings less frequently, thereby decreasing the amount of CPU time it uses. "High" will decrease CPU utilization even further.

Advanced OpenGL Settings

This button opens up the [Advanced OpenGL Settings dialog](#), which can be used experimentally to try to resolve various strange graphics issues. However, this is not recommended, and often other steps (such as updating your graphics card's driver) will resolve graphics issues in a better manner.

The Advanced OpenGL Settings dialog (which can be accessed from the [Display Preferences dialog](#)) can be used, experimentally, to try to resolve various strange graphics issues, such as a blank area appearing where the grid of a [sequence](#) should be, or the grid appearing offset from where it should be (e.g. the rows of the grid do not properly line up with the [channel buttons](#)).

However, this is not recommended. Typically, such issues can be better resolved in other ways, such as updating your computer's graphics card's drivers. Some people have also had luck resolving such issues by doing things such as disabling advanced Windows themes (such as "Aero"), by disabling "hardware acceleration" in their graphics card's settings, or by changing their Windows display settings from 32 bit color to 16 bit color.

The Advanced OpenGL Settings dialog can be used as another option to these methods, but, again, it is not suggested. Changing the settings using this dialog could conceivably cause other strange graphics issues, or cause the [Sequence Editor](#) to run slowly.

The dialog allows you to choose between two options: "Use the default Windows pixel format" (which is recommended), and "Use a specific pixel format". If you chose to use a specific pixel format, then you can choose it from the dropdown list immediately below that option.

The list of pixel formats does not include all possible pixel formats that are available on your computer; instead, it only includes those that seem to meet the requirements of the Light-O-Rama Sequence Editor. It also includes brief descriptions of each of them; the meanings of these descriptions are beyond the scope of this help file. If you would like to know what they mean, please consult OpenGL documentation.

In either case, whether you choose to use the default Windows pixel format or a specific pixel format, a preview picture will be displayed at the bottom of the dialog, drawn using that pixel format. If the picture does not look as its description says it should, then the chosen pixel format will probably not work correctly on your computer.

Some pixel formats may be more efficient than others, so even if a pixel format seems to work, it may cause the Sequence Editor to run more slowly than normal. So, if you choose to change the pixel format in use, and the Sequence Editor then seems choppy or slow, you may want to try another pixel format.

After you choose a pixel format and exit the dialog, you may have to close the Sequence Editor and restart it before your changes will fully take effect.

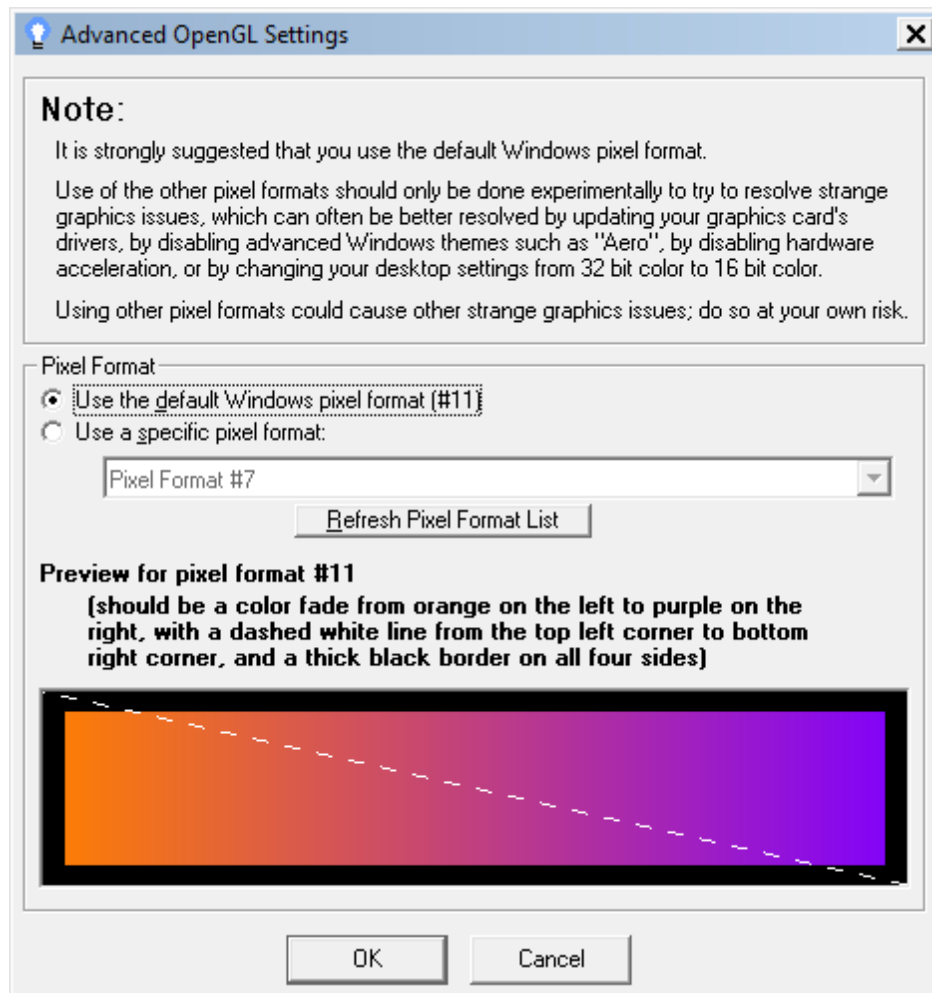

The Advanced OpenGL Settings dialog

5.3.4.2.2.3 DMX Preferences

By default, the [DMX intensity](#) tool is not available for use in the [Sequence Editor](#). This means that no toolbar icon will be shown for it on the [Tools toolbar](#), nor a menu item in the [Tools menu](#), nor will a [keyboard shortcut](#) be available for it. To enable these things, turn on "Allow DMX Editing" in the DMX Preferences submenu of the [Preferences menu](#) of the [Edit menu](#):

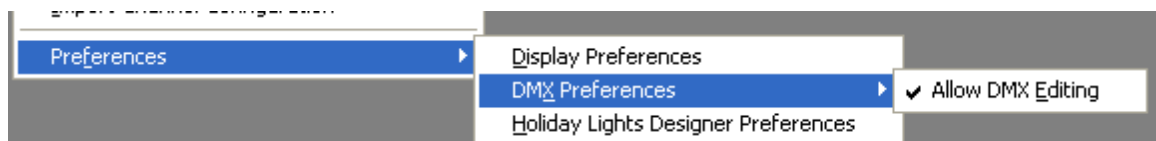

The DMX Preference menu

Note: DMX communication settings are controlled through the [Network Preferences dialog](#), not through DMX Preferences.

5.3.4.2.2.4 Holiday Lights Designer Preferences

[Holiday Lights Designer](#)[™] is a third-party application, by [Holidaysoft](#)[®], that can be used to virtually place lights and decorations on images of your home or business. Light-O-Rama can send Holiday

Lights Designer™ commands during play to make those virtual lights behave as your real lights would during a [show](#). The Holiday Lights Designer™ Preferences dialog (in the [Preferences submenu](#) of the [Sequence Editor's Edit menu](#)) is used to set up how Light-O-Rama interacts with Holiday Lights Designer™.

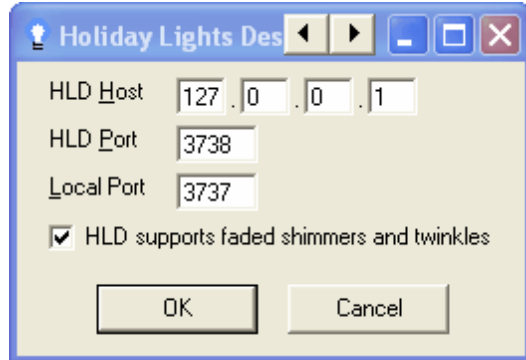

The Holiday Lights Designer Preferences dialog

To use this dialog, enter the IP address and port that Holiday Lights Designer™ listens to in the "HLD Host" and "HLD Port" fields, and the port that Light-O-Rama should listen to in the "Local Port" field. If Holiday Lights Designer™ is running on the same machine as Light-O-Rama, setting the HLD Host to 127.0.0.1 will likely work.

Similar settings may need to be made in the configuration of Holiday Lights Designer™ itself.

Some older versions of Holiday Lights Designer™ support [shimmers](#) and [twinkles](#) only as full intensity shimmers and twinkles; [custom shimmers and twinkles](#) (such as faded shimmers) are not supported. If your [sequence](#) contains such an effect, and it is sent to a version of Holiday Lights Designer™ without support for it, Holiday Lights Designer™ will simply ignore the effect. However, you could uncheck the "HLD supports faded shimmers and twinkles" box; this causes Light-O-Rama to send Holiday Lights Designer™ all shimmers and twinkles as if they were full intensity shimmers and twinkles, allowing these older versions of Holiday Lights Designer™ to at least partially display these effects. Note that this does not affect the behavior of your actual lights; it only affects what is displayed in Holiday Lights Designer™.

Additionally, commands will only be sent from Light-O-Rama to Holiday Lights Designer™ if "[Control Holiday Lights Designer](#)" is turned on in the [Sequence Editor's Play menu](#), or if "[Holiday Lights Designer On](#)" is enabled in the [Light-O-Rama Control Panel](#).

All of these settings will be used not only when [sequences](#) are played using the Sequence Editor, but also when [shows](#) are played using the [Show Player](#).

5.3.4.2.2.5 Keyboard Preferences

In the [Sequence Editor](#), you can [use the keyboard to make changes](#) to a [sequence](#); there are several built-in functions that can be performed by striking certain keys. For example, you can turn the currently selected cell (or cells) [on](#) by hitting the "N" key. However, you can also change these behaviors - change what keys perform what functions. You can even make a single key perform multiple functions - for example, you could set up the "N" key to expand the selection to the right by three cells and down by two cells, and then turn the entire (newly expanded) selection on.

To control the behaviors of the keys, select Keyboard Preferences from the [Preferences submenu](#) of the [Edit menu](#). Doing so will open the Keyboard Preferences dialog:

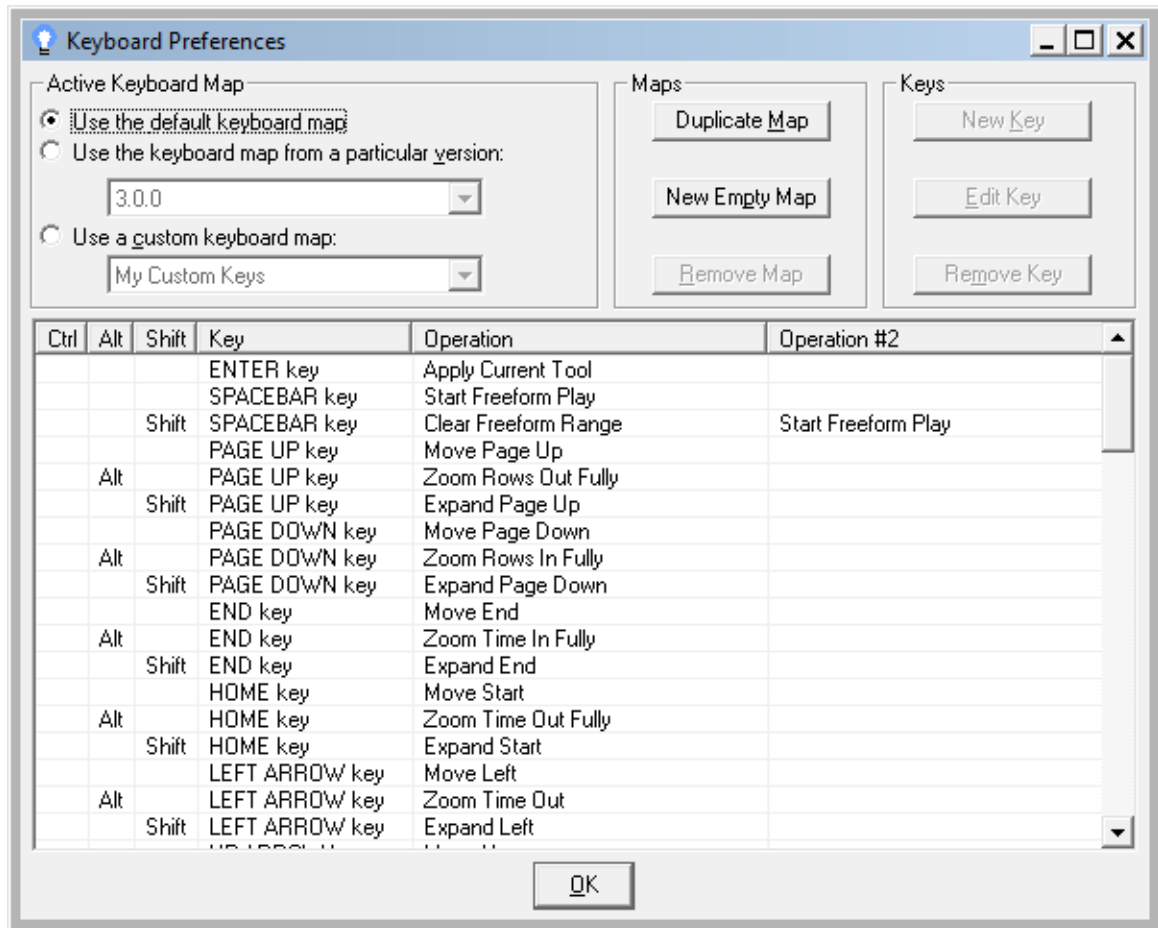

The Keyboard Preferences dialog

The Keyboard Preferences dialog has four sections:

- The "[Active Keyboard Map](#)" section allows you to choose what set of keyboard operations should be used;
- The "[Maps](#)" section allows you to define new sets of keyboard operations, or to delete existing sets;
- The "[Keys](#)" section allows you to define what keys should perform what operations in the currently active set of keyboard operations;
- The bottom section displays all keys in the current set of keyboard operations, and the [operations](#) that they perform.

Active Keyboard Map

The "Active Keyboard Map" section allows you to choose which keyboard map should currently be used. You can choose to [use the default keyboard map for the current version of software](#), to [use the default keyboard map from a specific \(perhaps earlier\) version of software](#), or to [use a custom keyboard map that you have defined](#).

Use the Default Keyboard Map

Choosing this option will cause the [Sequence Editor](#) to use its default keyboard map. Moreover, if you have this option selected, and later upgrade to a new version of software which has a different default keyboard map, the Sequence Editor will then use that new default keyboard map.

Use the Keyboard Map from a Particular Version

Choosing this option will cause the [Sequence Editor](#) to use the default keyboard map from some specific version of the software. Moreover, if you have this option selected, and later upgrade to a new version of software which has a different default keyboard map, the Sequence Editor will then continue to use the default map from the specific version that you have selected.

Use a Custom Keyboard Map

Choosing this option will cause the [Sequence Editor](#) to use a keyboard map that you yourself have defined. Moreover, if you have this option selected, and later upgrade to a new version of software which has a different default keyboard map, the Sequence Editor will then continue to use the custom map that you have selected.

Your custom keyboard maps are automatically saved to your "KeyMaps" directory (in your Light-O-Rama data directory). If you would like to share one of your custom maps with another user, you can simply give them a copy of that map's file. When they place it into their own "KeyMaps" directory, it will be available for them as a custom keyboard map.

Note that this option is not available until you have defined at least one custom keyboard map, which you can do through either "[Duplicate Map](#)" or "[New Empty Map](#)".

Maps

The "Maps" section allows you to create new custom keyboard maps (either [duplicating the current map](#) or else [creating an empty map](#)), or to [remove maps that you have previously created](#).

Duplicate Map

Using this button, you can create a new custom keyboard map which uses the exact same key mappings as the currently selected map does. You can then modify the key mappings as you desire, using "[New Key](#)", "[Edit Key](#)", or "[Remove Key](#)".

The new map will show up in the dropdown list under "[Use a Custom Keyboard Map](#)", and in fact will automatically be selected when you create it.

New Empty Map

Using this button, you can create a new custom keyboard map which does not contain any key mappings at all - that is, no key will cause anything to happen when you press it. You can then add keys to it via "[New Key](#)", and later edit or remove them via "[Edit Key](#)" or "[Remove Key](#)".

The new map will show up in the dropdown list under "[Use a Custom Keyboard Map](#)", and in fact will automatically be selected when you create it.

Remove Map

If you have currently selected a custom keyboard map (via "[Use a Custom Keyboard Map](#)"),

pressing this key will delete the map.

Note that if there is a chance that you will want to use the custom keyboard map again in the future, you should not remove it. Instead, simply switch to using a different custom map, or to a default map, leaving the map in the "Use a Custom Keyboard Map" list, thus enabling you to switch back to it when you desire. If you remove it, you will not be able to switch back to it in the future.

Keys

If you have specified that a custom keyboard map should be used (via "[Use a Custom Keyboard Map](#)"), then the "Keys" section allows you to [add new keys to it](#), [edit existing keys within it](#), and [remove existing keys from it](#).

New Key

This button (which is available only when a custom keyboard map has been selected, via "[Use a Custom Keyboard Map](#)") opens up the New Key Mapping dialog, which allows you to choose a key and set its [operation](#) or operations:

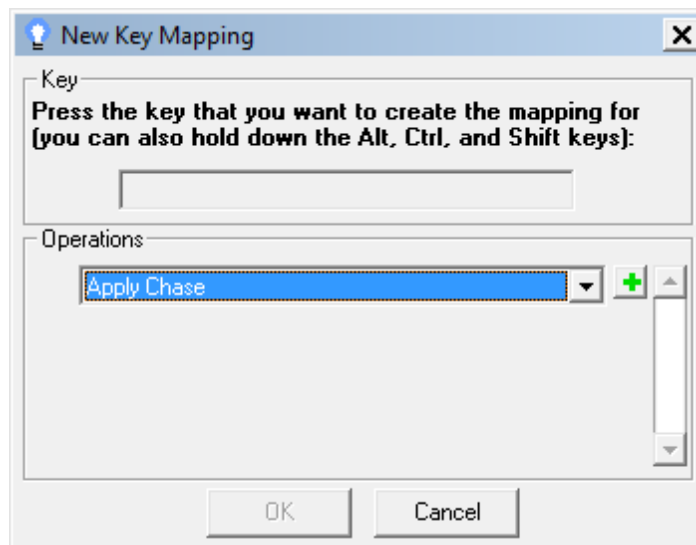

The New Key Mapping dialog

To use the New Key Mapping dialog, press the key that you want to use (and, if you want, the Alt, Ctrl, and/or Shift keys), and then select the operation that you want it to perform from the dropdown list:

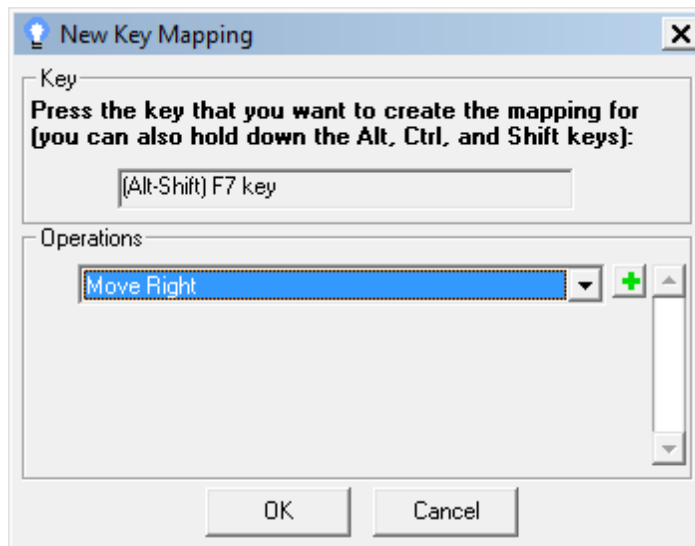

The New Key Mapping dialog, having selected a key and an operation

In the above example, Alt-Shift-F7 has been mapped to "Move Right" - that is, to move the selection to the right one cell.

You can use the green "+" button to assign multiple operations to a single key. They will be executed in the order that you list them. In the following example, Alt-Shift-F7 has been mapped to "Move Right, Move Down, Apply Shimmer". That is, the selection will be moved one square to the right, then one square down, and then the [Shimmer tool](#) will be applied to the new selection.

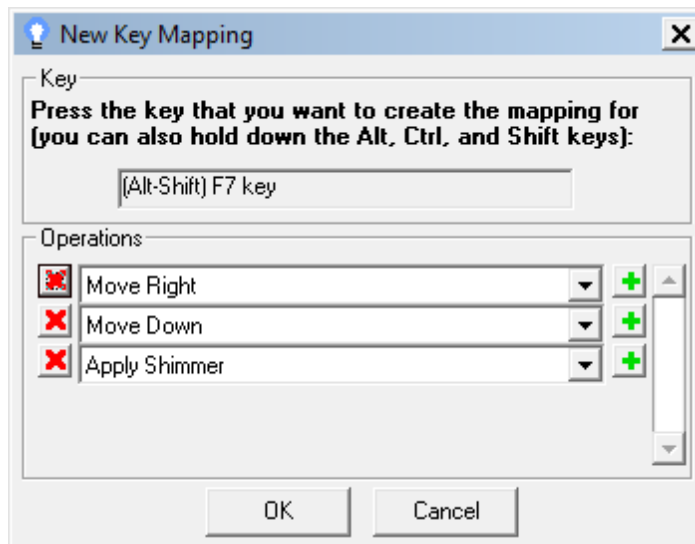

The New Key Mapping dialog, having selected a key and multiple operations

When multiple operations have been selected, you can delete any of them via the red "X" button next to it.

Edit Key

This button allows you to change the [operation](#) or operations that are in use for a certain key. It is available only when a custom keyboard map has been selected (via "[Use a Custom Keyboard Map](#)")

and a particular key mapping from that map has been selected (by clicking on it in the list of key mappings at the bottom of the [Keyboard Preferences dialog](#)).

Pressing the button brings up the Edit Key Mapping dialog:

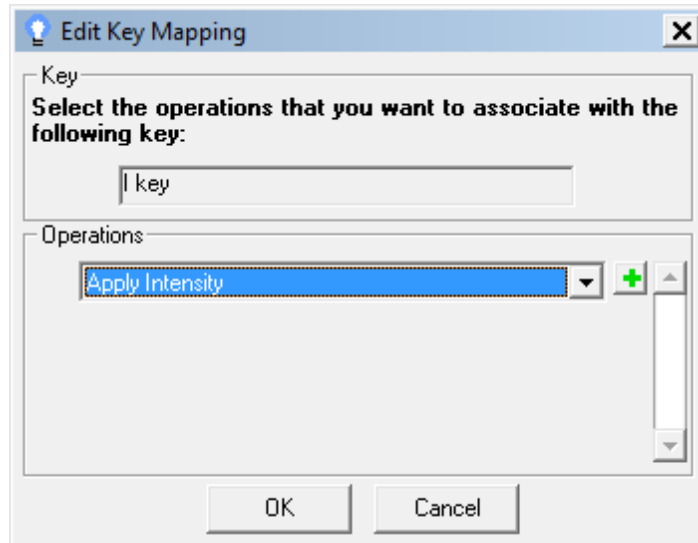

The Edit Key Mapping dialog

The Edit Key Mapping dialog can be used similarly to the [New Key Mapping dialog](#), except that only the operations can be changed (or added to or removed from), not the key itself.

Remove Key

This button allows you to remove a certain key from the current keyboard map. It is available only when a custom keyboard map has been selected (via "[Use a Custom Keyboard Map](#)") and a particular key mapping from that map has been selected (by clicking on it in the list of key mappings at the bottom of the [Keyboard Preferences dialog](#)).

Operations

The following operations can be assigned to keys (in a [custom keyboard map](#)):

Operation	Description
Apply Chase	Apply the Chase tool to the current selection
Apply Color Fade	Apply the Color Fade tool to the current selection
Apply Current Tool	Apply the current tool to the current selection
Apply DMX Intensity	Apply the DMX Intensity tool to the current selection
Apply Fade Down	Apply the Fade Down tool to the current selection
Apply Fade Up	Apply the Fade Up tool to the current selection
Apply Fill	Apply the Fill tool to the current selection
Apply Intelligent Fade	Apply the Intelligent Fade tool to the current selection
Apply Intensity	Apply the Set Intensity tool to the current selection
Apply Off	Apply the Off tool to the current selection

Apply On	Apply the On tool to the current selection
Apply Paint Sequence	Apply the Paint Sequence tool to the current selection
Apply Shimmer	Apply the Shimmer tool to the current selection
Apply Toggle	Apply the Toggle tool to the current selection
Apply Twinkle	Apply the Twinkle tool to the current selection
Change Custom: Fade Down	Change the current custom tool to be a fade down tool
Change Custom: Fade Up	Change the current custom tool to be a fade up tool
Change Custom: Intensity	Change the current custom tool to be a set intensity tool
Change Custom: Shimmer	Change the current custom tool to be a shimmer tool
Change Custom: Twinkle	Change the current custom tool to be a twinkle tool
Change Effects: Regular	Disable Foreground Effects and Background Effects
Change Effects: Toggle Background	Enable Background Effects if it is currently disabled, or disable it if enabled
Change Effects: Toggle Foreground	Enable Foreground Effects if it is currently disabled, or enable it if disabled
Clear Freeform Range	Clear the freeform play range (if one exists)
Copy	Copy the effects from the current selection
Copy Timing	Copy the timings from the current selection
Cut	Cut the effects from the current selection
Expand Down	Expand the current selection down one channel
Expand End	Expand the current selection to the end of the track's time if it is not already; if it is already, expand it to the end of the track's channels also
Expand Left	Expand the current selection left one cell
Expand Page Down	Expand the current selection down one screen
Expand Page Up	Expand the current selection up one screen
Expand Right	Expand the current selection right one cell
Expand Start	Expand the current selection to the start of the track's time if it is not already; if it is already, expand it to the start of the track's channels also
Expand Up	Expand the current selection up one channel
Help	Open the help file
Move Down	Move the current selection down one channel
Move End	Move the current selection to the end of the track's time if it is not already; if it is already, move it to the end of the track's channels also
Move Left	Move the current selection left one cell
Move Page Down	Move the current selection down one screen
Move Page Up	Move the current selection up one screen
Move Right	Move the current selection right one cell
Move Start	Move the current selection to the start of the track's time if it is not already; if it is already; move it to the start of the track's channels also
Move Up	Move the current selection up one channel
New Sequence	Create a new sequence
Next Keystroke: Background Effects	Apply Background Effects to the next effect tools

	keystroke (or the next effect tools operation of this keystroke)
Next Keystroke: Foreground Effects	Apply Foreground Effects to the next effect tools keystroke (or to the next effect tools operation of this keystroke)
Next Keystroke: Regular Effects	Apply Regular Effects to the next effect tools keystroke (or to the next effect tools operation of this keystroke)
Open Existing Sequence	Open an existing sequence
Open Recent Sequence	Open a recent sequence
Paste	Paste from the current clipboard to the current selection
Paste Timing	Paste timings to the current selection
Redo	Redo the last operation that was undone
Refresh	Refresh the display
Repeat	Apply the Repeat tool to the current selection
Save Sequence	Save the current sequence
Select Chase	Make the Chase tool be the current tool
Select Color Fade	Make the Color Fade tool be the current tool
Select Custom Tool	Make the current custom tool be the current tool
Select DMX Intensity	Make the DMX Intensity tool be the current tool
Select Fade Down	Make the Fade Down tool be the current tool
Select Fade Up	Make the Fade Up tool be the current tool
Select Fill	Make the Fill tool be the current tool
Select Intelligent Fade	Make the Intelligent Fade tool be the current tool
Select Intensity	Make the Set Intensity tool be the current tool
Select Off	Make the Off tool be the current tool
Select On	Make the On tool be the current tool
Select Paint Sequence	Make the Paint Sequence tool be the current tool
Select Select	Make the Select tool be the current tool
Select Shimmer	Make the Shimmer tool be the current tool
Select Toggle	Make the Toggle tool be the current tool
Select Twinkle	Make the Twinkle tool be the current tool
Start Freeform Play	Start play using the freeform play range
Tooltip	Open up a tooltip appropriate to where the mouse cursor is currently pointing on the sequence grid
Undo	Undo the last operation
Zoom Rows In	Zoom in on rows (channels)
Zoom Rows In Fully	Zoom in on rows (channels) as far as possible
Zoom Rows Out	Zoom out on rows (channels)
Zoom Rows Out Fully	Zoom out on rows (channels) as far as possible
Zoom Time In	Zoom in on time (columns)
Zoom Time In Fully	Zoom in on time (columns) as far as possible
Zoom Time Out	Zoom out on time (columns)
Zoom Time Out Fully	Zoom out on time (columns) as far as possible

5.3.4.2.2.6 Visualizer Preferences

The Visualizer Preferences dialog (in the [Preferences submenu](#) of the [Sequence Editor's Edit menu](#)) allows you to set up the host address and port that will be used to send lighting commands to the [Light-O-Rama Visualizer](#).

Please also see the [Play Menu's "Control Visualizer"](#) menu item.

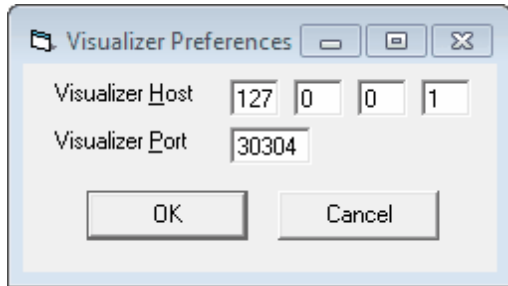

The Visualizer Preferences dialog

5.3.4.2.2.7 Network Preferences

[Light-O-Rama software](#) running on a computer can control several types of [hardware controllers](#). To do so, most of these types must be hooked up to the computer using a serial port (adapters such as the USB-RS485 are available from Light-O-Rama if your computer does not have a serial port). The [Sequence Editor's](#) Network Preferences dialog, available from the [Preferences submenu](#) of the [Edit menu](#), can be used to configure the serial ports on your computer to support different types of hardware controllers.

[Light-O-Rama controllers](#) can be controlled on up to sixteen different networks, each using a different serial port (referred to as the "regular network" and three auxiliary networks, "Aux A", "Aux B", "Aux C", and so on, up to "Aux O").

If you have any [Dasher controllers](#), they must be on their own serial port (referred to as the "Dasher port"). Similarly, [X10 controllers](#) must be on their own serial port as well (the "X10 port").

[Native DMX devices](#) can be controlled on up to sixteen different universes, each using a different DMX adapter (such as an ENTTEC Open DMX USB adapter).

Light-O-Rama can control hardware on all of these ports (as well as on [Digital IO cards](#) and [BSOFT Digital IO cards](#), which do not use serial ports) simultaneously.

For details on how to use the Network Preferences dialog, please refer to the following individual sections:

- [Light-O-Rama Networks](#)
 - [The Serial Ports](#)
 - [Connection Speed](#)
 - [List Networks in Channel Configuration](#)
 - [Compatibility](#)
- [DMX Universes](#)
 - [Adapter](#)
 - [Protocol](#)
 - [DMX Listener Port](#)
- [Dasher Port](#)
- [X10 Port](#)

NOTE: Most users will only have the "Regular Light-O-Rama Network".

Light-O-Rama Networks

Network	Port	Speed	Network	Port	Speed
Regular	Comm 7	Average (Recommended)	Aux H	(None)	Average (Recommended)
Aux A	(None)	Average (Recommended)	Aux I	(None)	Average (Recommended)
Aux B	(None)	Average (Recommended)	Aux J	(None)	Average (Recommended)
Aux C	(None)	Average (Recommended)	Aux K	(None)	Average (Recommended)
Aux D	(None)	Average (Recommended)	Aux L	(None)	Average (Recommended)
Aux E	(None)	Average (Recommended)	Aux M	(None)	Average (Recommended)
Aux F	(None)	Average (Recommended)	Aux N	(None)	Average (Recommended)
Aux G	(None)	Average (Recommended)	Aux O	(None)	Average (Recommended)

DMX Universes

Universe	Adapter	Protocol	Universe	Adapter	Protocol
1	A8008fa6	Raw DMX	9	(None)	Raw DMX
2	A5006ITZ	Raw DMX	10	(None)	Raw DMX
3	(None)	Raw DMX	11	(None)	Raw DMX
4	(None)	Raw DMX	12	(None)	Raw DMX
5	(None)	Raw DMX	13	(None)	Raw DMX
6	(None)	Raw DMX	14	(None)	Raw DMX
7	(None)	Raw DMX	15	(None)	Raw DMX
8	(None)	Raw DMX	16	(None)	Raw DMX

DMX Listener Port: 8837

Additional Networks

X10 Comm 5 Dasher Port (None)

Advanced Settings

List networks in channel configuration

Use compatibility mode for old MC-P channel controllers

OK Cancel

The Network Preferences Dialog

Light-O-Rama Networks

Up to sixteen different networks for [Light-O-Rama controllers](#) can be specified here, each with a different [serial port](#). The [communications speed](#) of each can be set independently. If you only want to use a single Light-O-Rama network (which is perfectly sufficient for many users' needs), you can choose to simplify the behavior of the [Sequence Editor](#) in various ways by turning off "[List networks in channel configuration](#)". Finally, if you own certain old Light-O-Rama controllers, you should use the "[Compatibility](#)" section to let Light-O-Rama know so that it can support them correctly.

The Serial Ports

In the dropdown box for each [Light-O-Rama network](#), choose the serial port that you wish to use for that network. Make sure that they do not conflict with each other, or with the [Dasher port](#) or the [X10](#)

[port](#).

If you don't want to use all sixteen possible networks, you can simply set some of them to "(None)". Using only a single Light-O-Rama network is perfectly sufficient for the needs of many users.

Connection Speed

Light-O-Rama can communicate with [Light-O-Rama controllers](#) using various communication speeds. These speeds can be set independently for each [Light-O-Rama network](#).

If you do not have extraordinary needs, "Average (Recommended)" is suggested.

If your controllers are hooked to your computer using a very long or poor quality communications cable, you may need to set the speed to "Long Range (Slower)".

If you have many circuits with very fast action you may need to set the speed to "Short Range (Faster)". This setting is not supported if you are using Light-O-Rama Easy Light Linkers for wireless communications.

List Networks in Channel Configuration

Although Light-O-Rama supports up to sixteen separate [networks](#) of [Light-O-Rama controllers](#), the needs of many users will be met adequately with a single network. If this is the case for you, you may wish to turn off this checkbox. Doing so will simplify using the [Sequence Editor](#) a little, by disabling the dropdown boxes which let you assign a network to a [channel](#) (for example, on the [Channel Configuration screen](#) or the [Channel Settings dialog](#)). Instead, the "Regular" network will automatically be used.

Compatibility

If you are using Light-O-Rama MC-P [controllers](#) purchased prior to November 15, 2003, then you should enable Old MC-P Compatibility mode by checking its compatibility box. If you do not check this box, then you will see odd behavior on circuits 9 through 16 of such controllers.

Old MC-P Compatibility mode only affects controllers on the regular LOR [network](#). Controllers on auxiliary networks are unaffected.

Enabling Old MC-P Compatibility mode may have a significant effect on communications speed for the regular network. For this reason, it is strongly recommended that you do not enable it without reason. Also, if you do enable it, consider moving any other controllers (which do not need Old MC-P Compatibility mode) off of the regular network, and onto one or more auxiliary networks.

DMX Universes

For a [channel](#) to control a [DMX device](#), the device must be assigned to a universe (which can be done, for example, through the [Sequence Editor's Channel Configuration Screen](#)). That universe is a number between 1 and 16. The [Network Preferences dialog](#) can then be used to assign a DMX [adapter](#) (such as an ENTTEC Open DMX USB) to that universe, as well as to specify the particular type of DMX [protocol](#) that the adapter uses.

The Network Preferences dialog can also be used to set the [DMX listener port](#), which is the TCP/IP port that the [LOR Comm Listener](#) will listen on for DMX commands.

DMX Adapter

Each DMX universe to be used must be assigned a DMX adapter, such as an ENTTEC Open DMX USB adapter. Each adapter can only be assigned to one universe.

For each universe, the [Network Preferences dialog](#) presents a dropdown list of DMX adapters available on the system. Note that the Network Preferences dialog cannot detect adapters that are currently in use, and so if (for example) you have an LOR USB485 adapter that is currently assigned to an [LOR network](#), which you want to instead assign to a DMX universe, you may have to first unassign it from the LOR network and then stop/start the [Sequence Editor](#) (and possibly the [Hardware Utility](#) and the [Show Player](#)) before it will appear in the Network Preferences dialog's list of DMX adapters.

Also note that there are different types of [DMX protocol](#); the type to use depends upon the type of adapter, and can also be specified via the Network Preferences dialog.

DMX Protocol

There are different flavors of DMX protocol; for each [DMX adapter](#) that you use, you must use the [Network Preferences dialog](#) to specify the appropriate DMX protocol to use for that adapter. The protocol depends upon the type of DMX adapter:

Adapter Type	Protocol
ENTTEC DMX USB Pro	ENTTEC DMX USB Pro
ENTTEC Open DMX USB	Raw DMX
LOR USB485	Raw DMX
LOR USB485B	Raw DMX
Lynx	Lynx

It is possible that other types of USB DMX adapters may work, but they may not, and if they do you may have to experiment to find the appropriate protocol to use.

DMX Listener Port

The [Network Preferences dialog](#) can be used to specify the DMX listener port, which is the TCP/IP port that the [LOR Comm Listener](#) will listen on for commands to be sent to [DMX devices](#).

Setting the DMX listener port to 0 will disable the listener.

Dasher Port

If you are using any [Dasher controllers](#), they must be hooked to your computer on their own serial port. Set the serial port used for Dasher controllers here. Make sure that it does not conflict with any of the ports used for [Light-O-Rama networks](#), or with the [X10 port](#).

If you are not going to use any Dasher controllers, simply set the Dasher port to "(None)".

X10 Port

If you are using any [X10 controllers](#), they must be hooked up to your computer on their own serial

port. Set the serial port used for X10 controllers here. Make sure that it does not conflict with any of the ports used for [Light-O-Rama networks](#), or with the [Dasher port](#).

If you are not going to use any X10 controllers, simply set the X10 port to "(None)".

5.3.4.2.2.8 New Animation Preferences

The [Sequence Editor's New Animation dialog](#) is used to create new [animation sequences](#). When a new animation sequence is created, it allows you to specify things like the name of the author of the sequence and how many channels the sequence will use.

You can change the default answers to most of these questions, so that you don't have to type them in every time, by selecting "New Animation Preferences" from the [Preferences submenu](#) of the [Edit menu](#).

For more detailed help, please refer to the help page for the [New Animation dialog](#).

The screenshot shows the "New Animation Options" dialog box. It features a title bar with a lightbulb icon and a close button. The dialog is organized into several sections. The first section asks "Who is the author of this new animation?" with an empty text input field. The second section asks "How many channels should this animation use?" with a text input field containing the number "8". Below this is a checked checkbox labeled "Automatically set up channels to use standard LDR controllers". The third section asks "How long should this animation be?" with a text input field containing "1:00.00". The fourth section asks "How much time should be in between timings?" and includes five radio button options: "A tenth of a second" (which is selected), "Half a second", "A second", "Some other value:" (with a text input field containing "0.10"), and "Don't add any timings". Below these is a checked checkbox "Use a fixed timing grid". The fifth section contains a checked checkbox "Use loops.". The final section has two unchecked checkboxes: "Save these choices as defaults." and "Don't ask me this again.". At the bottom of the dialog are "OK" and "Cancel" buttons.

The New Animation dialog

5.3.4.2.2.9 New Musical Sequence Preferences

The [Sequence Editor's New Musical Sequence dialog](#) is used to create new [musical sequences](#). When a new musical sequence is created, it allows you to specify things like the name of the author of the sequence and how many channels the sequence will use.

You can change the default answers to most of these questions, so that you don't have to type them in every time, by selecting "New Musical Sequence Preferences" from the [Preferences submenu](#) of the [Edit menu](#).

For more detailed help, please refer to the help page for the [New Musical Sequences dialog](#).

New Musical Sequence Options

Author of this new sequence (optional)

01 - Jackie.mp3

Artist

Title

Album

Channel Setup

Select channel count -- can be changed later Number of channels used Using standard LOR controllers

Use a saved channel configuration template

Initial Timing

Use a Wizard to create timings -- Wizards can be used later --

- Use the MIDI Wizard
- Use the Tapper Wizard
- Use the Beat Wizard
- Use the VU Wizard
- Don't add any timings**

Use equally spaced timings Fixed grids must be set now

- A tenth of a second
- Half a second**
- A second
- Some other value:

Use a fixed timing grid

Save as defaults.

Don't ask me this again.

5.3.4.2.2.10 Play Preferences

The [Sequence Editor](#) can be used not only to create and edit [sequences](#), but also to test them by playing them. The Play Preferences dialog of the [Preferences submenu](#) of the [Edit menu](#) allows control over certain aspects of how it plays them.

Note: These settings *only* affect play in the Sequence Editor. They do not affect play of [Shows](#), via the [Show Player](#).

The following options can be set in the Play Preferences dialog:

- [Vary the Color of Channel Buttons during Play by Default](#)
- [Also Vary Their Font Colors](#)

- [Loop at the End of a Sequence by Default](#)
- [Highlight Current Event during Play by Default](#)
- [Highlight Current Time during Play by Default](#)
- [Use Play Range for Wizards](#)



Vary the Color of Channel Buttons during Play by Default

[Channels](#) can be assigned colors. When a [lighting effect](#) is shown by the [Sequence Editor](#) in a [sequence's](#) grid, that color (or one based on it) will be used. This doesn't affect your actual lights, but it might be helpful to set the channels in your sequence to have the same colors as the real lights that will be hooked up to them.

When the Sequence Editor plays a sequence, it can vary the colors of the [channel buttons](#) to show the lighting effect taking place on that channel at that instant. For example, during a [fade up](#), the color of the channel button will gradually fade from the default light grey up to the color assigned to that channel.

If you prefer not to see the channel buttons' colors vary this way during play, you can uncheck "Vary the color of channel buttons during play by default", and the channel buttons will simply remain light grey during play, regardless of what lighting effects occur.

If you do not want to change this preference as a default, but do want to temporarily change it, you can do so via "[Vary Color of Channel Buttons](#)" on the [Play menu](#), or by the "[View Channel Button Colors](#)" button on the [Standard toolbar](#).

See also "[Also Vary Their Font Colors](#)".

Also Vary Their Font Colors

If you have [channel buttons](#) set up to change color during play, the color of the text on them can also change during play, to try to keep a high contrast between the button color and the text color, so as to keep the text readable. However, some users have found the changing font colors to be distracting. So, the "Also vary their font colors" option in the [Play Preferences dialog](#) allows you to control whether or not the font colors will be changed during play, by default.

If you do not want to change this preference as a default, but do want to temporarily change it, you

can do so via "[Vary Color of Channel Button Fonts](#)" on the [Play menu](#).

See also "[Vary the Color of Channel Buttons during Play by Default](#)".

Loop at the End of a Sequence by Default

Normally, when the [Sequence Editor](#) plays a [sequence](#), play stops automatically when the end of the sequence is reached (or the end of the selection, or of the currently visible screen; please see "[Play Range](#)" on the Play menu for details). However, if "[Loop at End](#)" is selected from the [Play menu](#), then play will instead automatically loop back to the beginning of the play range whenever the end of the play range is reached. To stop playing a sequence when it is looping like this, you must manually stop it, for example via the [Stop button](#) on the [Standard toolbar](#).

On the [Play Preferences menu](#), you can set whether or not "Play at End" is enabled by default whenever the Sequence Editor starts up by choosing a value for "Loop at the end of a sequence by default".

Note that this does not affect the play of your sequences during a [show](#) (via the [Show Player](#)), nor should it be confused with [loops](#) within a sequence.

Highlight Current Event during Play by Default

If the "[Highlight Current Event](#)" option on the [Play menu](#) is enabled, then when the [Sequence Editor](#) plays a [sequence](#), it will highlight the [timings](#) that are closest to the current time with thick black lines, moving them across the sequence's grid as play progresses. For example, if a sequence has timings every half a second, and the current time is 37 and 37/100 seconds, then a thick black border will be made on the timings at 37 seconds and at 37.5 seconds.

On the [Play Preferences menu](#), you can set whether or not "Highlight Current Event" is enabled by default whenever the Sequence Editor starts up by choosing a value for "Highlight current event during play by default".

Highlight Current Time during Play by Default

If the "[Highlight Current Time](#)" option on the [Play menu](#) is enabled, then when the [Sequence Editor](#) plays a [sequence](#), it will draw a dashed vertical line at the current time, which will move across the sequence's grid as play progresses.

On the [Play Preferences menu](#), you can set whether or not "Highlight Current Time" is enabled by default whenever the Sequence Editor starts up by choosing a value for "Highlight current time during play by default".

Use Play Range for Wizards

The [Beat Wizard](#), [Tapper Wizard](#) and [VU Wizard](#) can each be used on an entire song or on only a portion of a song. You can choose which is done from within the wizards themselves, but the "Use Play Range for Wizards" option on the [Play Preferences dialog](#) allows you to set which will be done by default.

If this option is enabled, then when one of these wizards is opened, it will be set to use the [freeform play range](#) (if there is one), or the [play range](#) from the [Play menu](#) otherwise. If this option is

disabled, the wizard will be set to use the entire song.

One exception is when one of these wizards is opened directly from the [New Musical Sequence dialog](#). In this case, the wizard will always default to using the entire song, regardless of how this option is set.

5.3.4.2.2.11 Video Preferences

[Musical sequences](#) are associated with a song or other sound effect, from either an audio file (such as an MP3) or a video file (such as a WMV file). If a musical sequence is associated with a video file, Light-O-Rama can display the video during play. Or, for an audio file, Light-O-Rama can display a visualization.

The Video Preferences dialog, of the [Preferences submenu](#) of the [Sequence Editor's Edit menu](#), can be used to control whether and how video is displayed during play.

Note: These settings affect not only play of [sequences](#) in the Sequence Editor, but also play of [shows](#) by the [Show Player](#).

The following options can be set via the Video Preferences dialog:

- [Display Videos](#)
- [Display Audio Visualizations](#)
- [Use Full Screen Mode](#)
- [Select Monitor](#)

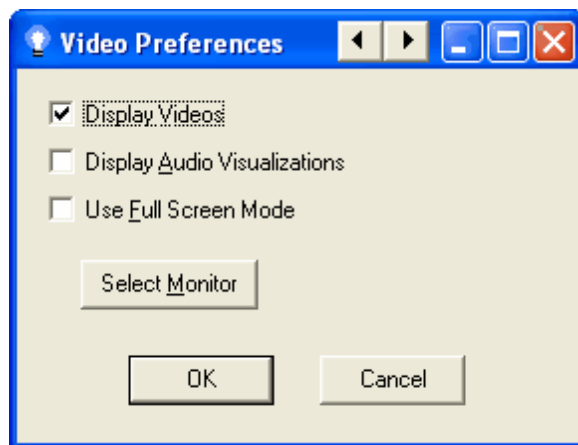

The Video Preferences dialog

Display Videos

If "[Show Videos](#)" is enabled on the [Video submenu](#) of the [View menu](#), and a [musical sequence](#) based on a video file is played by the [Sequence Editor](#), Light-O-Rama will display the video during play.

You can control whether "Show Videos" is enabled by default via this setting on the [Video Preferences menu](#). This also affects play during [shows](#), by the [Show Player](#).

Display Audio Visualizations

If "[Show Audio Visualizations](#)" is enabled on the [Video submenu](#) of the [View menu](#), and a [musical sequence](#) based on an audio file is played by the [Sequence Editor](#), Light-O-Rama will display a visualization of the audio during play.

You can control whether "Show Audio Visualizations" is enabled by default via this setting on the [Video Preferences menu](#). This also affects play during [shows](#), by the [Show Player](#).

Use Full Screen Mode

If "[Full Screen](#)" is enabled on the [Video submenu](#) of the [View menu](#), and a video or audio visualization is displayed for a [musical sequence](#) being played by the [Sequence Editor](#), Light-O-Rama will display the video or visualization during play.

You can control whether "Full Screen" is enabled by default via this setting on the [Video Preferences menu](#). This also affects play during [shows](#), by the [Show Player](#).

Select Monitor

If you have more than one monitor hooked up to your computer, you can use this button to select which monitor Light-O-Rama will use when it displays videos or audio visualizations. This also affects play during [shows](#), by the [Show Player](#).

5.3.4.2.2.12 Zoom Preferences

When a [sequence](#) is displayed in the [Sequence Editor](#), it is represented as a grid. Columns represent time, and rows represent [channels](#). You can zoom the display of either or both of these dimensions in or out for any particular sequence, in a variety of ways (such as by [using the keyboard](#), or various buttons on the [Standard toolbar](#)).

Whenever you set the zoom level for a particular sequence, that zoom level will always be used for that sequence (unless you change it again). However, whenever the Sequence Editor creates a new sequence, it will use some default zoom level settings. If you prefer some particular zoom level, you probably do not want to zoom in or out every time that you create a sequence. So, the Zoom Preferences submenu (of the [Preferences submenu](#) of the [Edit menu](#)) allows you to save your current zoom level settings as defaults, by selecting "Save Zoom Preferences".

Later, when the Sequence Editor creates a new sequence, it will default to the zoom level settings that you had saved.

If you change the zoom level on a sequence, and want to get back to your saved default zoom level settings, the Zoom Preferences submenu also provides a way to do this, by selecting "Restore Zoom Preferences".



The Zoom Preferences submenu

5.3.4.3 The View Menu

The [Light-O-Rama Sequence Editor's](#) View menu contains items that enable you to customize how the Sequence Editor appears and how it displays [sequences](#), as well as to view certain information about

sequences.

The following items appear on the Sequence Editor's View menu:

- [Channel Buttons](#)
- [Channel Button Colors](#)
- [Time Scale](#)
- [Wave Form](#)
- [Animation](#)
- [Video](#)
 - [Show Videos](#)
 - [Show Audio Visualizations](#)
 - [Full Screen](#)
- [Fades](#)
- [Sequence Info](#)
- [Track Info](#)
- [Cell Info](#)
- [Zoom Rows](#)
- [Zoom Columns](#)
- [Tool Bars](#)
- [Tools Panel](#)
- [Refresh](#)

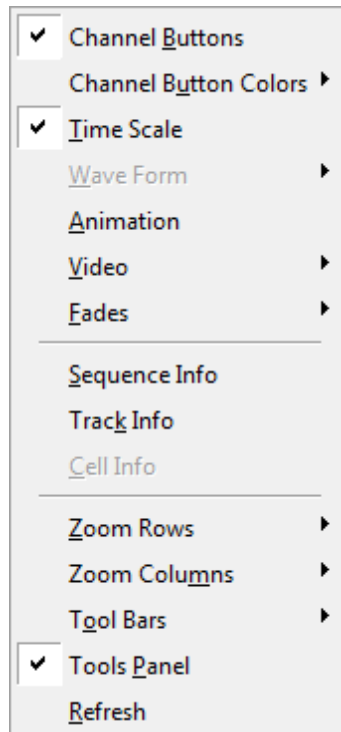

The View menu

Channel Buttons

If this option is enabled, the [channel buttons](#) of the active [sequence](#) will be displayed. Multiple sequences can be open in the [Sequence Editor](#) at the same time, and this option can be set independently for each of them.

You can also control this using the "[View Channel Buttons](#)" button on the [Standard toolbar](#), or by clicking on the thick grey vertical bar between the sequence's grid and the channel buttons.

You can control whether or not this option is enabled by default via "[View Channel Buttons by Default](#)" on the [Display Preferences dialog](#).

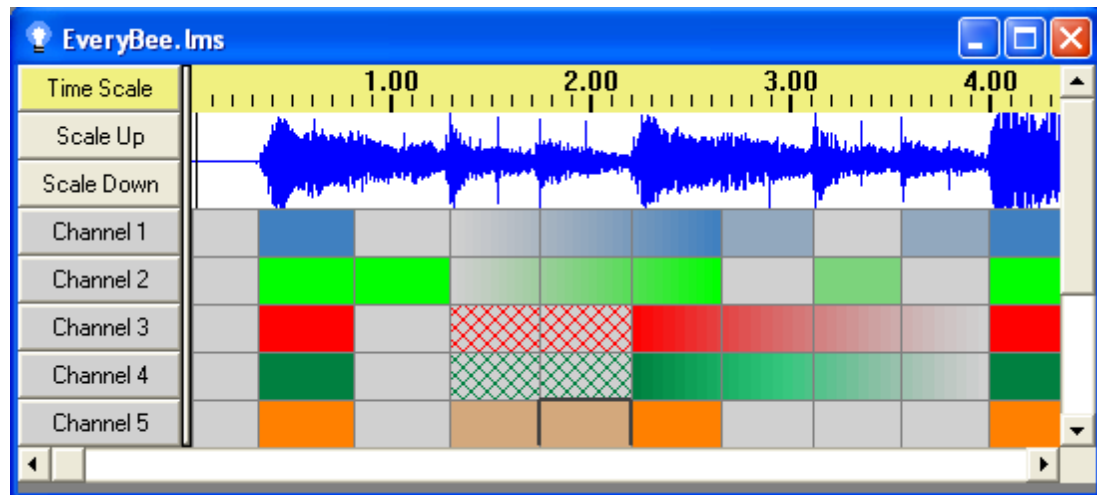

A sequence, with channel buttons displayed

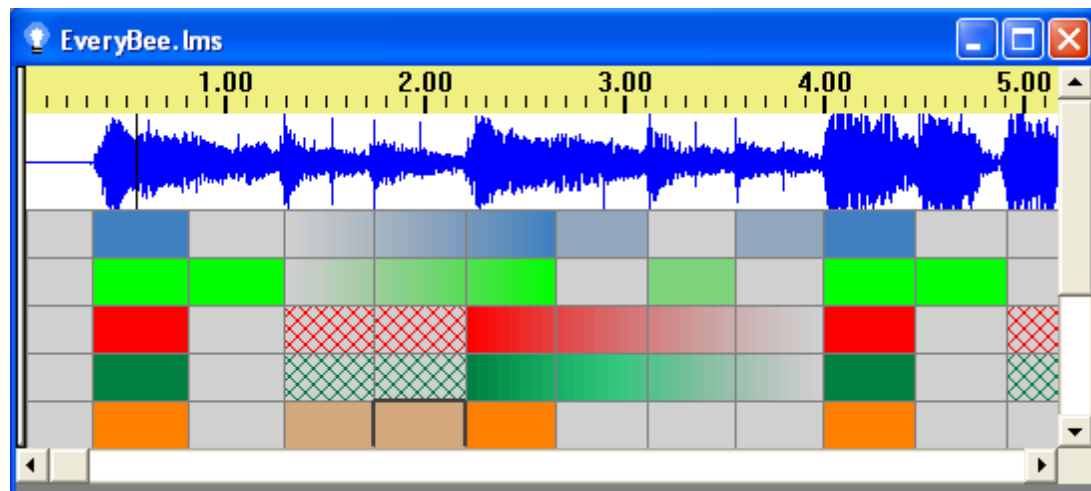

The same sequence, without channel buttons displayed

Channel Button Colors

This menu enables control over the colors of [channel buttons](#) while the sequence is not playing (note: for control over them while playing, see "[Vary Color of Channel Buttons](#)" on the [Play menu](#)). There are three options: "None", "Cell", and "Full":

- **None:** If this option is selected, channel buttons will all show the same grey color, except for those of [RGB channels](#), which will show black.
- **Cell:** If this option is selected, each channel button will show the color of its [channel](#) at the time of the start of the currently selected cell or cells.

- **Full:** If this option is selected, each channel button will show the full color of its channel.

Time Scale

If this option is enabled, a time scale will be displayed at the top of each [sequence](#). Multiple sequences can be open in the [Sequence Editor](#) at the same time, and this option can be set independently for each of them.

Clicking and dragging on the time scale will set the [freeform play range](#); clicking without dragging will clear the freeform play range (if one had been set).

You can also control this using the "[View Time Scale](#)" button on the [Standard toolbar](#).

You can control whether or not this option is enabled by default via "[View Time Scale](#)" on the [Display Preferences dialog](#).

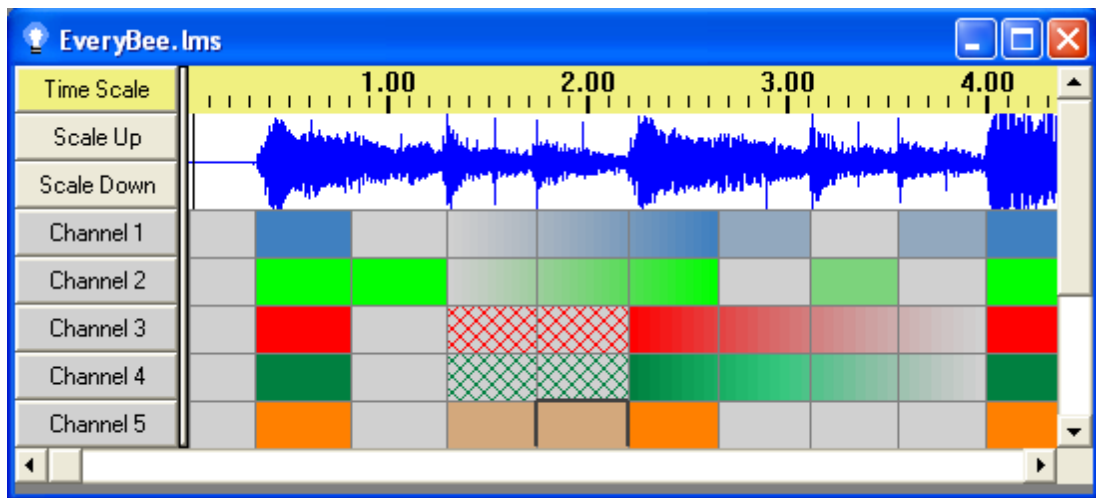

A sequence, with a time scale displayed at its top

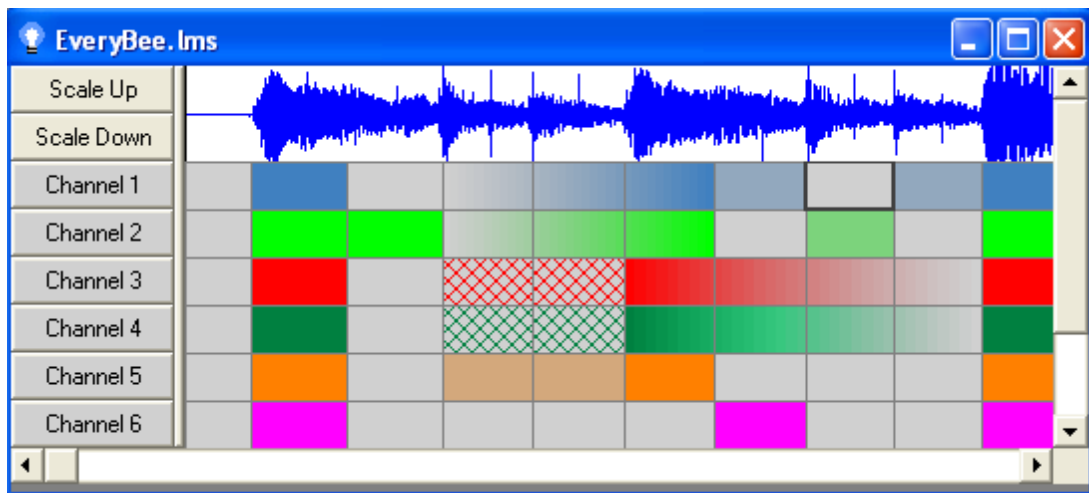

The same sequence, with no time scale displayed

Wave Form

This submenu of the [View menu](#) can be used to display a [waveform](#) of the audio of a [musical sequence](#) (although this is not supported for all types of media files). Three modes can be selected: full height, half height, and off.

Changing between full height and half height will cause all waveforms in all open sequences to be displayed in the new manner, and Light-O-Rama will remember the choice for future waveforms. Changing between either of those and "off" will only update the currently active sequence. To control whether waveforms are off or not by default, use [View Wave Form by Default](#) of the [Display Preferences dialog](#).

You can also toggle between "off" and whichever of "half height" and "full height" was last selected by using the [View Wave Form button](#) on the [Standard Toolbar](#).

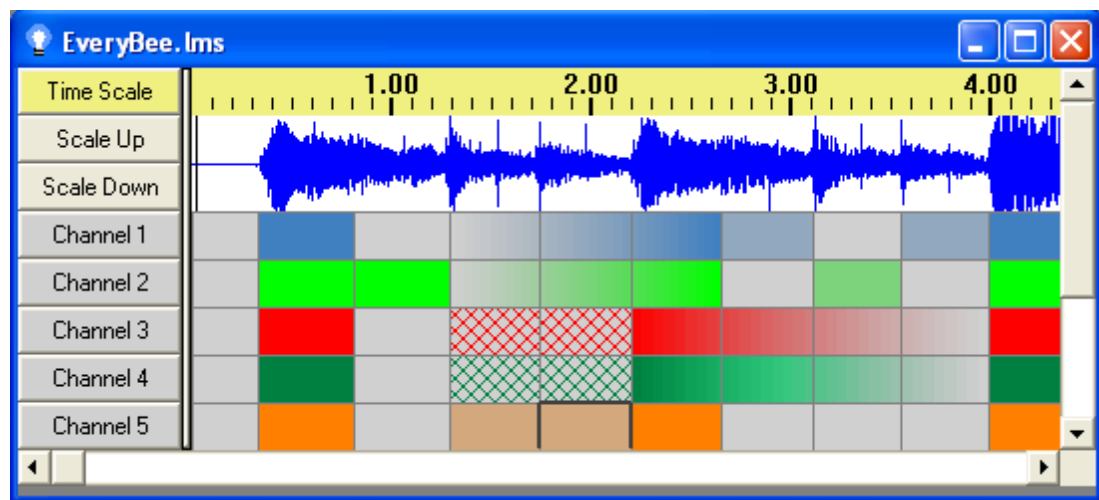

A sequence, with a wave form displayed at full height

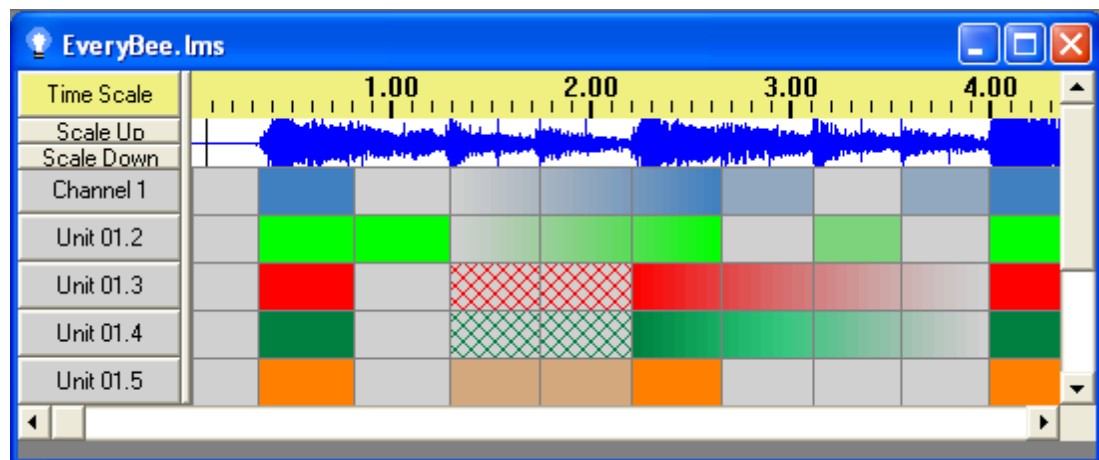

The same sequence, with the wave form displayed at half height

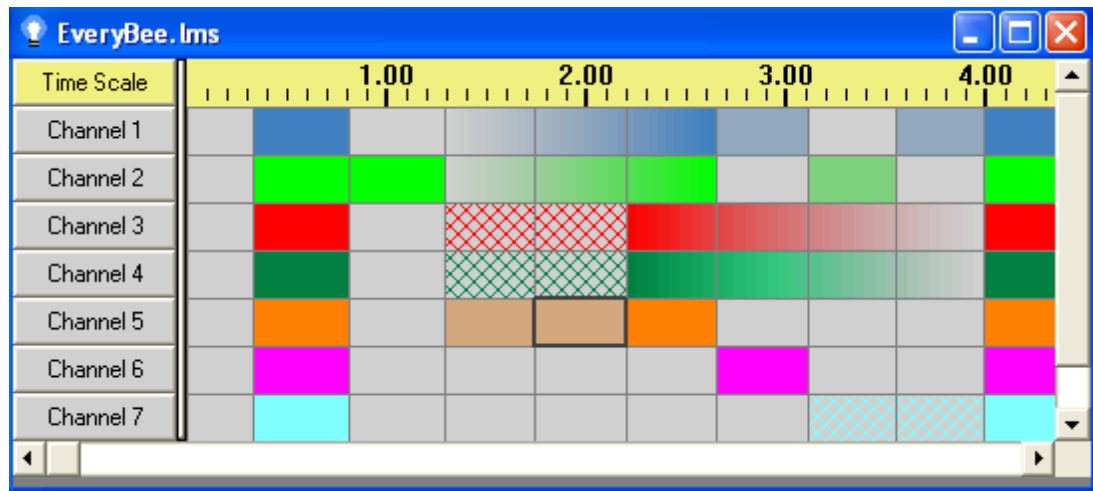

The same sequence, with no wave form displayed

Animation

If this option is enabled, the [animation](#) of the current [sequence](#) will be displayed. Multiple sequences can be open in the [Sequence Editor](#) at the same time, and this option can be set independently for each of them.

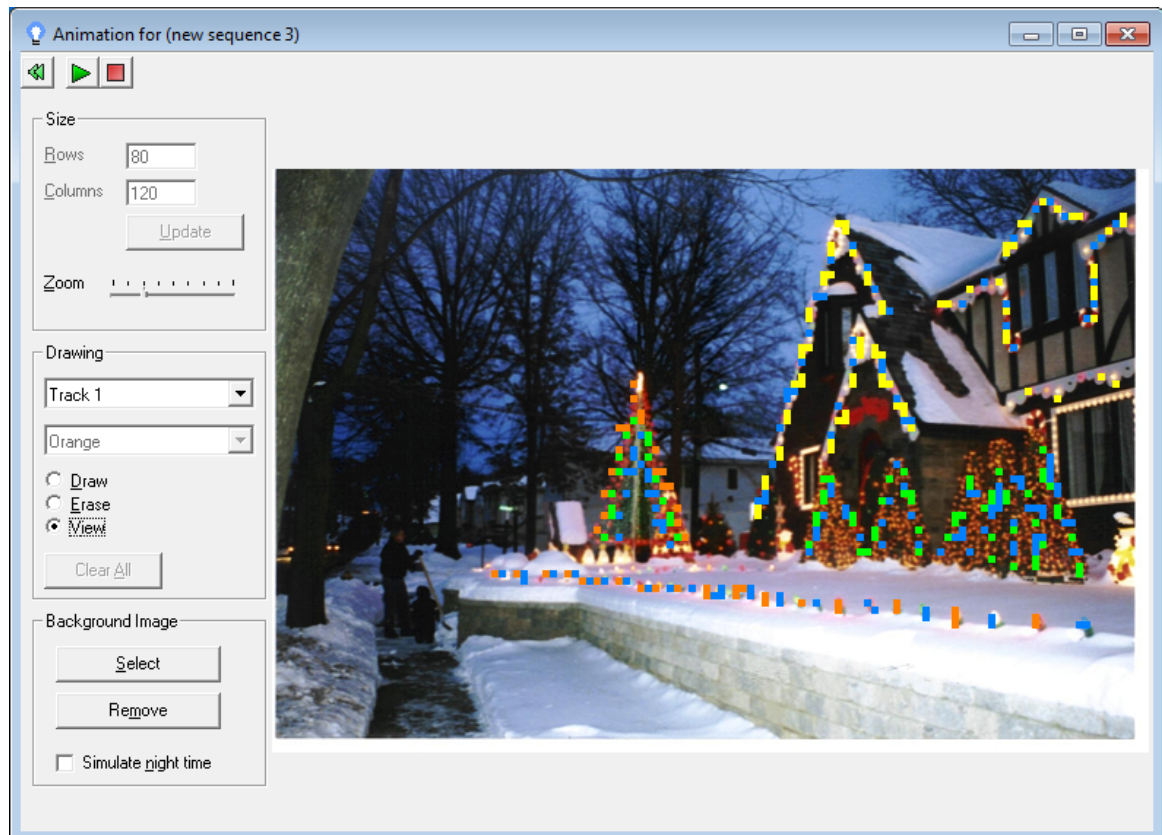

The animation for a sequence

Video

This submenu of the [View menu](#) enables you to specify if and how the [Sequence Editor](#) will display videos during play:

- [Show Videos](#)
- [Show Audio Visualizations](#)
- [Full Screen](#)

Show Videos

If this option is enabled, then whenever the [Sequence Editor](#) plays a [musical sequence](#) based on a video file, the video will be displayed during play.

You can control whether or not this option is on by default via "[Display Videos](#)" on the [Video Preferences dialog](#). That also controls whether videos will be displayed during [shows](#) by the [Show Player](#).

Show Audio Visualizations

If this option is enabled, then whenever the [Sequence Editor](#) plays a [musical sequence](#) based on an audio file, a visualization of the audio will be displayed during play.

You can control whether or not this option is on by default via "[Display Audio Visualizations](#)" on the [Video Preferences dialog](#). That also controls whether visualizations will be displayed during [shows](#) by the [Show Player](#).

Full Screen

If this option is enabled, then whenever the [Sequence Editor](#) displays a video or an audio visualization, it will do so in full screen mode.

You can control whether or not this option is on by default via "[Use Full Screen Mode](#)" on the [Video Preferences dialog](#). That also controls whether full screen mode will be used during [shows](#) by the [Show Player](#).

Fades

When [fade](#) or [intensity lighting effects](#) are displayed in the [Sequence Editor](#), they are displayed in one of two ways: "as ramps" or "as colors". You can use the Fades submenu of the [View menu](#) to control which is used.

When viewed "as colors", fades and intensities will be displayed as gradually varying shades between light grey (which indicates that the [channel](#) is off, i.e. the intensity is zero) and the color assigned to the channel (which indicates an intensity of 100%, i.e. full brightness).

When viewed "as ramps", they are instead displayed as partially filling in their cells with the color of the channel, to a degree based upon the intensity.

Neither of these settings have any effect on the behavior of your actual lights; they only affect how the Sequence Editor displays these lighting effects in a [sequence's](#) grid.

You can control which is used by default via "[View Fades as Ramps by Default](#)" on the [Display](#)

[Preferences menu.](#)

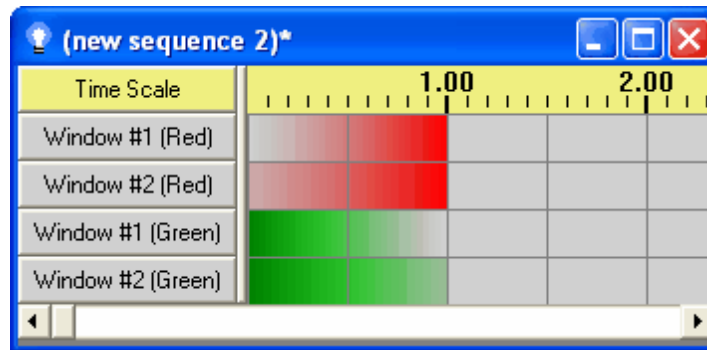

A sequence with fades viewed using colors

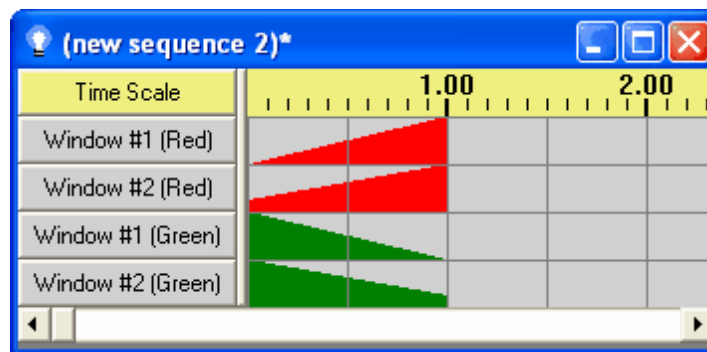

The same sequence, with fades viewed as ramps

Sequence Info

Selecting "Sequence Info" from the [View menu](#) will cause various information about the active [sequence](#) to be displayed:

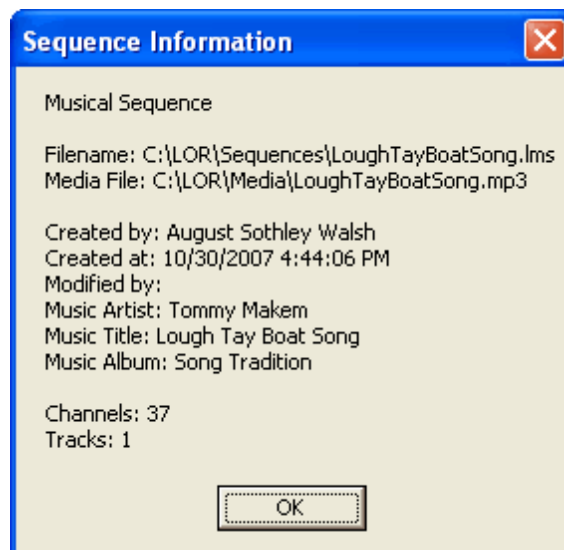

Sequence info

Track Info

Selecting "Track Info" from the [View menu](#) will cause various information about the active [track](#) in the active [sequence](#) to be displayed:

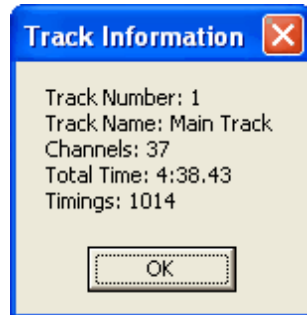

Track info

Cell Info

Selecting "Cell Info" from the [View menu](#) will cause various information about the currently selected cell to be displayed.

To use "Cell Info", there must be only a single cell currently selected. However, if the cell contains multiple [lighting effects](#), all of them will be displayed, and if any of them fall partially outside of the cell, their entire lengths will be indicated, not just the portions that coincide with the cell:

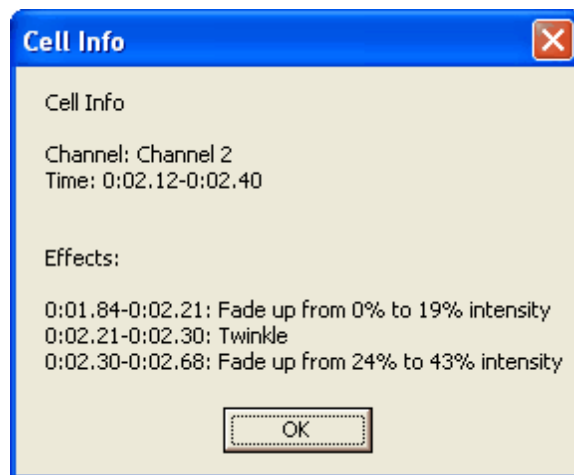

Cell info

Zoom Rows

When the [Sequence Editor](#) displays a [sequence](#), it is represented as a grid. Rows in the grid represent [channels](#). You can zoom in and out on the channels by using the Zoom Rows submenu of the [View menu](#).

You can also accomplish this using the zoom buttons on the [Standard toolbar](#).

Whatever zoom level you set for a sequence will always be used for that sequence (until you change it again), but if you have a zoom level that you like, you may want to save it using the [Zoom Preferences menu](#). Doing so will cause the Sequence Editor to use that zoom level by default

whenever you create a sequence.

See also "[Zoom Columns](#)", to zoom time in and out.

Zoom Columns

When the [Sequence Editor](#) displays a [sequence](#), it is represented as a grid. Columns in the grid represent time, bound by [timings](#). You can zoom time in and out by using the Zoom Columns submenu of the [View menu](#).

You can also accomplish this using the zoom buttons on the [Standard toolbar](#).

Whatever zoom level you set for a sequence will always be used for that sequence (until you change it again), but if you have a zoom level that you like, you may want to save it using the [Zoom Preferences menu](#). Doing so will cause the Sequence Editor to use that zoom level by default whenever you create a sequence.

See also "[Zoom Rows](#)", to zoom channels in and out.

Tool Bars

The [Light-O-Rama Sequence Editor](#) has two toolbars: the [Standard toolbar](#) and the [Tools toolbar](#). You can control whether each of these is displayed using the Tool Bars submenu of the [View menu](#).

Tools Panel

You can control whether or not the [Sequence Editor](#) displays the [Tools panel](#) via the "Tools Panel" menu item on the [View menu](#).

Refresh

Occasionally during play, the display of a [sequence's](#) grid may seem to blank out. This is typically caused when your computer happens to do something unrelated to Light-O-Rama, and temporarily takes the focus away from the [Sequence Editor](#). The sequence itself is not affected, nor are the actual lights - only the Sequence Editor's display of the sequence is - and the display is typically returned to normal when play reaches the next screen (or stops). However, if you do not wish to wait for that, you can select "Refresh" from the [View menu](#), or simply hit the F5 key, to manually refresh the display.

5.3.4.4 The Tools Menu

The [Light-O-Rama Sequence Editor's](#) Tools menu contains items enabling you to choose which [lighting effects](#) will be applied when you edit [sequences](#) (via the [mouse](#) or the [keyboard](#)), settings for those effects, and several wizards that can be used to change sequences in various ways.

The following options are available on the Tools menu:

- [Effect Tools](#)
 - [Select](#)
 - [Toggle](#)
 - [Twinkle](#)
 - [Shimmer](#)

- [On](#)
- [Off](#)
- [Set Intensity](#)
- [Fade Up](#)
- [Fade Down](#)
- [Intelligent Fade](#)
- [Fill](#)
- [Chase](#)
- [Color Fade](#)
- [Paint Sequence](#)
- [DMX Intensity](#)
- [Custom](#)
- [Effect Tool Settings](#)
 - [Custom Settings](#)
 - [Background Effects](#)
 - [Foreground Effects](#)
 - [Intensity Tool Settings](#)
 - [Intensity Tool Options](#)
 - [Fade Tool Settings](#)
 - [Fade Tool Options](#)
 - [Load Intensities and Fades from Current Sequence](#)
- [Channel Configuration](#)
- [Wizards](#)
 - [Beat Wizard](#)
 - [MIDI Wizard](#)
 - [Tapper Wizard](#)
 - [VU Wizard](#)

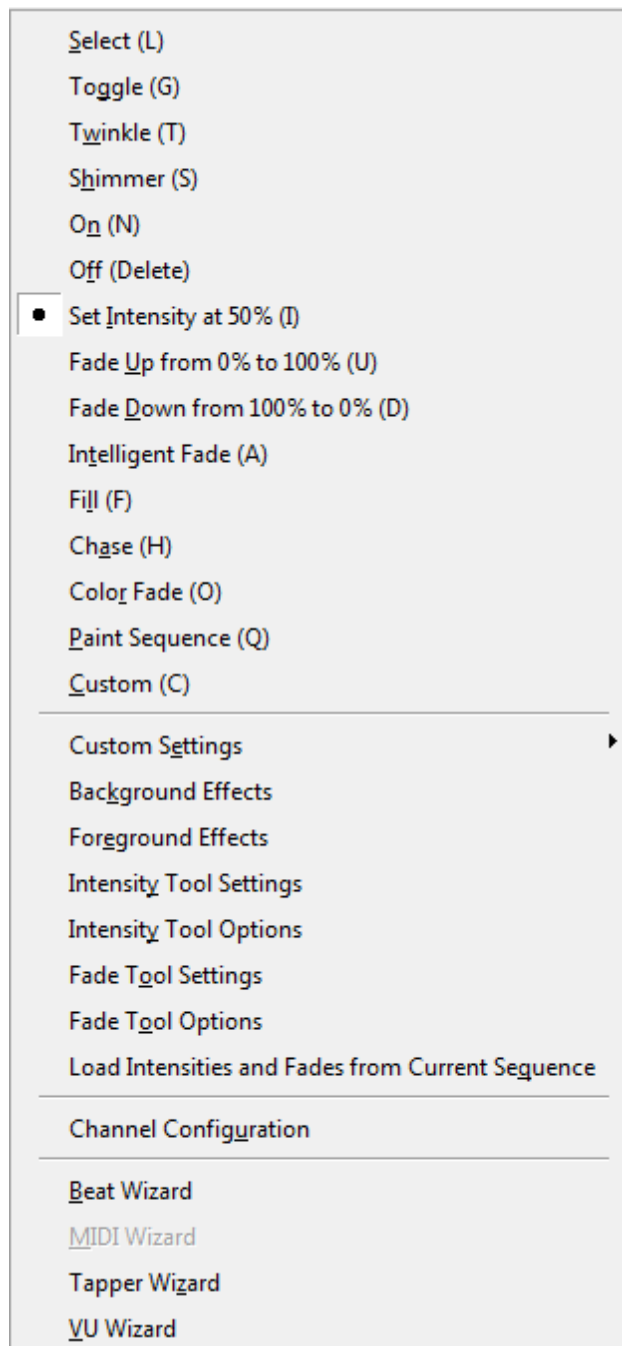

The Tools Menu

Effect Tools

The first group of items on the [Tools menu](#) enables you to choose the tool that will be used whenever you select a cell or cells [using the mouse](#), or hit the enter key on the [keyboard](#). The selected tool will generally apply a [lighting effect](#) to the selected cell or cells (an exception to this is the [Fill](#) tool, which applies a fill to the cell that you click on, and any cell that you then drag to, rather than to the selected cell or cells).

Only one of these tools can be enabled at any given time; enabling one will automatically disable the others.

You can also choose the current effect tool using the [Tools toolbar](#).

The following effect tools can be enabled:

- [Select](#)
- [Toggle](#)
- [Twinkle](#)
- [Shimmer](#)
- [On](#)
- [Off](#)
- [Set Intensity](#)
- [Fade Up](#)
- [Fade Down](#)
- [Intelligent Fade](#)
- [Fill](#)
- [Chase](#)
- [Color Fade](#)
- [Paint Sequence](#)
- [DMX Intensity](#)
- [Custom](#)

Select

If this [effect tool](#) is enabled on the [Tools menu](#), then clicking on a cell or cells in a [sequence's](#) grid will simply select those cells. No [lighting effect](#) will be applied, nor will any be applied by hitting the enter key.

Toggle

If this [effect tool](#) is enabled on the [Tools menu](#), then clicking on a cell or cells in a [sequence's](#) grid, or hitting the enter key, will turn individual parts of the selection [on or off](#). Each portion of the selection that had been on will be turned off, and every other portion will be turned on. Note that the latter includes not just portions of the selection that had been off, but also those that had been [twinkles](#), [fades](#), [shimmers](#), and [intensities](#).

Twinkle

If this [effect tool](#) is enabled on the [Tools menu](#), then clicking on a cell or cells in a [sequence's](#) grid, or hitting the enter key, will apply the [twinkle](#) effect to the selected cells, making the selected [channels](#) blink on and off randomly during the selected time.

Shimmer

If this [effect tool](#) is enabled on the [Tools menu](#), then clicking on a cell or cells in a [sequence's](#) grid, or hitting the enter key, will apply the [shimmer](#) effect to the selected cells, making the selected [channels](#) rapidly blink on and off in unison during the selected time.

On

If this [effect tool](#) is enabled on the [Tools menu](#), then clicking on a cell or cells in a [sequence's](#) grid, or hitting the enter key, will apply the [on](#) effect to the selected cells, making the selected [channels](#) turn on at full brightness during the selected time.

Off

If this [effect tool](#) is enabled on the [Tools menu](#), then clicking on a cell or cells in a [sequence's](#) grid, or hitting the enter key, will apply the [off](#) effect to the selected cells, making the selected [channels](#) turn completely off during the selected time.

Set Intensity

If this [effect tool](#) is enabled on the [Tools menu](#), then clicking on a cell or cells in a [sequence's](#) grid, or hitting the enter key, will apply the [set intensity](#) effect to the selected cells, making the selected [channels](#) turn on at a specified percentage of their full brightness during the selected time.

The exact percentage of brightness used can be chosen via the [Intensity Tool Settings dialog](#).

Fade Up

If this [effect tool](#) is enabled on the [Tools menu](#), then clicking on a cell or cells in a [sequence's](#) grid, or hitting the enter key, will apply the [fade up](#) effect to the selected cells, making the selected [channels](#) gradually increase in brightness during the selected time.

The exact levels of brightness that the fade will start and end at can be chosen via the [Fade Tool Settings dialog](#).

Fade Down

If this [effect tool](#) is enabled on the [Tools menu](#), then clicking on a cell or cells in a [sequence's](#) grid, or hitting the enter key, will apply the [fade down](#) effect to the selected cells, making the selected [channels](#) gradually decrease in brightness during the selected time.

The exact levels of brightness that the fade will start and end at can be chosen via the [Fade Tool Settings dialog](#).

Intelligent Fade

The Intelligent Fade tool is similar to the [Fade Up](#) and [Fade Down](#) tools, but it can create either a [fade up](#) effect or a [fade down](#) effect, as well as applying a [fill](#). It will create a fade up when you use it by clicking and dragging left-to-right, or a fade down when clicking or dragging right-to-left (or, if you are using the [keyboard](#), fade up or fade down depends upon whether you expanded the selection left-to-right or right-to-left).

If you click without dragging, it will apply a fill. That is, if you click on an empty area of the grid, it will change that area to be a fade from the preceding intensity to the following intensity. For example, if a fade up from 10% to 40% is followed by the lights being off, which is followed by a fade up from 20% to 80%, then clicking on the area where the lights are off will make it into a fade down from 40% to 20%.

Fill

The Fill tool can be used to create smooth fades from one effect to another. For example, if a [fade up](#) from 10% to 40% is followed by the lights being [off](#), which is followed by a fade up from 20% to 80%, then applying the Fill tool on the area where the lights are off will make it into a [fade down](#) from 40% to 20%:



Before a fill...



... and after a fill

It can also be used in a similar manner on [RGB channels](#) to smoothly fade from one color to another.



Before a fill...



... and after a fill

The Fill tool does not do anything when used on cells that are not completely off.

When used with the [mouse](#), the Fill tool works slightly differently than other [effect tools](#). With most tools, clicking a cell will change the selected area of the sequence grid to be that cell, and dragging (with the mouse still clicked) will expand the selection. Only after the mouse button is let up will the tool be applied to the selection.

The Fill tool, on the other hand, is applied to the effect that you click on, immediately when you click down, and to any effect that you subsequently drag to (with the mouse still clicked down). It does not change the selected area of the sequence grid in any way. This fact, plus the fact that the Fill tool does not affect effects other than off effects, hopefully makes it easy to apply a wide range of fills quickly, simply by clicking and dragging to the appropriate spots.

The [Intelligent Fade tool](#) and the [Color Fade tool](#) can also be used to apply fills in certain situations.

Chase

The Chase tool can be used to take a pattern and "chase" it through several [channels](#) over a time range. For example:

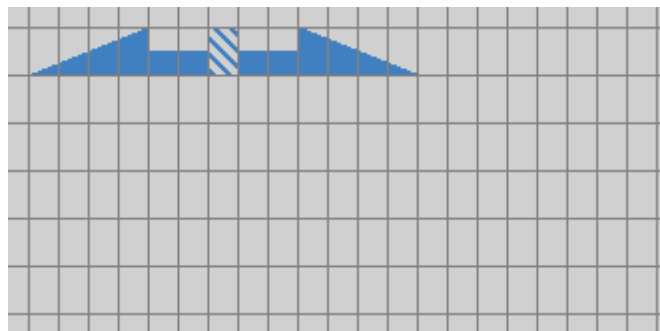

Before a chase...

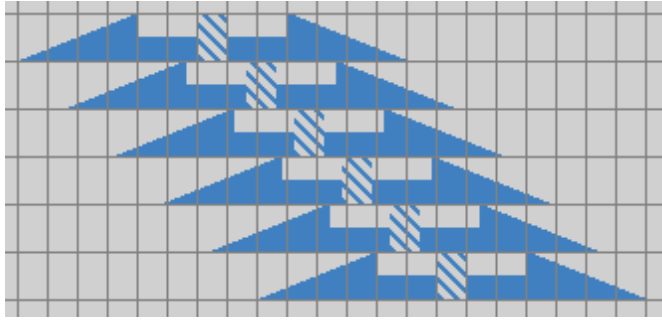

... and after a chase

Exactly what is chased, and where it is chased to, depends upon how you click-and-drag (or, if using the [keyboard](#), how you expanded the selection). The lighting [effects](#) in the corner that you started dragging from will be chased to the corner that you finished dragging to so that, for example, you could chase effects "up" or "down" through channels.

The effects that are chased will include everything up to and including the last non-off lighting effect in the channel that you start dragging from (or, if dragging backwards, everything from the first non-off lighting effect).

The Chase tool can also be used on [RGB channels](#):

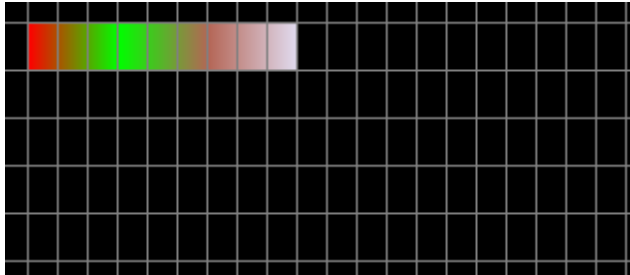

Before an RGB chase...

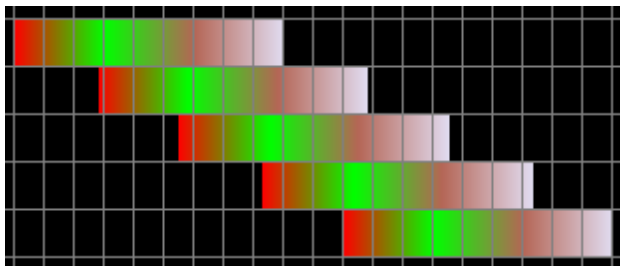

... and after an RGB chase

The Chase tool pays attention to the [Paste from Foreground clipboard](#) option, so that you can chase a pattern without overwriting existing effects with "off" effects. For example, consider the following sequence, and imagine that you want to chase the second [fade up](#) in the first channel:

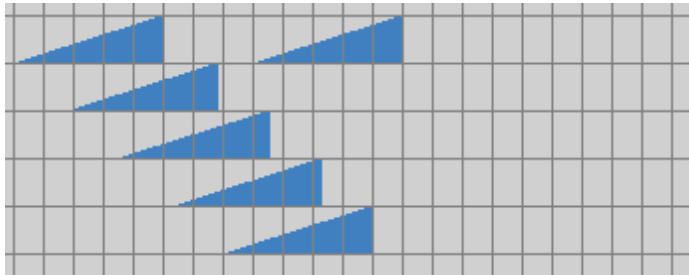

Before chasing the second fade

If you did not have "Paste from Foreground" turned on, the chase would overwrite the ends of the existing fades in some of the other channels:

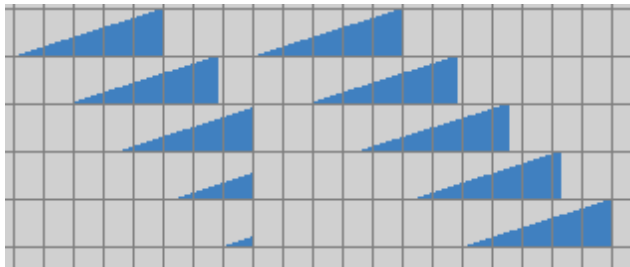

After chasing the second fade, without "Paste from Foreground"

But with "Paste from Foreground" turned on, the existing effects would be kept in place:

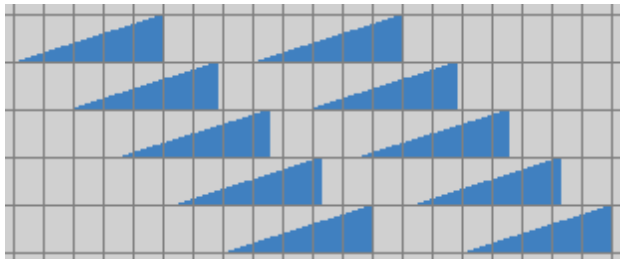

After chasing the second fade, with "Paste from Foreground"

Color Fade

The Color Fade tool can be used to apply colors to [RGB channels](#). Selecting the Color Fade tool opens the Color Fade tool window, which enables you to specify the colors to be used (note, however, that the colors as displayed on your screen will not necessarily match those shown by your actual lights; you may have to experiment to determine colors that wind up looking the way you want, and different RGB devices may show different colors when sent the same intensities):

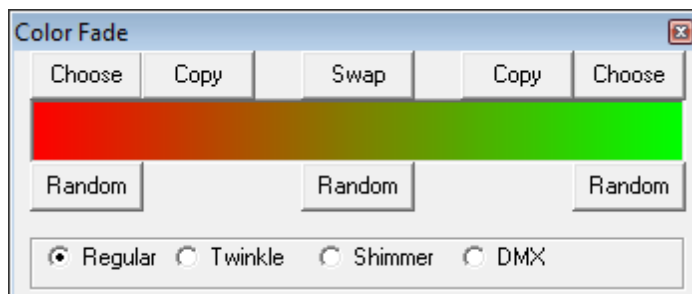

The Color Fade tool window

With the Color Fade tool selected, clicking and dragging an area of an RGB channel or multiple RGB channels will cause that area to become those colors:



Applying a color fade to an RGB channel

If you drag backwards, however, the colors will be applied in reverse order (this also happens if you are using the [keyboard](#), and expand the selection from right to left instead of left to right):



Applying a color fade to an RGB channel by dragging backwards

Clicking (as opposed to clicking-and-dragging) on an empty area will cause the Color Fade tool to perform a [fill](#), smoothly fading from the preceding color to the following color:



Before clicking the empty area...



... and after clicking the empty area

The Color Fade tool window gives several ways to select the colors to be used:

- The "Choose" buttons on either side will open a color picker dialog to specify the color for that side
- The "Copy" button on either side will copy the color from the opposite side
- The "Swap" button will move the two colors to their opposite sides
- The "Random" buttons on either side will choose a random color for that side
- The "Random" button in the middle will choose random colors for both sides

The Color Fade tool window also enables you to choose what kind of effect should be applied. For example, here is a [twinkling](#) color fade:

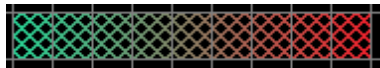

A twinkling color fade

A note regarding DMX color effects: The Color Fade tool allows you to specify that DMX effects should be used. However, as of the time of this writing, LOR hardware does not support DMX effects which change intensity (for example, a fade up), and so unless the underlying DMX effects caused by using the Color Fade tool stay at a constant intensity, they will be automatically converted to regular fades when they are sent to the controllers. That is, for example, a DMX fade from 0 to 255 will be converted to a regular fade from 0% to 100%. So, the Color Fade tool will not give as fine-grained control over DMX as you may think.

However, if you make your sequence using DMX fades now, and in the future LOR hardware is updated to support them, then your sequence will take advantage of this.

Paint Sequence

The Paint Sequence tool can be used to paint some or all of the [effects](#) from another [sequence](#) into

the current sequence, in a variety of ways.

When this tool is selected, the Paint Sequence dialog will open:

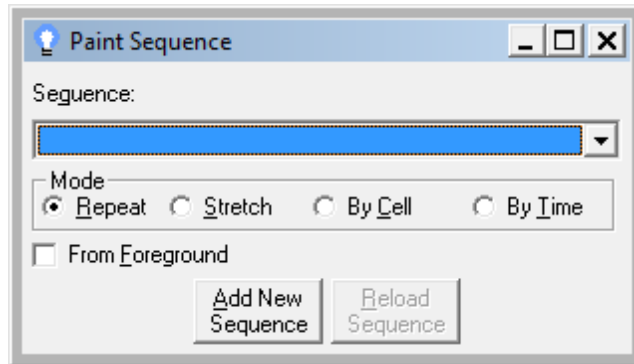

The Paint Sequence dialog

To select a sequence to paint from, first click on the "Add New Sequence" button. This will open up a file browser, allowing you to select the sequence in question. After you do so, it will be added to the "Sequence" dropdown list. Many sequences can be added to the dropdown list, and after a sequence is in the list, you can choose to paint from it simply by selecting it in the list (rather than by clicking "Add New Sequence" every time).

If the Paint Sequence tool is applied to a time range in a sequence, it will paste effects from the first [track](#) of the sequence selected via the Paint Sequence dialog into that time range of the other sequence. All [channels](#) in the Paint Sequence dialog's sequence's first track are used, regardless of how many channels are selected in the sequence which is being painted into.

The exact way that the effects are painted depends upon the selected "Mode", and whether or not the "From Foreground" option is selected. These are handled much like the similar [modes](#) and [options](#) for pasting from [clipboards](#). For example, if the "[Repeat](#)" option is selected, the effects will be painted by repeating them over and over again until the entire selected time range has been filled (or, if the selected time range is shorter than the sequence being painted from, however much of the effects fit in that time range will be used).

Note that the pasted effects truly become a part of the sequence that they are painted into; they are not linked back to the original sequence that they were painted from. That is, if you ever change the effects in the sequence that they were painted from, this change will not automatically be reflected in the sequence that you painted into.

Also, once a sequence has been added to the dropdown list via the "Add New Sequence" button, painting from that sequence will use the effects as they were at the time the sequence was added. That is, if you change the effects that are in a sequence in the dropdown list, and save that sequence, painting from that sequence will still use the old effects. If you want to use the new effects, then select that sequence in the dropdown list, and then click the "Reload Sequence" button.

As an example, consider the following sequences, the first selected in the Paint Sequence dialog, and the second to be painted into:

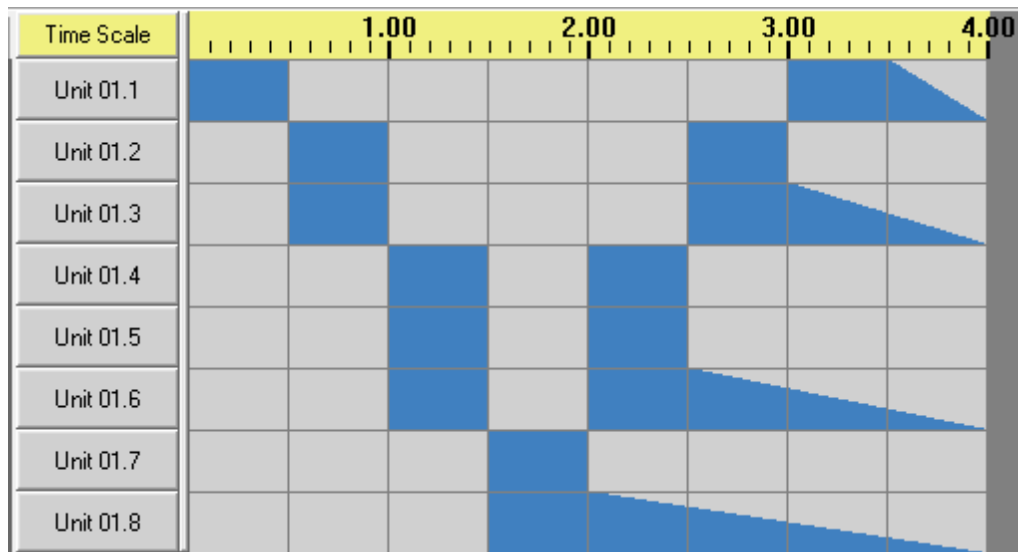

The sequence being painted from

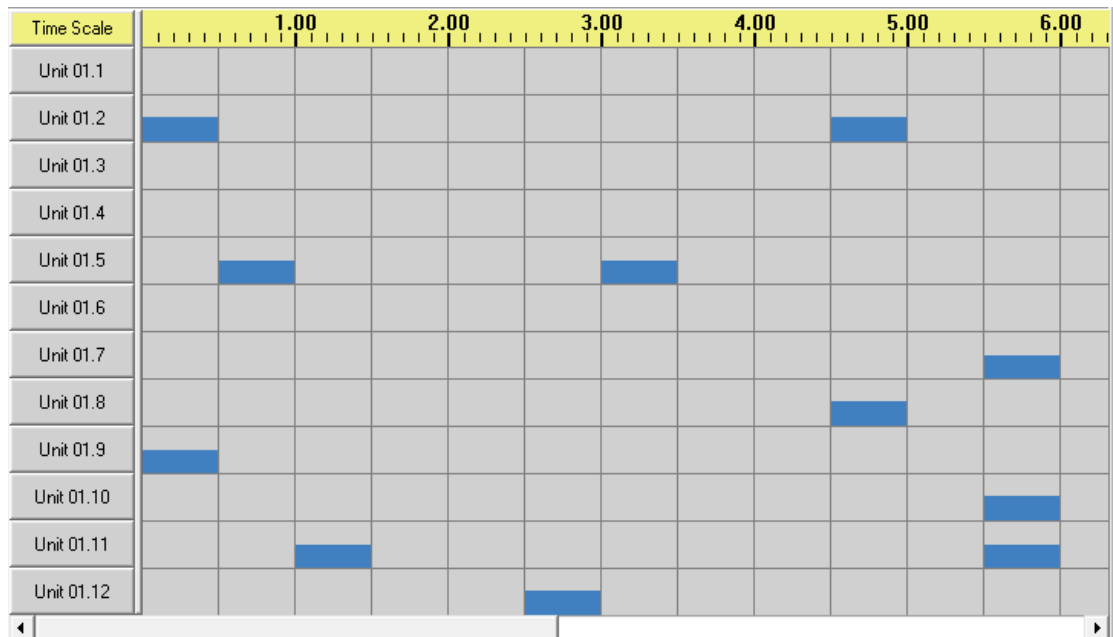

The sequence being painted into, before painting

If the area from 1.00 second to 6.00 seconds on channel "Unit 01.3" is selected in the sequence being painted into, and the selected Mode is "Repeat", with "From Foreground" turned off, the results will be the following:

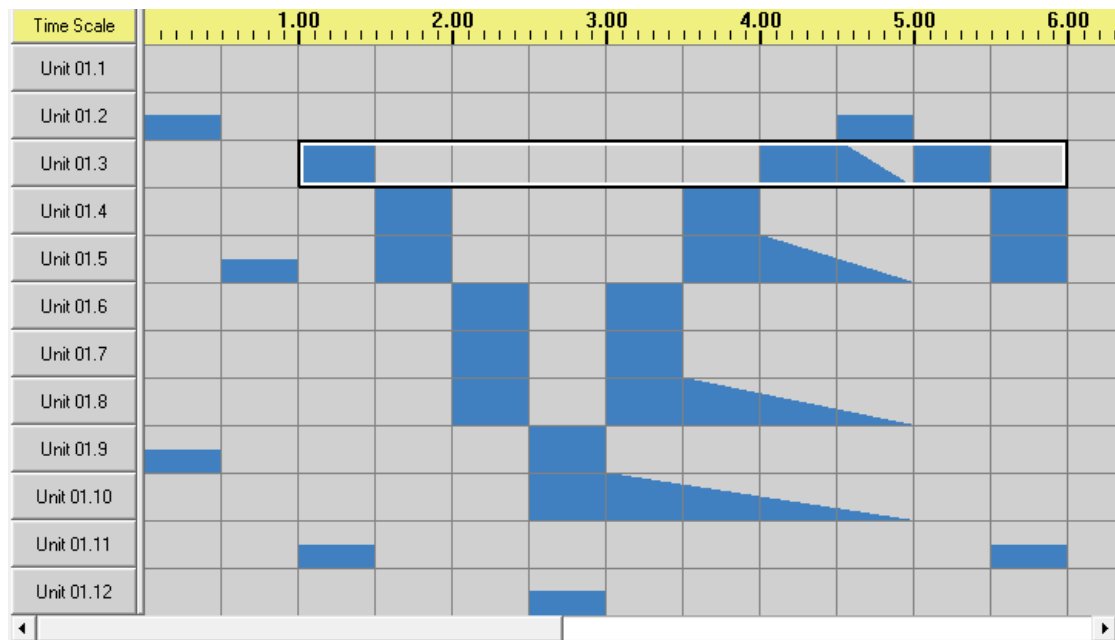

The sequence being painted into, after painting

Note that all eight channels from the first sequence were painted into the second sequence, despite the fact that only one channel was selected - the channel selection merely indicates the location to start pasting channels into.

Also note that because the selected time range was five seconds long, while the length of the sequence being painted from was only four seconds, the entire four seconds were painted (to time 1.00 through 5.00), followed by another copy of the first second (from time 5.00 to time 6.00). This is because the "Repeat" mode was selected; other modes will behave differently, as described in the similar [clipboard modes](#).

DMX Intensity

If this [effect tool](#) is enabled on the [Tools menu](#), then clicking on a cell or cells in a [sequence's](#) grid, or hitting the enter key, will apply the [DMX intensity](#) effect to the selected cells, allowing for 256 possible intensities (between 0 and 255), rather than 101 (between 0 and 100).

This tool is only available if [DMX editing](#) has been enabled.

Custom

If this [effect tool](#) is enabled on the [Tools menu](#), then clicking on a cell or cells in a [sequence's](#) grid, or hitting the enter key, will apply the current [custom tool](#) effect to the selected cells, for example making the selected channels twinkle while gradually decreasing in brightness during the selected time.

Effect Tool Settings

The [Tools menu](#) contains several settings that affect the behavior of the currently selected [effect tool](#) :

- [Custom Settings](#)

- [Background Effects](#)
- [Foreground Effects](#)
- [Intensity Tool Settings](#)
- [Intensity Tool Options](#)
- [Fade Tool Settings](#)
- [Fade Tool Options](#)
- [Load Intensities and Fades from Current Sequence](#)

Custom Settings

This submenu of the [Tools menu](#) allows you to select the behavior of the current [custom tool](#). For example, to make the current custom tool into a twinkling fading down tool, check "Twinkle" and "Fade Down" from this submenu.

Background Effects

Enabling this item on the [Tools menu](#) will turn on [background effects mode](#), which causes the current [effect tool](#) to apply only to those portions of the selection which are currently [off](#).

Background effects mode can also be turned on via the [Tools toolbar](#), or by hitting Shift-A on the [keyboard](#).

At most one of background effects mode and foreground effects mode can be enabled at the same time. Enabling one will automatically disable the other. However, using the keyboard, you can temporarily turn on either of them (and also regular effects mode) for the next keystroke only, using the A, O, and E keys, respectively.

Foreground Effects

Enabling this item on the [Tools menu](#) will turn on [foreground effects mode](#), which causes the current [effect tool](#) to apply only to those portions of the selection which are *not* currently [off](#).

Foreground effects mode can also be turned on via the [Tools toolbar](#), or by hitting Shift-O on the [keyboard](#).

At most one of background effects mode and foreground effects mode can be enabled at the same time. Enabling one will automatically disable the other. However, using the keyboard, you can temporarily turn on either of them (and also regular effects mode) for the next keystroke only, using the A, O, and E keys, respectively.

Intensity Tool Settings

This item on the [Tools menu](#) opens or closes the Intensity Tool Settings dialog, which allows you to choose what percentage of full brightness will be used when you apply the [set intensity tool](#) to cells in a [sequence](#).

The dialog has ten preset values that you can select from. If you want to use a value that is not among these ten, use the [Intensity Tool Options dialog](#) to change the available preset values (by choosing it from the Tools menu, or by pressing the "Edit" button on the Intensity Tool Settings dialog). The values of the presets can also be set using [Load Intensities and Fades from Current Sequence](#) on the Tools menu.

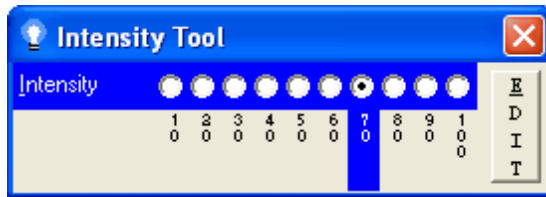

The Intensity Tool Settings dialog, with 70% intensity selected

Intensity Tool Options

This item on the [Tools menu](#) opens the Intensity Tool Options dialog, which allows you to set the values of the available presets on the [Intensity Tool Settings dialog](#).

The Intensity Tool Options dialog can also be opened by clicking the "Edit" button on the Intensity Tool Settings dialog.

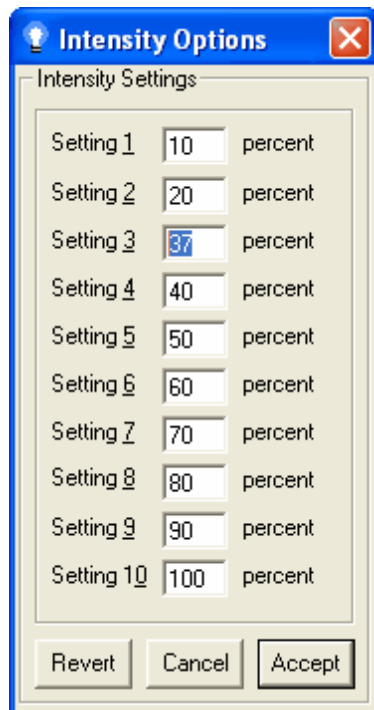

The Intensity Tool Options dialog

Fade Tool Settings

This item on the [Tools menu](#) opens or closes the Fade Tool Settings dialog, which allows you to choose what percentages of full brightness will be used when you apply the [fade up tool](#) or [fade down tool](#) to cells in a [sequence](#).

The dialog has ten preset values that you can select from, and the values for fade up and fade down can be selected independently. If you want to use a value that is not among these ten, use the [Fade Tool Options dialog](#) to change the available preset values (by choosing it from the Tools menu, or by pressing the "Edit" button on the Fade Tool Settings dialog). The values of the presets can also be set using [Load Intensities and Fades from Current Sequence](#) on the Tools menu.

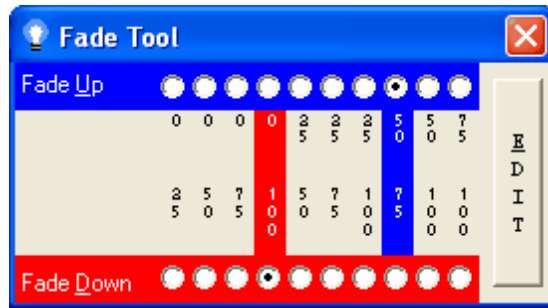

The Fade Tool Settings dialog, with fade up 50%-75% and fade down 100%-0% selected

Fade Tool Options

This item on the [Tools menu](#) opens the Fade Tool Options dialog, which allows you to set the values of the available presets on the [Fade Tool Settings dialog](#).

The Fade Tool Options dialog can also be opened by clicking the "Edit" button on the Fade Tool Settings dialog.

Choose upper and lower bounds for fade presets

Preset	Low Value	High Value
Preset 1	0 percent	25 percent
Preset 2	0 percent	50 percent
Preset 3	0 percent	75 percent
Preset 4	0 percent	100 percent
Preset 5	25 percent	50 percent
Preset 6	25 percent	75 percent
Preset 7	25 percent	100 percent
Preset 8	50 percent	75 percent
Preset 9	50 percent	100 percent
Preset 10	75 percent	100 percent

Revert Cancel Accept

The Fade Tool Options dialog

Load Intensities and Fades from Current Sequence

This item on the [Tools menu](#) can be used to automatically set the preset values available in the [Intensity Tool Settings dialog](#) and the [Fade Tool Settings dialog](#), based upon the most commonly used values in the current [sequence](#).

Channel Configuration

This item on the [Tools menu](#) opens the [Channel Configuration screen](#), which enables you to modify the settings of all of the [channels](#) in the current [sequence](#) (such as their names, colors, unit IDs, and circuit IDs).

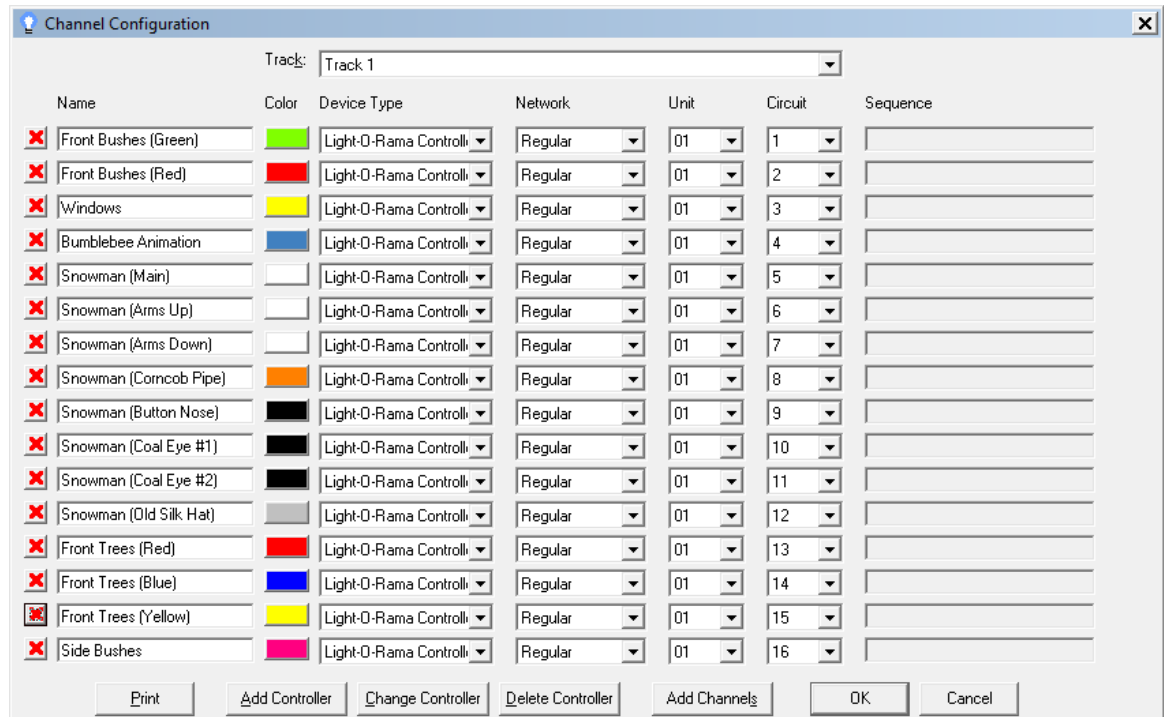

The Channel Configuration screen

Note that only channels, and not [RGB channels](#), are displayed in the Channel Configuration screen. However, the three constituent channels of an RGB channel (that is, the red, green, and blue channels of that RGB channel) are displayed in the Channel Configuration screen.

Wizards

The Tools menu can be used to launch several wizards that enable you to make changes to sequences in various ways:

- [Beat Wizard](#)
- [MIDI Wizard](#)
- [Tapper Wizard](#)
- [VU Wizard](#)

Beat Wizard

This item on the [Tools menu](#) opens the [Beat Wizard](#), which can be used to try to determine the tempo of a song, and insert [timings](#) and [effects](#) based upon it into the current [sequence](#).

The Beat Wizard is only available for [musical sequences](#), and not all types of media files are supported. Notably, video files and MIDI files are not supported.

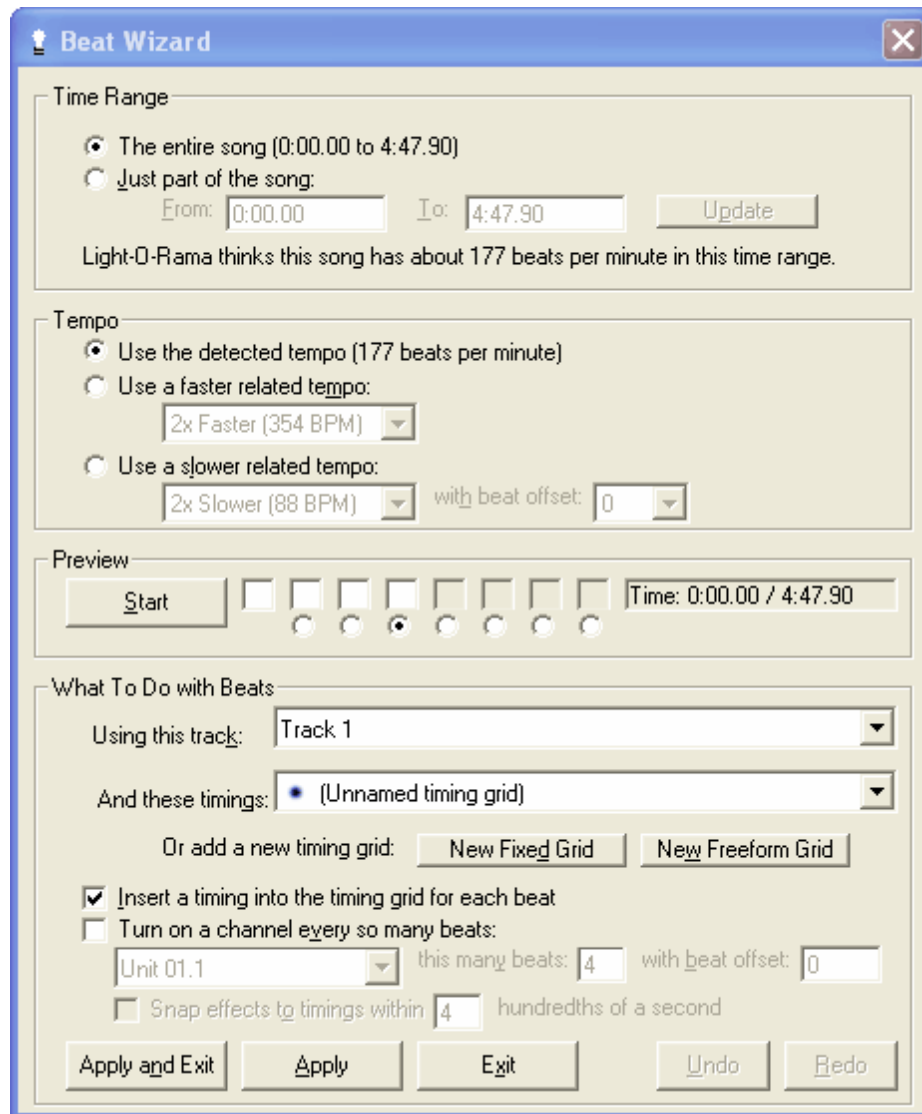

The Beat Wizard

MIDI Wizard

This item on the [Tools menu](#) opens the MIDI Wizard, which can be used to insert [timings](#) and [effects](#) into a [sequence](#) based upon the tempo of a MIDI file, or upon the individual notes played by instruments in that MIDI file.

The MIDI Wizard is only supported for [musical sequences](#) based upon MIDI files.

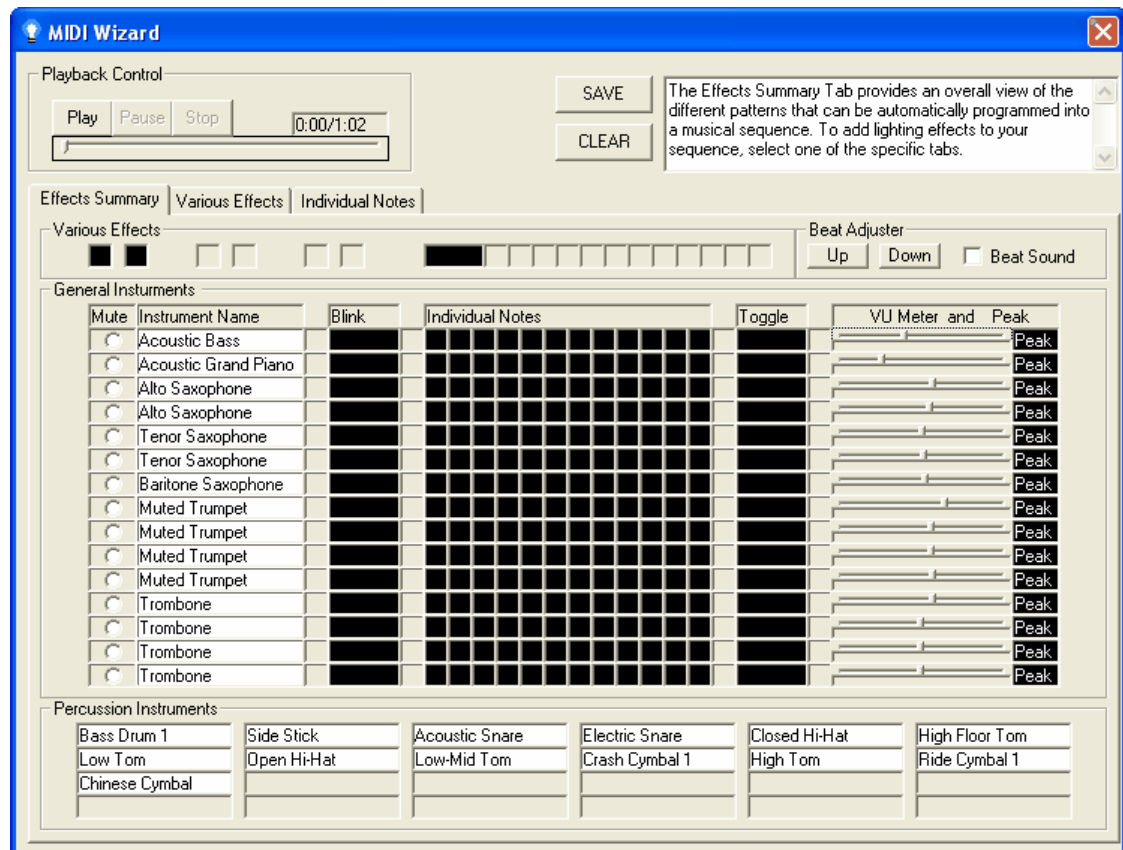

The MIDI Wizard

Tapper Wizard

This item on the [Tools menu](#) opens the [Tapper Wizard](#), which can play the sequence's song and record you as you tap along with it, and insert [timings](#) and [effects](#) based upon your taps into the current [sequence](#).

The Tapper Wizard is only supported for [musical sequences](#).

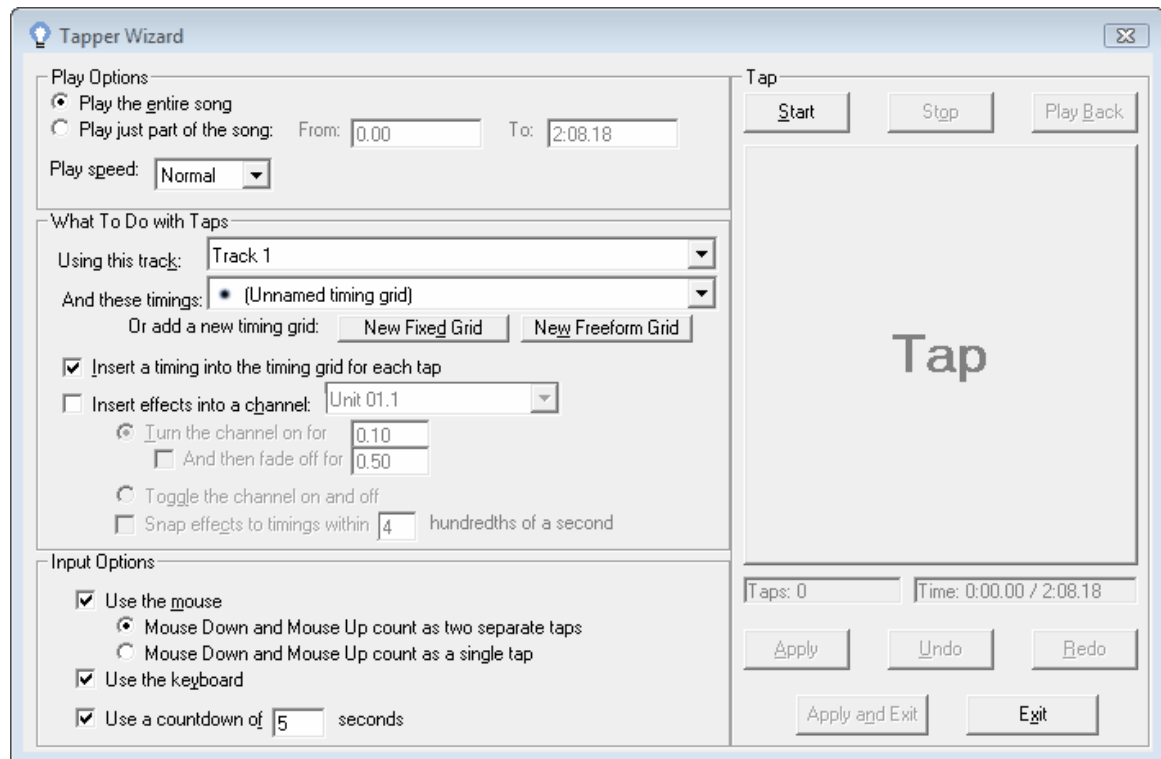

The Tapper Wizard

VU Wizard

This item on the [Tools menu](#) opens the [VU Wizard](#), which can be used to insert [timings](#) and [effects](#) based upon it into the current [sequence](#) based upon audio peaks in the song, much like a VU meter.

The VU Wizard is only available for [musical sequences](#), and not all types of media files are supported. Notably, video files and MIDI files are not supported.

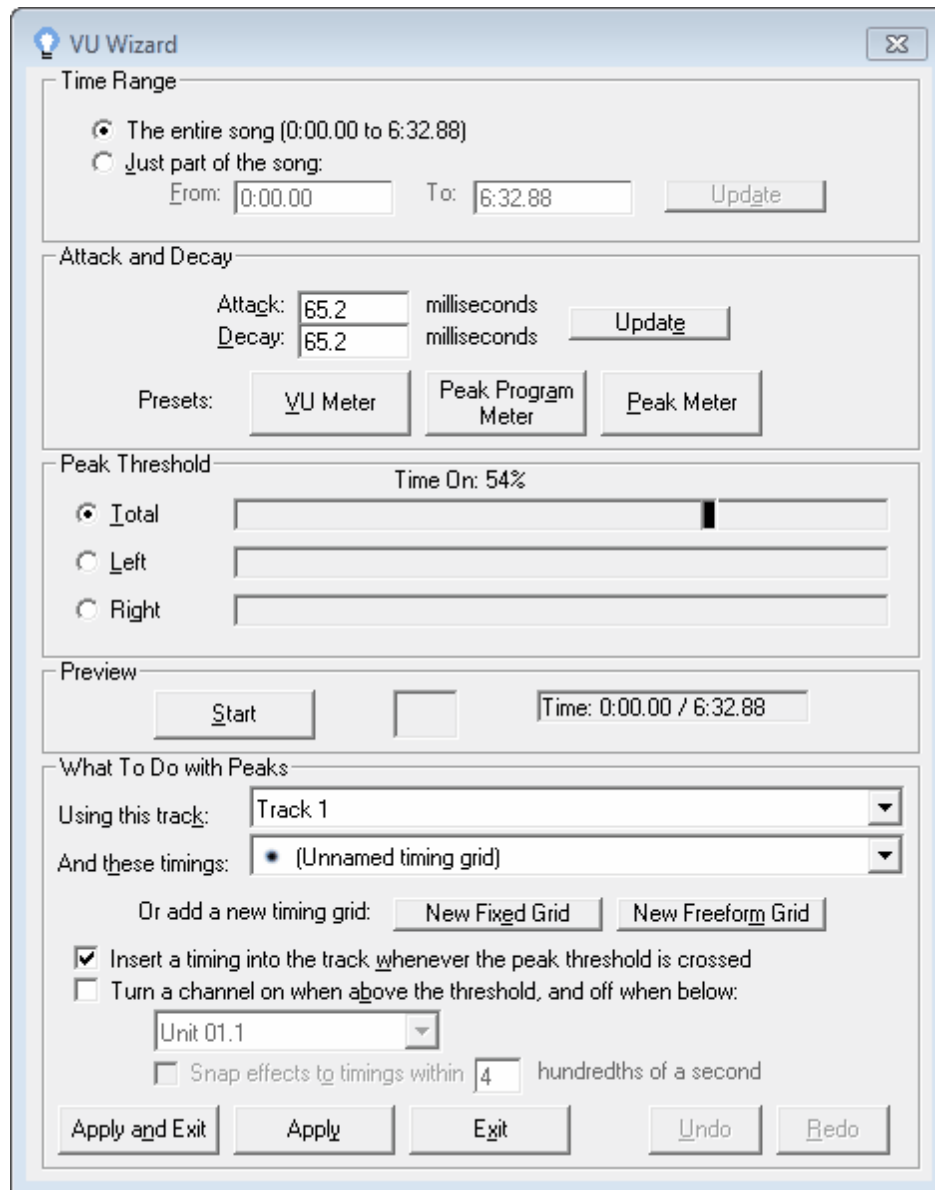

The VU Wizard

5.3.4.5 The Play Menu

The [Light-O-Rama Sequence Editor's](#) Play menu contains menu items enabling you to play open [sequences](#) and to affect the behavior of the Sequence Editor during play.

The following items are available on the Play menu:

- [Start This Sequence](#)
- [Start All Sequences](#)
- [Stop](#)
- [Lights Off Now](#)
- [Play Again](#)
- [Play Range](#)
 - [Full Sequence](#)
 - [Selection](#)

- [From Selection](#)
- [To Selection](#)
- [Visible Screen](#)
- [Loop at End](#)
- [Lights Off at End](#)
- [Control Lights](#)
- [Control Holiday Lights Designer](#)
- [Control Visualizer](#)
- [Move Grid with Play](#)
- [Vary Color of Channel Buttons](#)
- [Vary Color of Channel Button Fonts](#)
- [Highlight Current Event](#)
- [Highlight Current Time](#)
- [Speed](#)

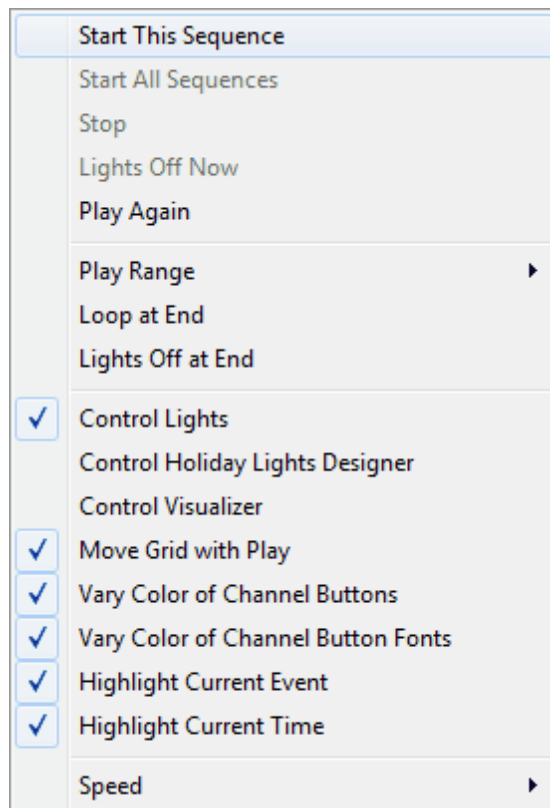

The Play menu

Start This Sequence

Selecting this item from the [Play menu](#) will cause the currently active [sequence](#) to start playing.

You can also start play by using the [Play button](#) on the [Standard toolbar](#).

Start All Sequences

Selecting this item from the [Play menu](#) will cause all open [sequences](#) to start playing. However, only one [musical sequence](#) can be playing at a time, so if you have more than one musical

sequence open, you will instead be told that you have to close all but one if you want to play all open sequences.

You can also start play by using the [Play button](#) on the [Standard toolbar](#).

Stop

Selecting this item from the [Play menu](#) will stop all playing [sequences](#).

You can also stop play by using the [Stop button](#) on the [Standard toolbar](#), or by simply waiting until the sequences naturally complete (unless "[Loop at End](#)" is enabled).

Lights Off Now

This item from the [Play menu](#) will turn off any lights that had previously been turned on during play. It is only available when "[Lights Off at End](#)" is turned off, and play is stopped, and lights had been sent commands since the last time it was used.

Play Again

Selecting this item from the [Play menu](#) will play the same thing that you last asked it to play. An example of how this could be useful:

If you are working on some particular section of a [sequence](#), you might set the [play range](#) to "[Selection](#)", and select the cells in the time range that you are currently interested in. When you start play, only that time range will be played. You might then notice something that you want to change about the [lighting effects](#) in that portion of the sequence. Doing so would change what time range was selected, so if you simply started play a second time, the portion of the sequence played would be different than your original selection.

You could re-select the original selection before starting play, but it would be easier to simply use "play again". It would play the same time range as you had originally selected, even though a different time range is now selected.

The [Play Again button](#) on the [Standard toolbar](#) also does this same thing.

Play Range

When playing a [sequence](#) in the [Sequence Editor](#), you can choose what portion of the sequence will be played by setting the play range in the [Play menu](#). The following play range modes are supported:

- [Full Sequence](#)
- [Selection](#)
- [From Selection](#)
- [To Selection](#)
- [Visible Screen](#)

Additionally, [freeform play mode](#) can be used to play any time range that you specify. Freeform play mode is not available on the Play Range menu; instead, please refer to [its help page](#) for details on how to use it.

Full Sequence

If you set the [Sequence Editor's play range](#) to "Full Sequence", then whenever it plays a [sequence](#), it will start at the beginning of the sequence, and stop at the end of the sequence.

Selection

If you set the [Sequence Editor's play range](#) to "Selection", then whenever it plays a [sequence](#), it will play only that time range of the sequence which is currently selected (i.e. the cells that are currently surrounded by a thick black border).

Note that all [channels](#) in the sequence will be played, even those outside of the current selection. Only the time range is set by this option.

From Selection

If you set the [Sequence Editor's play range](#) to "From Selection", then whenever it plays a [sequence](#), it will play the time range from the start of the current selection (i.e. the cells that are currently surrounded by a thick black border) to the end of the sequence.

Note that all [channels](#) in the sequence will be played, even those outside of the current selection. Only the time range is set by this option.

To Selection

If you set the [Sequence Editor's play range](#) to "To Selection", then whenever it plays a [sequence](#), it will play the time range from the start of the sequence to the end of the current selection (i.e. the cells that are currently surrounded by a thick black border).

Note that all [channels](#) in the sequence will be played, even those outside of the current selection. Only the time range is set by this option.

Visible Screen

If you set the [Sequence Editor's play range](#) to "Visible Screen", then whenever it plays a [sequence](#), it will play only that time range of the sequence that is currently displayed.

Note that all [channels](#) in the sequence will be played, even those currently above or below the visible portion of the sequence. Only the time range is set by this option.

Loop at End

If "Loop at End" is enabled in the [Play menu](#) of the [Sequence Editor](#), then whenever it plays a [sequence](#) and reaches the end of the [play range](#), instead of stopping, it will automatically loop back to the beginning of the play range and continue playing. The sequence can still be stopped manually, via "[Stop](#)" on the Play menu or the [Stop button](#) of the [Standard toolbar](#).

You can control whether or not "Loop at End" is enabled by default via "[Loop at the End of a Sequence by Default](#)" on the [Play Preferences dialog](#).

Note that this should not be confused with [loops](#) within a sequence.

Lights Off at End

If "Lights Off at End" is enabled in the [Play menu](#) of the [Sequence Editor](#), then whenever it plays a [sequence](#) and reaches the end of play, it will automatically turn off all lights in that sequence. If it is disabled, then any lights that happen to be on at the very end of the sequence will remain on.

Control Lights

If "Control Lights" is enabled in the [Play menu](#) of the [Sequence Editor](#), then whenever it plays a [sequence](#), the Sequence Editor will send [lighting effect](#) commands to your [controllers](#), causing your actual lights to be used.

Note that you will additionally need to have the [channels](#) in your sequence set up appropriately with information such as the unit IDs and circuit IDs of the controllers that are hooked up to your computer.

Control Holiday Lights Designer

If "Control Holiday Lights Designer" is enabled in the [Play menu](#) of the [Sequence Editor](#), then whenever it plays a sequence, the Sequence Editor will send lighting effect commands to [Holiday Lights Designer™](#), a third party add-on by [Holidaysoft®](#) which can be used to virtually place lights and decorations on images of your home or business.

Please also see the [Holiday Lights Designer Preferences dialog](#).

Control Visualizer

Enabling "Control Visualizer" is enabled in the [Play menu](#) of the [Sequence Editor](#) causes lighting effect commands to be sent to the [Light-O-Rama Visualizer](#).

Please also see the [Visualizer Preferences dialog](#).

Move Grid with Play

If "Move Grid with Play" is enabled in the [Play menu](#) of the [Sequence Editor](#), then whenever a [sequence](#) is played, the portion of the sequence's grid that is currently displayed will change as play progresses so that the current time is always displayed. Otherwise, the grid's display will simply remain static.

Vary Color of Channel Buttons

If "Vary Color of Channel Buttons" is enabled in the [Play menu](#) of the [Sequence Editor](#), then whenever it plays a [sequence](#), the color of a [channel button](#) will vary based upon the [lighting effect](#) taking place on that [channel](#) at that moment during the sequence.

You can control whether or not "Vary Color of Channel Buttons" is enabled by default via "[Vary the Color of Channel Buttons during Play by Default](#)" on the [Play Preferences dialog](#).

Vary Color of Channel Button Fonts

If "Vary Color of Channel Button Fonts" is enabled in the [Play menu](#) of the [Sequence Editor](#), then if "[Vary Color of Channel Buttons](#)" is also enabled, then whenever it plays a [sequence](#), the color of the text of a [channel button](#) will vary to try to give a readable contrast with the color of the channel button at that moment.

This setting has no effect if "Vary Color of Channel Buttons" is not enabled.

You can control whether or not "Vary Color of Channel Button Fonts" is enabled by default via "[Also vary their font colors](#)" on the [Play Preferences dialog](#).

Highlight Current Event

If "Highlight Current Event" is enabled in the [Play menu](#) of the [Sequence Editor](#), then whenever it plays a [sequence](#), the [timings](#) closest to the current time will be highlighted with thick black lines, moving as play progresses.

You can control whether or not "Highlight Current Event" is enabled by default via "[Highlight Current Event during Play by Default](#)" on the [Play Preferences dialog](#).

Highlight Current Time

If "Highlight Current Time" is enabled in the [Play menu](#) of the [Sequence Editor](#), then whenever it plays a [sequence](#), the current time will be highlighted with a dashed vertical line, moving as play progresses.

You can control whether or not "Highlight Current Time" is enabled by default via "[Highlight Current Time during Play by Default](#)" on the [Play Preferences dialog](#).

Speed

The Speed submenu of the [Play menu](#) can be used to instruct the [Sequence Editor](#) to play [sequences](#) at different speeds - quarter speed, half speed, normal speed, double speed, or quadruple speed.

Slower speeds may be useful, for example, when you are trying to precisely adjust the time at which a [lighting effect](#) takes place; faster speeds may be useful to get a quick overview of how the sequence looks.

5.3.4.6 The Window Menu

The Window menu of the [Light-O-Rama Sequence Editor](#) enables you to control how the windows for the open [sequences](#) are arranged on your screen. It also shows a list of the open sequences, which can be used to select which one is currently active.

The following menu items are available:

- [Tile Horizontally](#)
- [Tile Vertically](#)
- [Cascade](#)
- [Arrange Icons](#)

- [Minimize All Windows](#)
- [The Open Sequence List](#)

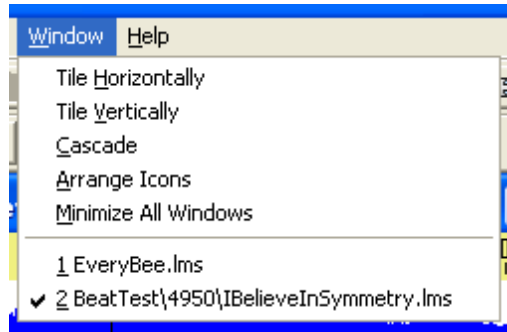

The Window menu

Tile Horizontally

When the [Sequence Editor](#) has multiple [sequences](#) open at once, this option from the [Window menu](#) will cause their windows to take up all available space, not overlapping with each other, and to be placed next to each other horizontally.

Tile Vertically

When the [Sequence Editor](#) has multiple [sequences](#) open at once, this option from the [Window menu](#) will cause their windows to take up all available space, not overlapping with each other, and to be placed above and below each other.

Cascade

When the [Sequence Editor](#) has multiple [sequences](#) open at once, this option from the [Window menu](#) will cause their windows to overlap with each other in an organized way.

Arrange Icons

If the [Sequence Editor](#) has any [sequences](#) open with their windows minimized, this option from the [Window menu](#) will order their icons neatly.

Minimize All Windows

Selecting this option from the [Window menu](#) of the [Sequence Editor](#) will cause the windows for all open [sequences](#) to become minimized.

The Open Sequence List

At the bottom of the [Window menu](#) of the [Sequence Editor](#) is a list of all of the [sequences](#) that are currently open. Clicking on one, or hitting the key of the number displayed next to it, will cause it to become the active sequence.

5.3.4.7 The Help Menu

The Help menu of the [Light-O-Rama Sequence Editor](#) brings up help and other information about Light-O-Rama.

The following options are available on the Help menu:

- [Contents](#)
- [Index](#)
- [Search](#)
- [Visit Light-O-Rama on the Web](#)
- [About the Light-O-Rama Editor](#)
- [Register \(or Upgrade\) Light-O-Rama](#)

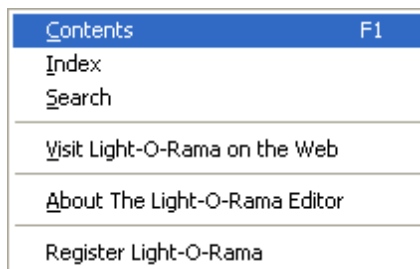

The Help menu

Contents

This option on the [Help menu](#) opens up the table of contents of the Light-O-Rama help files.

Index

This option on the [Help menu](#) opens up the index of the Light-O-Rama help files.

Search

This option on the [Help menu](#) opens up the search menu of the Light-O-Rama help files.

Visit Light-O-Rama on the Web

This option on the [Help menu](#) opens the [Light-O-Rama website](#) in your browser window.

About the Light-O-Rama Editor

This option on the [Help menu](#) brings up an "About" box displaying some information about the Light-O-Rama Sequence Editor.

Register (or Upgrade) Light-O-Rama

Use this item on the [Help menu](#) to [register your Light-O-Rama software](#), or to upgrade to a higher level license, unlocking various [features](#).

This item will show up as "Register Light-O-Rama" if you are using the unlicensed Demo version of the software, or "Upgrade" if you are using a license, but it is not the highest possible license level. If you are using the highest possible license level, this item will not be displayed at all.

5.3.5 Toolbars

The [Light-O-Rama Sequence Editor](#) has three toolbars: the [Standard toolbar](#), the [Tools toolbar](#), and the [Tracks and Timings toolbar](#).

The Standard toolbar has buttons for a variety of different functions, such as creating, opening, and saving [sequences](#), setting various display options, and playing sequences.

The Tools toolbar enables you to choose which [lighting effect tool](#) is currently in use, and set certain options regarding them.

The Tracks and Timings toolbar has dropdown boxes to allow you to quickly choose which track is displayed, and which timing grid it is displayed with, and it additionally has buttons with popup menus, with various track and timing grid-related menu items.

If desired, these toolbars can be hidden (and later unhidden) by using the "[Tool Bars](#)" item on the [View menu](#).



The Standard toolbar



The Tools toolbar

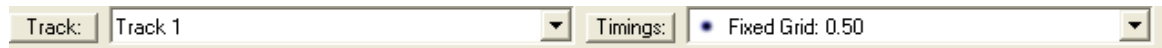

The Tracks and Timings Toolbar

5.3.5.1 The Standard Toolbar

The [Light-O-Rama Sequence Editor's](#) Standard toolbar contains buttons for several functions and options. From left to right, they are:

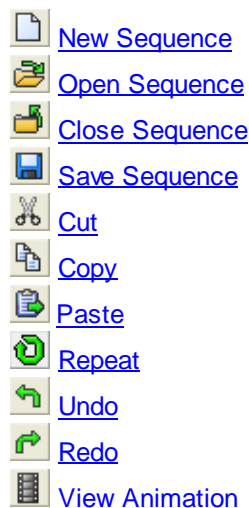

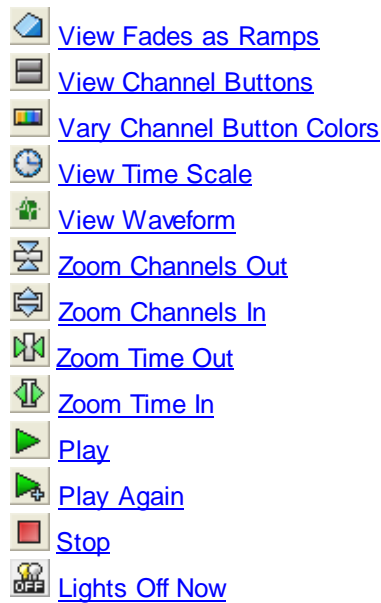

If desired, the toolbar can be hidden (or unhidden) via "[Tool Bars](#)" on the [View menu](#).



The Standard toolbar

New Sequence

This button on the [Standard toolbar](#) can be used to create a new [sequence](#). Clicking on it opens the [New and Open dialog](#), on its "[New Sequence](#)" tab.

Open Sequence

This button on the [Standard toolbar](#) can be used to open a [sequence](#). Clicking on it opens the [New and Open dialog](#), on whichever of its "[Existing Sequence](#)" tab or its "[Recent Sequence](#)" tab was most recently used.

Close Sequence

This button on the [Standard toolbar](#) can be used to close an open [sequence](#). Please see "[Close](#)" on the [File menu](#) for details.

Save Sequence

This button on the [Standard toolbar](#) can be used to save changes to an open [sequence](#). Please see "[Save](#)" on the [File menu](#) for details.

Cut

This button on the [Standard toolbar](#) can be used to cut [effects](#) from a [sequence](#). Please see "[Cut, Copy, Paste, and Paste Multiple](#)" on the [Edit menu](#) for details.

Copy

This button on the [Standard toolbar](#) can be used to copy [effects](#) from a [sequence](#). Please see "[Cut, Copy, Paste, and Paste Multiple](#)" on the [Edit menu](#) for details.

Paste

This button on the [Standard toolbar](#) can be used to paste [effects](#) into a [sequence](#). Please see "[Cut, Copy, Paste, and Paste Multiple](#)" on the [Edit menu](#) for details.

Repeat

The Repeat tool can be used to automatically place a copy of the selected area immediately after the selected area. For example, consider the following:

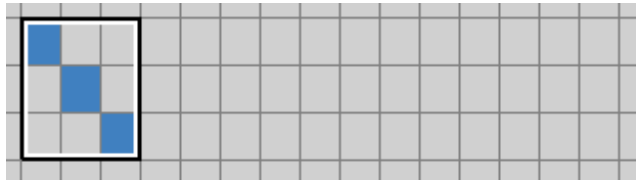

Before repeating

Then pressing the Repeat button will make the following:

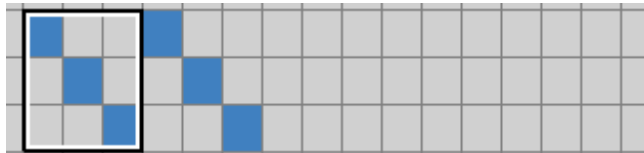

After repeating once

And you can repeat as many times as you like thereafter; for example, pressing Repeat three more times will make the following:



After repeating four times

The Repeat tool pays attention to your current "[Paste from Foreground](#)" setting. For example, before repeating:

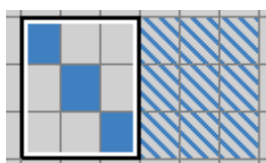

Before repeating

And after repeating, with "Paste from Foreground" enabled:

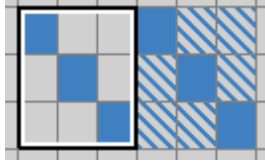

After repeating, with "Paste from Foreground" enabled

Undo

This button on the [Standard toolbar](#) can be used to undo changes to a [sequence](#). Please see "[Undo and Redo](#)" on the [Edit menu](#) for details.

Redo

This button on the [Standard toolbar](#) can be used to redo previously undone changes to a [sequence](#). Please see "[Undo and Redo](#)" on the [Edit menu](#) for details.

View Animation

This button on the [Standard toolbar](#) can be used to control whether the [animation](#) for a [sequence](#) is displayed. This can be set independently for different open sequences. Please see "[View Animation](#)" on the [View menu](#) for details.

View Fades as Ramps

This button on the [Standard toolbar](#) can be used to control whether fades are displayed as gradual changes in color or as ramps. Please see "[Fades](#)" on the [View menu](#) for details.

View Channel Buttons

This button on the [Standard toolbar](#) can be used to control whether the [channel buttons](#) for a [sequence](#) are displayed. This can be set independently for different open sequences. Please see "[View Channel Buttons](#)" on the [View menu](#) for details.

Vary Channel Button Colors

This button on the [Standard toolbar](#) can be used to control whether the [channel buttons](#) for a [sequence](#) will change color during play, based upon the [lighting effects](#) happening on those [channels](#). Please see "[Vary Color of Channel Buttons](#)" on the [Play menu](#) for details.

View Time Scale

This button on the [Standard toolbar](#) can be used to control whether a time scale is displayed at the top of an open [sequence](#). This can be set independently for different open sequences. Please see "[View Time Scale](#)" on the [View menu](#) for details.

View Waveform

This button on the [Standard toolbar](#) can be used to control whether the audio [waveform](#) is displayed at the top of an open [musical sequence](#). This can be set independently for different open musical sequences. Please see "[View Waveform](#)" on the [View menu](#) for details.

Zoom Channels Out

This button on the [Standard toolbar](#) can be used to zoom a [sequence's](#) rows (representing its [channels](#)) out, making them shorter. Please see "[Zoom Rows](#)" on the [View menu](#) for details.

Zoom Channels In

This button on the [Standard toolbar](#) can be used to zoom a [sequence's](#) rows (representing its [channels](#)) in, making them taller. Please see "[Zoom Rows](#)" on the [View menu](#) for details.

Zoom Time Out

This button on the [Standard toolbar](#) can be used to zoom a [sequence's](#) columns (representing the duration from one [timing](#) to the next) out, making them thinner. Please see "[Zoom Columns](#)" on the [View menu](#) for details.

Zoom Time In

This button on the [Standard toolbar](#) can be used to zoom a [sequence's](#) columns (representing the duration from one [timing](#) to the next) in, making them wider. Please see "[Zoom Columns](#)" on the [View menu](#) for details.

Play

This button on the [Standard toolbar](#) can be used to start play of an open [sequence](#) or sequences. If only a single sequence is open, it will be played; if more than one sequence is open, a popup menu will open, asking if you want to play all of the sequences or just the currently active sequence. Please see "[Start This Sequence](#)" and "[Start All Sequences](#)" on the [Play menu](#) for details.

Play Again

This button on the [Standard toolbar](#) can be used to start play in the same way as it was last started. Please see "[Play Again](#)" on the [Play menu](#) for details.

Stop

This button on the [Standard toolbar](#) can be used to stop a playing [sequence](#). Please see "[Stop](#)" on the [Play menu](#) for details.

Lights Off Now

This button on the [Standard toolbar](#) can be used to manually turn off lights. Please see "[Lights Off](#)"

[Now](#)" on the [Play menu](#) for details.

5.3.5.2 The Tools Toolbar

The Light-O-Rama [Sequence Editor's](#) Tools toolbar contains buttons which enable you to choose which [effect tool](#) is currently selected, as well as buttons to modify the behavior of those tools. From left to right, they are:

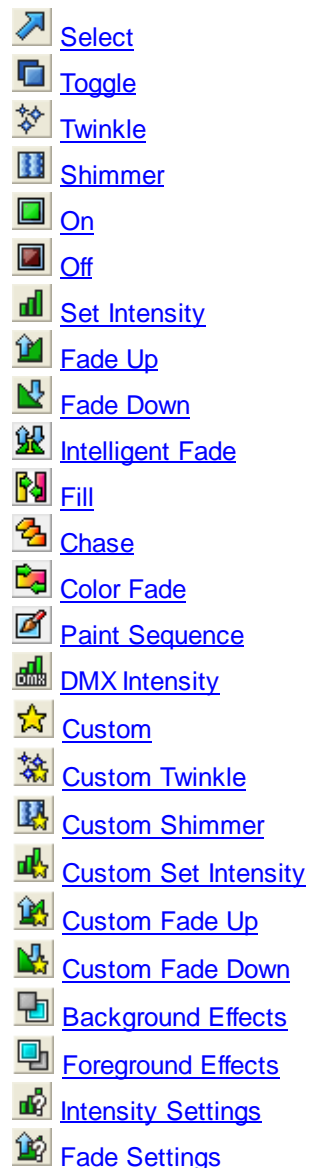

If desired, the Tools toolbar can be hidden (or unhidden) via "[Tool Bars](#)" on the [View menu](#).



The Tools toolbar

Select

This button on the [Tools toolbar](#) chooses the Select tool as the currently active [effect tool](#). It is equivalent to "[Select](#)" from the [Tools menu](#). Please refer to that help page for details.

Toggle

This button on the [Tools toolbar](#) chooses the Toggle tool as the currently active [effect tool](#). It is equivalent to "[Toggle](#)" from the [Tools menu](#). Please refer to that help page for details.

Twinkle

This button on the [Tools toolbar](#) chooses the Twinkle tool as the currently active [effect tool](#). It is equivalent to "[Twinkle](#)" from the [Tools menu](#). Please refer to that help page for details.

Shimmer

This button on the [Tools toolbar](#) chooses the Shimmer tool as the currently active [effect tool](#). It is equivalent to "[Shimmer](#)" from the [Tools menu](#). Please refer to that help page for details.

On

This button on the [Tools toolbar](#) chooses the On tool as the currently active [effect tool](#). It is equivalent to "[On](#)" from the [Tools menu](#). Please refer to that help page for details.

Off

This button on the [Tools toolbar](#) chooses the Off tool as the currently active [effect tool](#). It is equivalent to "[Off](#)" from the [Tools menu](#). Please refer to that help page for details.

Set Intensity

This button on the [Tools toolbar](#) chooses the Set Intensity tool as the currently active [effect tool](#). It is equivalent to "[Set Intensity](#)" from the [Tools menu](#). Please refer to that help page for details.

Fade Up

This button on the [Tools toolbar](#) chooses the Fade Up tool as the currently active [effect tool](#). It is equivalent to "[Fade Up](#)" from the [Tools menu](#). Please refer to that help page for details.

Fade Down

This button on the [Tools toolbar](#) chooses the Fade Down tool as the currently active [effect tool](#). It is equivalent to "[Fade Down](#)" from the [Tools menu](#). Please refer to that help page for details.

Intelligent Fade

This button on the [Tools toolbar](#) chooses the Intelligent Fade tool as the currently active [effect tool](#). It is equivalent to "[Intelligent Fade](#)" from the [Tools menu](#). Please refer to that help page for details.

Fill

This button on the [Tools toolbar](#) chooses the Fill tool as the currently active [effect tool](#). It is equivalent to "[Fill](#)" from the [Tools menu](#). Please refer to that help page for details.

Chase

This button on the [Tools toolbar](#) chooses the Chase tool as the currently active [effect tool](#). It is equivalent to "[Chase](#)" from the [Tools menu](#). Please refer to that help page for details.

Color Fade

This button on the [Tools toolbar](#) chooses the Color Fade tool as the currently active [effect tool](#). It is equivalent to "[Color Fade](#)" from the [Tools menu](#). Please refer to that help page for details.

Paint Sequence

This button on the [Tools toolbar](#) chooses the Paint Sequence tool as the currently active [effect tool](#). It is equivalent to "[Paint Sequence](#)" from the [Tools menu](#). Please refer to that help page for details.

DMX Intensity

This button on the [Tools toolbar](#) chooses the DMX Intensity tool as the currently active [effect tool](#). It is equivalent to "[DMX Intensity](#)" from the [Tools menu](#). Please refer to that help page for details.

Note: The DMX Intensity button is only present if [DMX editing](#) has been enabled.

Custom

This button on the [Tools toolbar](#) chooses the current [custom tool](#) as the currently active [effect tool](#). When this button is selected, the exact meaning of the current custom tool can be selected via the five buttons to its right - [Custom Twinkle](#), [Custom Shimmer](#), [Custom Set Intensity](#), [Custom Fade Up](#), and [Custom Fade Down](#).

For example, to use a tool that will shimmer the lights while fading them down, select this button, Custom Shimmer, and Custom Fade Down.

Custom Twinkle

When the [Custom button](#) is selected, this button on the [Tools toolbar](#) makes the current [custom tool](#) some sort of twinkle tool.

For example, to use a tool that will twinkle the lights while fading them down, select the Custom button, this button, and [Custom Fade Down](#).

Custom Shimmer

When the [Custom button](#) is selected, this button on the [Tools toolbar](#) makes the current [custom tool](#) some sort of shimmer tool.

For example, to use a tool that will shimmer the lights while fading them down, select the Custom button, this button, and [Custom Fade Down](#).

Custom Set Intensity

When the [Custom button](#) is selected, this button on the [Tools toolbar](#) makes the current [custom tool](#) some sort of set intensity tool.

For example, to use a tool that will twinkle the lights at some intensity other than full intensity, select the Custom button, [Custom Twinkle](#), and this button.

Custom Fade Up

When the [Custom button](#) is selected, this button on the [Tools toolbar](#) makes the current [custom tool](#) some sort of fade up tool.

For example, to use a tool that will twinkle the lights while fading them up, select the Custom button, [Custom Twinkle](#), and this button.

Custom Fade Down

When the [Custom button](#) is selected, this button on the [Tools toolbar](#) makes the current [custom tool](#) some sort of fade down tool.

For example, to use a tool that will twinkle the lights while fading them down, select the Custom button, [Custom Twinkle](#), and this button.

Background Effects

This button on the [Tools toolbar](#) can be used to enable [background effects mode](#). It is equivalent to "[Background Effects](#)" from the [Tools menu](#). Please refer to that help page for details.

Foreground Effects

This button on the [Tools toolbar](#) can be used to enable [foreground effects mode](#). It is equivalent to "[Foreground Effects](#)" from the [Tools menu](#). Please refer to that help page for details.

Intensity Settings

This button on the [Tools toolbar](#) can be used to open or close the Intensity Tool Settings dialog. It is equivalent to "[Intensity Tool Settings](#)" from the [Tools menu](#). Please refer to that help page for details.

Fade Settings

This button on the [Tools toolbar](#) can be used to open or close the Fade Tool Settings dialog. It is equivalent to "[Fade Tool Settings](#)" from the [Tools menu](#). Please refer to that help page for details.

5.3.5.3 The Track and Timings Toolbar

The Tracks and Timings toolbar consists of four controls, two related to [tracks](#) and two related to [timings](#) :

- [The track button](#)
- [The track dropdown](#)
- [The timings button](#)
- [The timings dropdown](#)



The Tracks and Timings toolbar

The Track Button

Clicking on the [Track and Timings toolbar's](#) track button brings up a popup menu with various [track](#)-related items:

- [Change Track Name](#)
- [Add new Track](#)
- [Duplicate Track](#)
- [Delete Track](#)

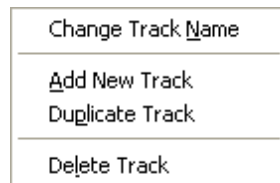

The track button's popup menu

Change Track Name

This menu item on the [track button's](#) popup menu can be used to change the name of the current [track](#). For details, please see the [Change Track Name](#) menu item on the [Edit menu](#).

Add New Track

This menu item on the [track button's](#) popup menu can be used to add a new [track](#) to the [sequence](#). For details, please see the [Add New Track](#) menu item on the [Edit menu](#).

Duplicate Track

This menu item on the [track button's](#) popup menu can be used to add a new [track](#) with all the same channels as the current track. For details, please see the [Duplicate Track](#) menu item on the [Edit menu](#).

Delete Track

This menu item on the [track button's](#) popup menu can be used to delete the current [track](#) from the [sequence](#). There must be at least one track in a sequence, so this menu item will be unavailable if there is only one track.

The Track Dropdown

The [Tracks and Timings toolbar's](#) track dropdown gives a list of the [tracks](#) in the [sequence](#). It displays the currently active track; selecting another track from the dropdown makes that track active, and updates the display to show that track if it is not already being shown.

The Timings Button

Clicking on the [Tracks and Timings toolbar's](#) timings button brings up a popup menu with various [timings](#)-related items:

- [Change Timing Grid Name](#)
- [Add New Fixed Grid](#)
- [Add New Freeform Grid](#)
- [Duplicate to New Freeform Grid](#)
- [Delete Timing Grid](#)



The timings button's popup menu

Change Timing Grid Name

This menu item on the [timings button's](#) popup menu can be used to change the name of the current [timing grid](#). The main purpose of giving a timing grid a name is to make it easier to distinguish timing grids when they are listed in places such as the [Tracks and Timings toolbar's timings dropdown](#).

Add New Fixed Grid

This menu item on the [timings button's](#) popup menu can be used to add a new [fixed timing grid](#) to the [sequence](#). After you select this item, you will be asked to specify the length of time between [timings](#) - for example, to make the timings a quarter second apart, enter "0.25".

Add New Freeform Grid

This menu item on the [timings button's](#) popup menu can be used to add a new [freeform timing grid](#) to the [sequence](#). After you select this item, you will be prompted to enter a name for the new timing grid.

Duplicate to New Freeform Grid

This menu item on the [timings button's](#) popup menu can be used to create a new [freeform timing](#)

[grid](#), initially populating it with the same [timings](#) as are in the current timing grid.

Note that this can be done regardless of whether the current timing grid is a freeform grid or a [fixed grid](#).

Delete Timing Grid

This menu item on the [timings button's](#) popup menu can be used to delete the current [timing grid](#) from the [sequence](#). Any [tracks](#) in the sequence that use this timing grid will automatically be switched to use some other timing grid from the sequence.

There must be at least one timing grid in a sequence, so this menu item will be unavailable if there is only one timing grid.

The Timings Dropdown

The [Tracks and Timings toolbar's](#) timings dropdown gives a list of the [timing grids](#) in the [sequence](#). It displays the timing grid currently in use on the active [track](#); selecting another timing grid from the dropdown changes the track to use that timing grid instead.

5.3.6 The Tools Panel

On the left-hand side of the [Light-O-Rama Sequence Editor](#) is a Tools panel, with three subpanels ("[Saved Tools](#)", "[Recent Tools](#)", and "[Clipboards](#)");

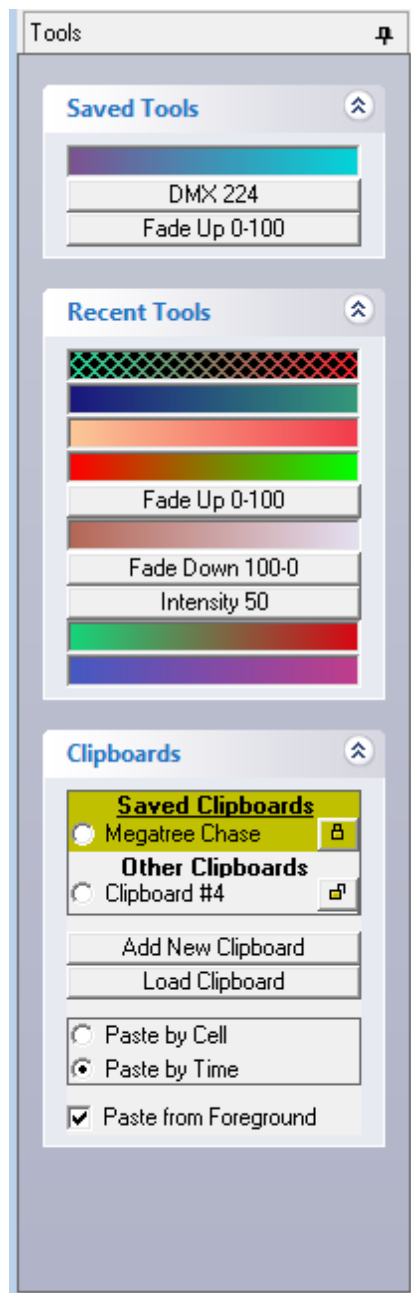

The Tools Panel

You can hide or show any individual subpanel by clicking on the arrows at its top right. For example, with the "Recent Tools" subpanel hidden:

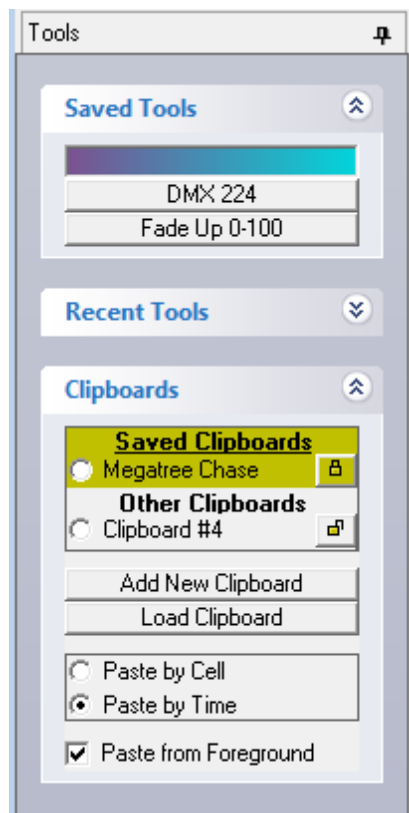

The Tools Panel, with the Recent Tools subpanel hidden

The Tools Panel can be partially hidden by clicking on the pin in its top right. This will cause the Tools Panel to collapse down to a narrow bar on the left, with a wrench icon on a tab:

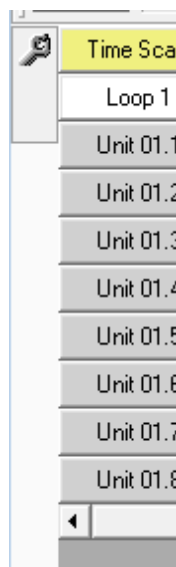

The Tools Panel, hidden

Moving your mouse over that tab will cause the panel to be shown again, at which time you can use its various items. After you are done with it, and move your mouse away from the panel, it will collapse back down to be hidden again. If you instead want it to remain open, you can click on its pin icon again.

You can also hide the Tools panel completely, so that not even the narrow bar with the wrench will be displayed, via "[Tools Panel](#)" on the [View menu](#). This can also be used to show the Tools panel again after having hidden it.

Whether the panel is visible or hidden, collapsed or open, and whether its individual subpanels are, is remembered in between runs of the Sequence Editor - that is, they will start up in the same states that they were in when you last used the Sequence Editor.

For details on the subpanels, please see their individual sections of the help file:

- [Saved Tools](#)
- [Recent Tools](#)
- [Clipboards](#)

5.3.6.1 Saved Tools

The Saved Tools list of the [Sequence Editor's](#) left-hand side [Tools Panel](#) is a list of [effect tools](#) that you have saved for future use. Once on the Saved Tools list, a tool will remain there, even when you use the Sequence Editor again in the future, unless and until you remove it from the list.

Clicking on a tool listed in the Saved Tools list makes that tool active.

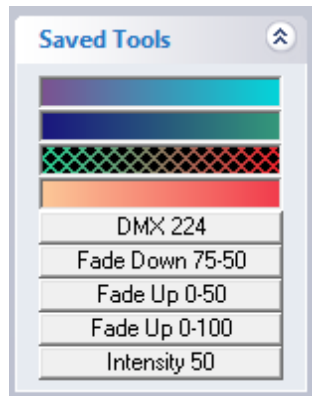

The Saved Tools list, with four saved color fades and five other saved tools

To put a tool on the Saved Tools list, right-click on its entry in the [Recent Tools](#) list, and select "Save Tool" from the popup menu that will open.

To remove a tool from the Saved Tools list, right-click on its entry in the Saved Tools list, and select "Remove Tool" from the popup menu that will open.

5.3.6.2 Recent Tools

The Recent Tools list of the [Sequence Editor's](#) left-hand side [Tools Panel](#) is a list of the [effect tools](#) that you have used most recently (with some exceptions, noted below). Clicking on a tool listed in the Saved Tools list makes that tool active.

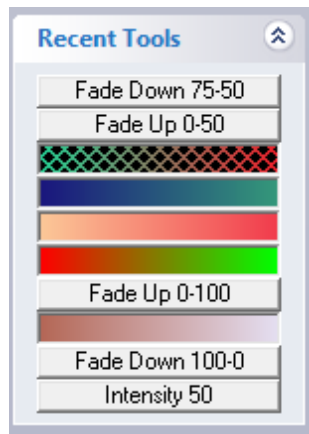

The Recent Tools list, with several color fades interspersed with several other tools

Not all tools that you use will be added to the Recent Tools list; a tool is only added to the list if you cannot get back to that tool in a single click via the Tools toolbar. For example, if you use the [Toggle tool](#) or the [Twinkle tool](#), they will not be added to the list, because you could get back to them in a single click, by clicking the [Toggle button](#) or the [Twinkle button](#), respectively. But if you use the [Fade Up tool](#) or a [custom tool](#) such as a twinkling intensity, it will be added, because it would take more than one mouse click to get back to it - a click to change to the "base" form of the tool itself, and one or more additional clicks to select the proper intensity values.

If you find a tool that you want to keep for future use, you can add it to the [Saved Tools](#) list by right-clicking on its entry in the Recent Tools list, and selecting "Save Tool" from the popup menu that will open.

5.3.6.3 Clipboards

Clipboards are used to copy (or cut) and paste lighting [effects](#) from some [channels](#) (or [RGB channels](#)) to others. In the [Light-O-Rama Sequence Editor](#), you can have multiple different clipboards at once, allowing you to keep several different copied sets of effects pastable simultaneously. You can also [save clipboards](#) so that their contents will still be available to you even when you use the Sequence Editor again in the future, [lock clipboards](#) so that they cannot be copied to (thus preventing accidental overwriting of their contents), and set various options on how pasting behaves ([paste by cell](#), [paste by time](#), [stretch to fit](#), [repeat to fit](#), and [paste from foreground](#)).

Clipboards can be managed through the Clipboards subpanel of the [left-hand Tools Panel](#):

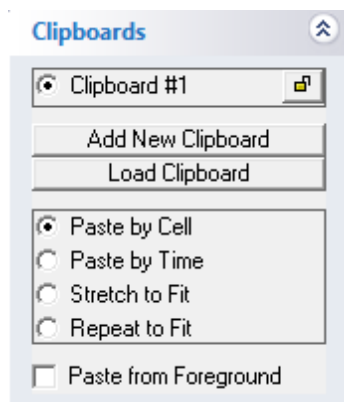

The Clipboards subpanel

Adding New Clipboards

By default, the [Sequence Editor](#) has a single [clipboard](#), as in the picture above. However, the "Add New Clipboard" button can be used to quickly create multiple clipboards:

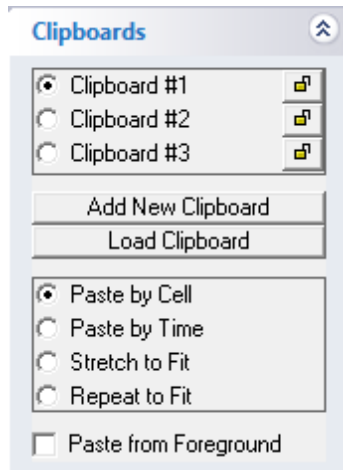

The Clipboards subpanel, with three clipboards

When multiple clipboards exist, you can select which one is currently in use simply by selecting the radio button to the left of its name.

Locking and Unlocking Clipboards

A [clipboard](#) can be locked or unlocked; a locked clipboard cannot be copied to (though it can still be pasted from). This is so as to prevent accidentally overwriting copied [effects](#) that you want to keep available. If you attempt to copy to a locked clipboard, a beep will occur to alert you that something is amiss.

You can lock an unlocked clipboard by pressing the "unlocked" button to the right of its name; the button will then change to "locked":

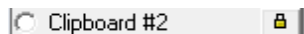

A locked clipboard

To unlock a locked clipboard, press the "locked" button, which will then change to "unlocked".

Saving Clipboards

[Clipboards](#) can be saved for later use, so that their contents will be available to you whenever you use the [Sequence Editor](#) in the future; any saved clipboards will be automatically loaded for you when you start up the Sequence Editor. To save a clipboard, right-click on the its name, which will open up a popup menu:

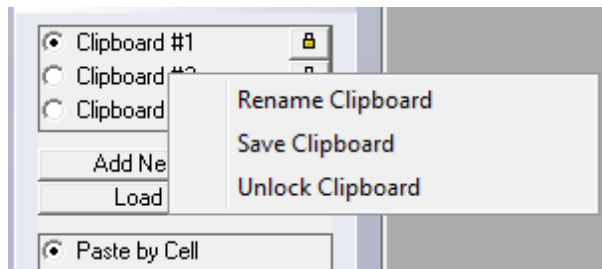

The clipboard popup menu

Select "Save Clipboard" from the popup menu; you will be prompted to give the clipboard a name (unless you have done so before), and the clipboard will then be moved to a different section in the top of the list of clipboards, in a different color, indicating that it is a saved clipboard:

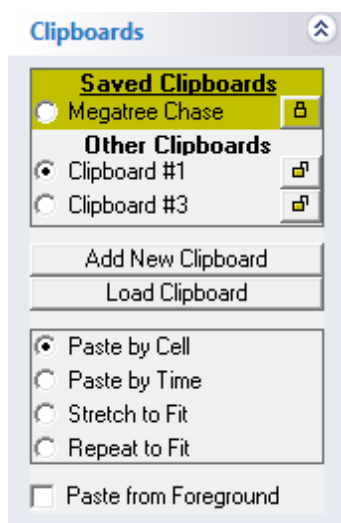

Clipboards, with a saved clipboard

A clipboard will be automatically [locked](#) upon being saved; you can, of course, unlock it if you wish. If you do unlock the clipboard, and make changes to it, the changes will automatically be resaved immediately, unless you turn off "[Automatically Resave](#)" in the [Clipboard Preferences menu](#), in which case they will not be saved until the Sequence Editor closes, or until you select "Save Clipboard" again.

Renaming Clipboards, and Other Uses of the Popup Menu

The clipboard popup menu (for a [clipboard](#) that has not been [saved](#)) also gives you the ability to rename the clipboard, remove the clipboard from the list, and to [lock or unlock](#) the clipboard:

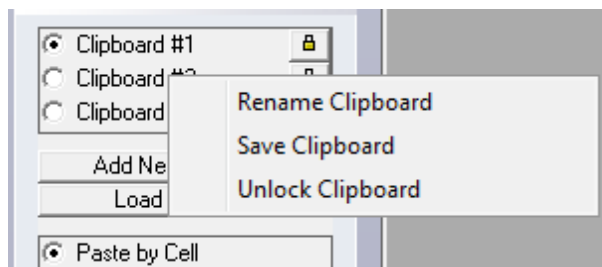

The clipboard popup menu

For a saved clipboard, the popup menu gives you the option to "unsave" the clipboard, thus moving it back into the "Other Clipboards" section (and making it so that the clipboard will not be automatically loaded the next time that you start the [Sequence Editor](#)), and to lock or unlock the clipboard.

Loading Clipboards

Any [saved clipboard](#) will be automatically loaded whenever you start the [Sequence Editor](#). However, if you had previously saved a clipboard, but had removed it from the saved list, you can later manually open it up again via the [Clipboards subpanel's](#) "Load Clipboard" button.

If you wish to reload the contents of a saved clipboard (for example, if a third party tool has changed the clipboard's save file outside of the Sequence Editor), this will automatically be done if "[Automatically Reload](#)" is checked on the [Clipboard Preferences menu](#). Otherwise, you can do so by selecting "Reload Clipboard" from the clipboard's popup menu.

Paste Mode

Towards the bottom of the [Clipboards subpanel](#) are controls that let you choose between four different paste modes: "[Paste by Cell](#)", "[Paste by Time](#)", "[Stretch to Fit](#)", and "[Repeat to Fit](#)". "Paste by cell" pastes the [effects](#) based upon the relative durations of the copied cells and the cells where they will be pasted; "paste by time" pastes them based only upon the duration of the copied effects; "stretch to fit" stretches the effects to fit into the area that you select; "repeat to fit" repeats as many copies of the effects as necessary to fit them into the area that you select.

Paste by Cell

Paste by Cell pastes [effects](#) based upon the relative durations of the copied cells and the cells where they will be pasted. For example, consider [timings](#) at 0 seconds, 1 second, and 2 seconds. Between 0 and 1 is a [fade up](#), and between 1 and 2 is a [fade down](#):

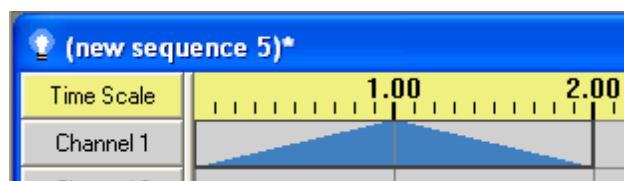

Events to be copied

These events will be copied, and pasted to the time starting at 5 seconds. There are timings at 5 seconds, 7 seconds, and 7.5 seconds:

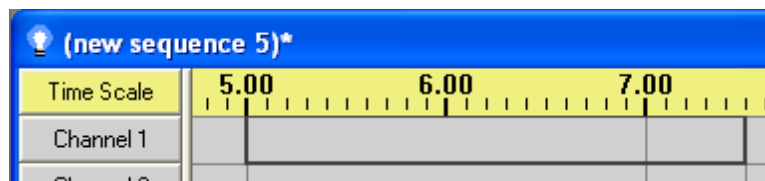

Where they will be pasted to

If "Paste by Cell" is selected, then there will be a fade up from 5 to 7, and a fade down from 7 to 7.5:

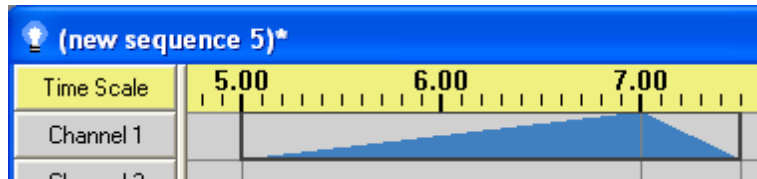

After pasting by cell

Paste by Time

Paste by Time pastes [effects](#) based upon their durations as they were copied. For example, consider [timings](#) at 0 seconds, 1 second, and 2 seconds. Between 0 and 1 is a [fade up](#), and between 1 and 2 is a [fade down](#):

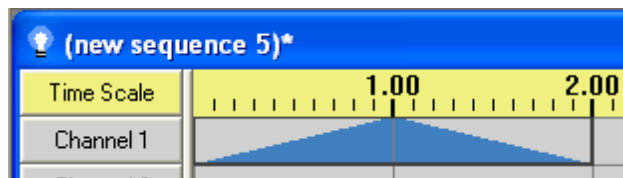

Events to be copied

These events will be copied, and pasted to the time starting at 5 seconds. There are timings at 5 seconds, 7 seconds, and 7.5 seconds:

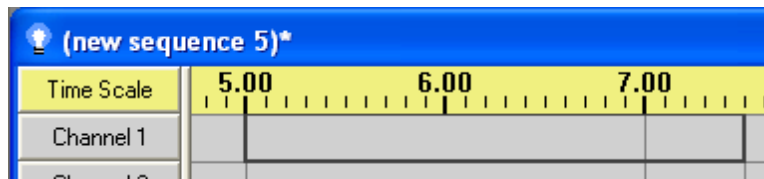

Where they will be pasted to

If "Paste by Time" is selected, then there will be a fade up from 5 to 6, and a fade down from 6 to 7. The timings at 7 and 7.5 are ignored; only the original lengths of the events are used:

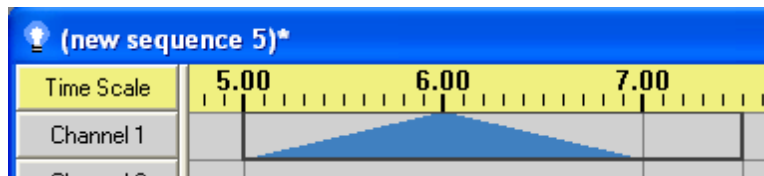

After pasting by time

Stretch to Fit

Stretch to Fit stretches (or compresses) effects to fit into the area that you have selected, without regards to any timings within that area. For example, consider [timings](#) at 0 seconds, 1 second, and 2 seconds. Between 0 and 1 is a [fade up](#), and between 1 and 2 is a [fade down](#):

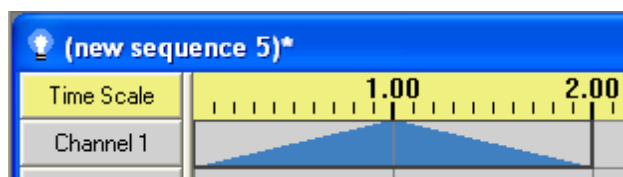

Events to be copied

These events will be copied, and pasted to the time starting at 5 seconds, with the area between 5 seconds and 7.5 seconds selected. There are timings at 5 seconds, 7 seconds, and 7.5 seconds:

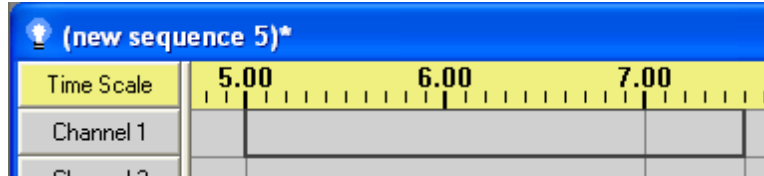

Where they will be pasted to

If "Stretch to Fit" is selected, then since the copied effects totalled two seconds in length, and since the area being pasted to is two and a half seconds in length, each effect will be stretched to 125% of its original length (since 2.5 seconds is 125% of 2 seconds). Therefore, there will be a fade up from 5 seconds to 6.25 seconds, and a fade down from 6.25 seconds to 7.5 seconds:

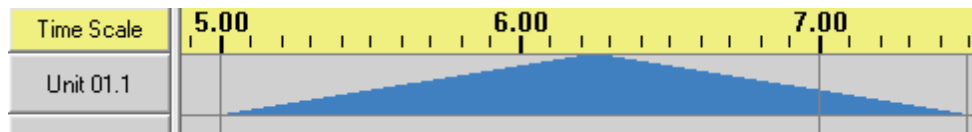

After stretching to fit

Repeat to Fit

Repeat to Fit repeats (or cuts off) effects to fit into the area that you have selected, without regards to any timings within that area. For example, consider [timings](#) at 0 seconds, 1 second, and 2 seconds. Between 0 and 1 is a [fade up](#), and between 1 and 2 is a [fade down](#):

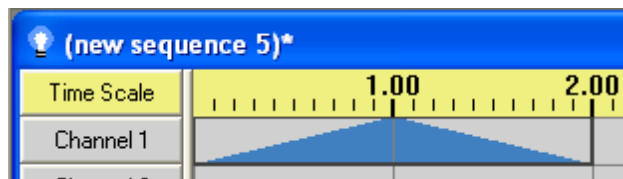

Events to be copied

These events will be copied, and pasted to the time starting at 5 seconds, with the area between 5 seconds and 7.5 seconds selected. There are timings at 5 seconds, 7 seconds, and 7.5 seconds:

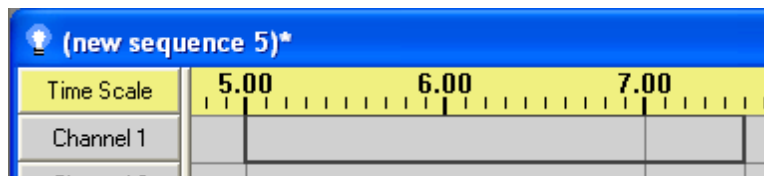

Where they will be pasted to

If "Repeat to Fit" is selected, then since the copied effects totalled two seconds in length, and since the area being pasted to is two and a half seconds in length, there will be one full copy of the copied effects for the first two seconds, followed by the first half second of a second copy of the effects. That is, there will be a fade up from 5 seconds to 6 seconds, a fade down from 6 seconds to 7 seconds, and the first half of a fade up from 7 seconds to 7.5 seconds:

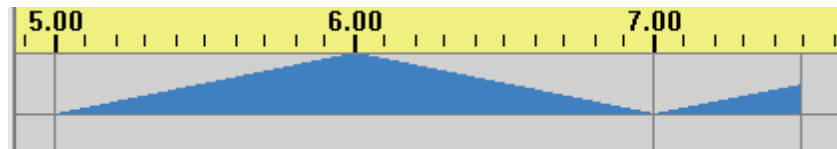

After repeating to fit

Paste from Foreground

At the bottom of the [Clipboards subpanel](#) is a checkbox labeled "Paste from Foreground". This checkbox controls whether or not copied "off" effects will overwrite existing effects when pasted. For example, consider the following portion of a [sequence](#), and imagine that the simple chase on the left will be copied and pasted on top of the [twinkling](#) on the right:

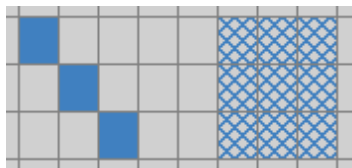

Before pasting the chase on top of the twinkling

If "Paste from Foreground" is turned off, then the entire copied area - including the off effects - will be pasted:

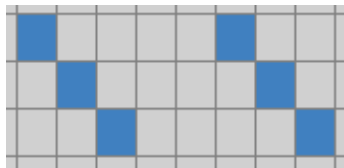

After pasting, without "Paste from Foreground"

But if "Paste from Foreground" is turned on, then the off effects are not pasted, leaving some of the cells twinkling:

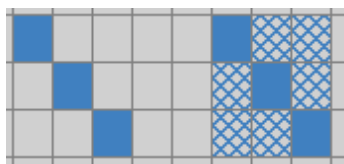

After pasting, with "Paste from Foreground"

"Paste from Foreground" also affects the behavior of the [Chase tool](#) and the Repeat tool, in similar fashion.

5.3.7 The Right-Click Context Menu

In the [Light-O-Rama Sequence Editor](#), [sequences](#) are represented using a grid. Rows in the grid represent [channels](#), and columns in the grid represent the duration between [timings](#). Cells in the grid are used to display what [lighting effects](#) are set in the sequence for that point in time on those channels.

Right-clicking on the grid brings up a popup menu. This menu contains several items which allow you to modify the currently selected cells, in a variety of ways. For example, you can insert lighting effects, cut, copy, and paste (both effects and timings), and delete or resize timings.

The following items are available on this right-click context menu:

- [Fade Down](#)
- [Fade Up](#)
- [On](#)
- [Off](#)
- [Set Intensity](#)
- [Shimmer](#)
- [Toggle](#)
- [Twinkle](#)
- [Fill](#)
- [Background Effects](#)
- [Foreground Effects](#)
- [Select Row\(s\)](#)
- [Select Column\(s\)](#)
- [Cut](#)
- [Copy](#)
- [Paste](#)
- [Paste Multiple](#)
- [Copy Timing](#)
- [Paste Timing at...](#)
- [Paste Timing at \(centisecond\)](#)
- [Paste Timing Multiple](#)
- [Insert Timing at...](#)
- [Insert Timing at \(centisecond\)](#)
- [Insert Multiple Timings](#)
- [Subdivide Timings](#)
- [Delete Timing at \(centisecond\)](#)
- [Delete Selected Timings](#)
- [Resize Timings to...](#)
- [Resize Timings to Equal Times](#)
- [Clear Freeform Play Range](#)

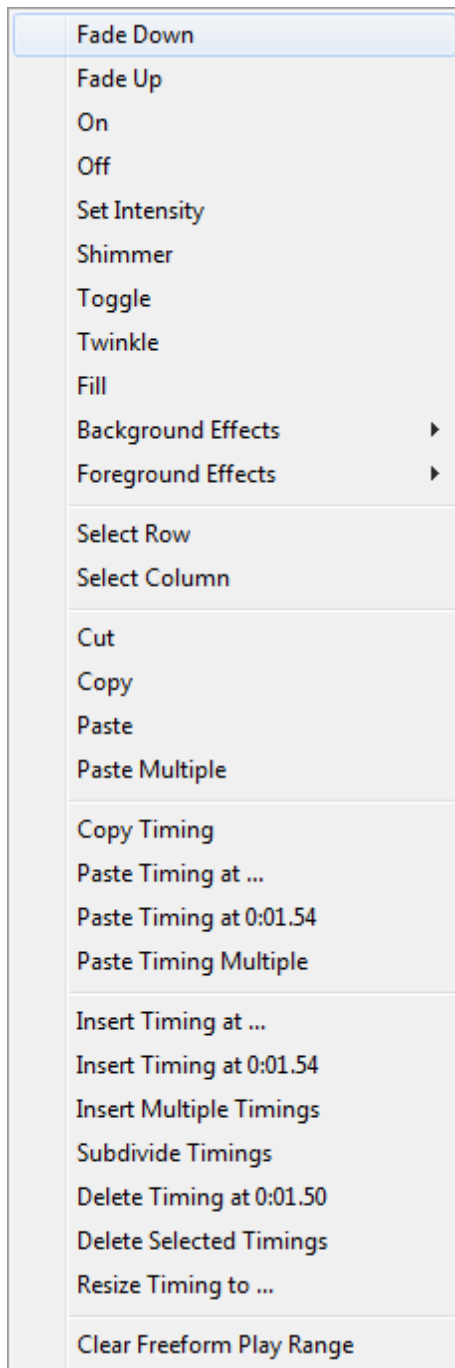

The right-click context menu

Fade Down

This item on the [right-click context menu](#) will insert a [fade down effect](#) into the currently selected cell or cells.

Fade Up

This item on the [right-click context menu](#) will insert a [fade up effect](#) into the currently selected cell or

cells.

On

This item on the [right-click context menu](#) will insert an [on effect](#) into the currently selected cell or cells.

Off

This item on the [right-click context menu](#) will insert an [off effect](#) into the currently selected cell or cells.

Set Intensity

This item on the [right-click context menu](#) will insert a [set intensity effect](#) into the currently selected cell or cells.

Shimmer

This item on the [right-click context menu](#) will insert a [shimmer effect](#) into the currently selected cell or cells.

Toggle

This item on the [right-click context menu](#) will toggle the [effects](#) in the currently selected cell or cells between [on and off](#). Any that had been off will be turned on; all others will be turned off (note that this includes not just those that had been on, but also, for example, those that had been [shimmers](#) or [fades](#)).

Twinkle

This item on the [right-click context menu](#) will insert a [twinkle effect](#) into the currently selected cell or cells.

Fill

This item on the [right-click context menu](#) will apply a [fill](#) to every [off event](#) in the currently selected cell or cells.

Background Effects

This submenu of the [right-click context menu](#) can be used to insert various [effects](#) (such as [fades](#) and [shimmers](#)) into the currently selected cell or cells, using [background effects mode](#).

Note that this does not turn on background effects mode permanently; it merely enables it for this one insertion.

Foreground Effects

This submenu of the [right-click context menu](#) can be used to insert various [effects](#) (such as [fades](#)

and [shimmers](#)) into the currently selected cell or cells, using [foreground effects mode](#).

Note that this does not turn on foreground effects mode permanently; it merely enables it for this one insertion.

Select Row(s)

This item on the [right-click context menu](#) changes the selection so that any rows that are in the selection become completely selected. That is, the selection will stay on the same row or rows, but from time zero to the end of the [track](#).

Select Column(s)

This item on the [right-click context](#) menu changes the selection so that any column or columns that are in the selection become completely selected. That is, the selection will stay on the same time range, but from the first [channel](#) to the last.

Cut

This item on the [right-click context menu](#) will cut the [effects](#) from the currently selected cell or cells. Please see "[Cut, Copy, Paste, and Paste Multiple](#)" on the [Edit menu](#) for details.

Copy

This item on the [right-click context menu](#) will copy the [effects](#) from the currently selected cell or cells. Please see "[Cut, Copy, Paste, and Paste Multiple](#)" on the [Edit menu](#) for details.

Paste

This item on the [right-click context menu](#) will paste [effects](#) into the [sequence](#), starting at the start of the currently selected cell or cells. Please see "[Cut, Copy, Paste, and Paste Multiple](#)" on the [Edit menu](#) for details.

Paste Multiple

This item on the [right-click context menu](#) opens a dialog that can be used to paste several copies of [effects](#) into the [sequence](#), starting from the currently selected cell or cells. For example, you can choose to paste the effects three times in a row horizontally, and two times in a row vertically. Please see "[Cut, Copy, Paste, and Paste Multiple](#)" on the [Edit menu](#) for details.

Copy Timing

This item on the [right-click context menu](#) will copy the [timings](#) from the currently selected cell or cells. Please see "[Copy and Paste Timings](#)" on the [Edit menu](#) for details.

Paste Timing at ...

This item on the [right-click context menu](#) can be used to paste copied [timings](#) into the [sequence](#). It opens a dialog asking you for the time that you want to paste the timings to (defaulting to the time that you right-clicked when opening the context menu). Please see "[Copy and Paste Timings](#)" on

the [Edit menu](#) for details, and [Time Format](#) for details on how to enter times.

Paste Timing at (*centisecond*)

This item on the [right-click context menu](#) can be used to paste copied [timings](#) into the sequence, starting at the time that you right-clicked when opening the context menu. Please see "[Copy and Paste Timings](#)" on the [Edit menu](#) for details.

Paste Timing Multiple

This item on the [right-click context menu](#) can be used to paste copied [timings](#) into the sequence, multiple times in a row. Please see "[Copy and Paste Timings](#)" on the [Edit menu](#) for details.

Insert Timing at ...

This item on the [right-click context menu](#) can be used to insert a [timing](#) into the [sequence](#). It opens a dialog asking you for the time that you want to insert a timing at (defaulting to the time that you right-clicked when opening the context menu). Please see [Time Format](#) for details on how to enter times.

Insert Timing at (*centisecond*)

This item on the [right-click context menu](#) can be used to insert a [timing](#) into the [sequence](#) at the time that you right-clicked when opening the context menu.

Insert Multiple Timings

This item on the [right-click context menu](#) can be used to insert multiple evenly-spaced [timings](#) into the selected cell or cells, based on the length of the entire selection. See "[Insert Multiple Timings](#)" on the [Timings submenu](#) of the [Edit menu](#) for details.

Also see "[Subdivide Timings](#)" for similar, but different, functionality.

Subdivide Timings

This item on the [right-click context menu](#) can be used to insert multiple evenly-spaced [timings](#) into each selected cell, based on the length of the cell. See "[Subdivide Timings](#)" on the [Timings submenu](#) of the [Edit menu](#) for details.

Also see "[Insert Multiple Timings](#)" for similar, but different, functionality.

Delete Timing at (*centisecond*)

This item on the [right-click context menu](#) can be used to delete the [timing](#) closest on the left to the time that you right-clicked when opening the context menu.

Delete Selected Timings

This item on the [right-click context menu](#) can be used to delete the [timings](#) inside the currently selected cells. Note that the two timings on the edges of the currently selected cells are not

deleted.

Resize Timings to ...

This item on the [right-click context menu](#) can be used to change the duration of time between the selected [timings](#). It will not allow any of the timings to be pushed beyond the next timing in the sequence. Please see [Time Format](#) for details on how to enter times.

Note that the length of the sequence will not be affected, nor the positions of the timings past the selected range. So, if you choose to resize some timings such that their total length decreases, this will cause the cell just past them to increase in size (since the last selected timing is moved earlier, while the next timing remains the same).

Resize Timings to Equal Times

This item on the [right-click context menu](#) can be used to change the duration of time between the selected [timings](#) so that all such durations are equal (or as close to equal as possible). For example, if you select two cells with durations of 0.2 seconds and 0.8 seconds, and use "Resize Timings to Equal Times", they will both change to 0.5 seconds.

Clear Freeform Play Range

If a [track](#) has a [freeform play range](#) selected, this item on the [right-click context menu](#) can be used to remove it.

5.3.8 Channel and RGB Channel Buttons

In the [Light-O-Rama Sequence Editor](#), [sequences](#) are represented using a grid. Rows in the grid represent [channels](#) and [RGB channels](#), and columns in the grid represent the duration between [timings](#). Cells in the grid are used to display what [lighting effects](#) are set in the sequence for that point in time on those channels and RGB channels.

In each row, to the left of the grid, there is a button associated with the channel or RGB channel for that row. The button is labeled with the name of the channel or RGB channel:

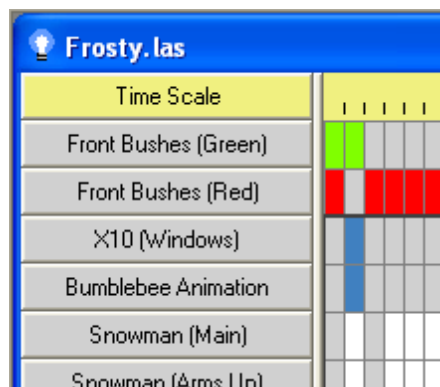

Some channel buttons (on the left)

Buttons for regular channels are shown in grey, as in the above picture. Those for RGB channels are shown in black, as in the first row of the following:

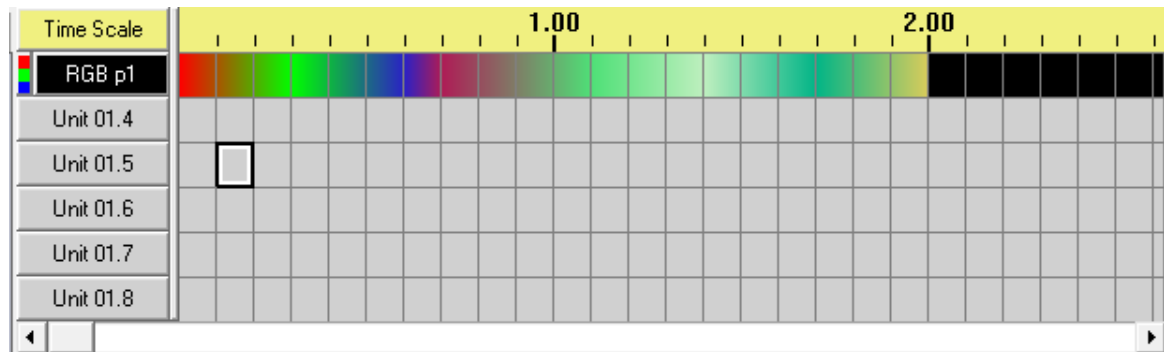

A sequence with an RGB channel followed by several normal channels

Left-clicking on such a button brings up the [Channel Settings dialog](#) if for a channel, and the [RGB Channel Settings dialog](#) if for an RGB channel, from which you can modify various settings such as a channel's name, color, [unit ID](#), and [circuit ID](#).

Right-clicking brings up the [channel button's popup menu](#), giving access to various channel-related functionality.

Left-clicking on the small button to the left of an RGB channel's button (with the red, green, and blue stripes) expands the view so that the constituent channels of that RGB channel can be seen (and clicking it again collapses the view by hiding them):

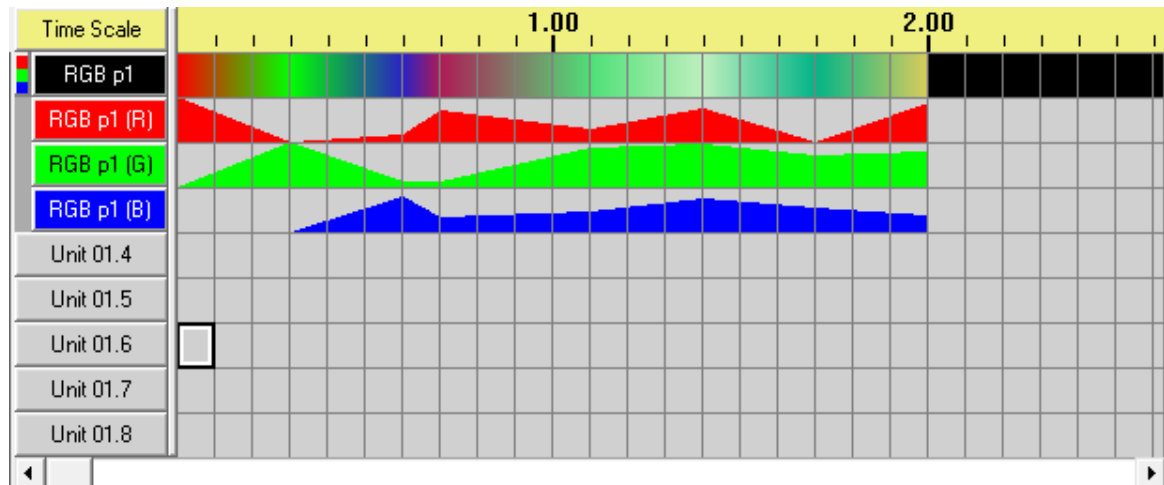

A sequence with an RGB channel followed by several normal channels, with the RGB channel's constituent channels displayed

Channels or RGB channels can be moved up or down in a sequence by clicking and dragging their buttons.

Between the channel/RGB channel buttons and the grid is a thick grey vertical bar. Dragging the bar left or right changes the width of the channel/ RGB channel buttons; clicking on it (without dragging) hides them, and clicking it again unhides them. This latter can also be done via "[Channel Buttons](#)" on the [View menu](#).

During play, the color of a channel or RGB channel button will vary along with the [lighting effects](#) happening on that channel or RGB channel. For example, during a [fade](#), the button will gradually change in color, and during a [twinkle](#), the button will blink between its usual light grey and the channel's

color. If you do not wish to see this, you can turn this behavior off permanently via "[Vary the color of channel buttons during play by default](#)" on the [Play Preferences dialog](#), or temporarily via either "[Vary Color of Channel Buttons](#)" on the [Play menu](#) or the [Vary Channel Button Colors button](#) of the [Standard toolbar](#).

The color of the text on the button can also vary during play, to try to give a readable contrast with the color of the button itself. However, some users have found this distracting, and so you can control whether this happens or not permanently via the "[Also vary their font colors](#)" on the [Play Preferences dialog](#), or temporarily via the "[Vary Color of Channel Button Fonts](#)" item on the [Play menu](#).

When not playing, the color of a button can behave in three different ways, controlled from the [Channel Button Colors submenu](#) of the [View menu](#): They can either all show the same grey (or black for RGB channels), or their individual full colors, or their colors at the time of the start of the current selection.

5.3.8.1 Channel Settings

The [Sequence Editor's](#) Channel Settings dialog allows you to set various properties of a [channel](#) in your [sequence](#), such as its name, color, unit ID and circuit ID.

You can access the Channel Settings dialog by clicking on the [channel's button](#), or right-clicking and selecting "[Change Channel Settings](#)" from the [popup menu](#).

Not all settings are available for all channel types; for example, [X10 controllers](#) do not use circuit IDs, and only channels representing [subsequences](#) can specify the name of a sequence file. The controls for unavailable settings will be greyed out.

The [Channel Configuration screen](#) allows you to do the same sort of things as the Channel Settings dialog, but can be used on all of the channels in your sequence at the same time.

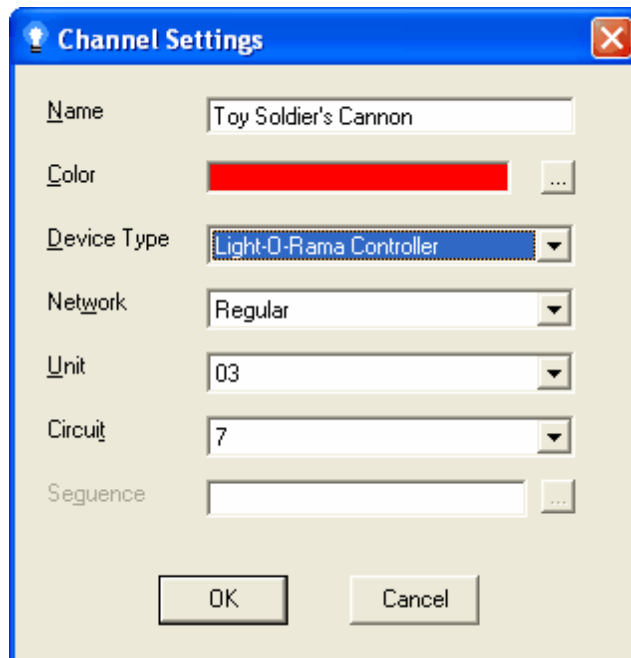

The Channel Settings dialog

5.3.8.2 RGB Channel Settings

The [Sequence Editor](#)'s RGB Channel Settings dialog allows you to set various properties of an [RGB channel](#) in your [sequence](#), such as its name and the [unit](#) and [circuit IDs](#) of its constituent [channels](#).

You can access the RGB Channel Settings dialog by clicking on the [RGB channel's button](#), or right-clicking and selecting "[Change RGB Channel Settings](#)" from the [popup menu](#).

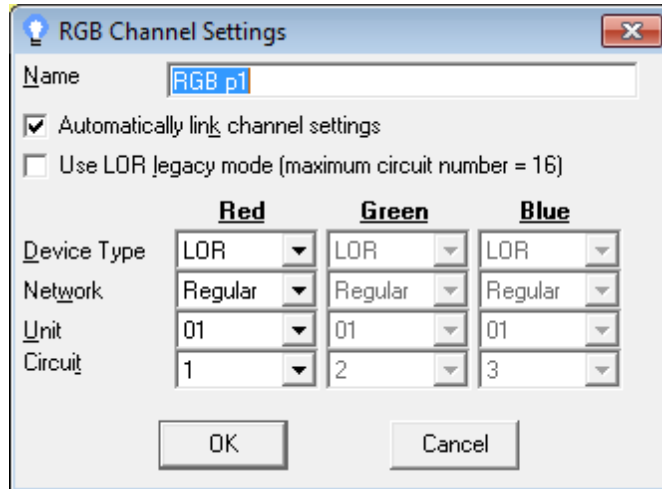

The RGB Channel Settings dialog

In the above picture, notice that the settings for the green and blue channels are greyed out, so that their settings cannot be modified (directly). This is because the "Automatically link channel settings" checkbox is checked. When it is checked, any change to the red channel's settings will be automatically reflected in the green and blue channels. For example, setting the red channel's unit ID to 02 will cause both the green and blue channels to automatically change to unit ID 02, and setting the red channel's circuit ID to 4 will cause the green channel's circuit ID to become 5, and the blue's to become 6.

To modify the green and blue channels' settings independently of those of the red channel, uncheck the "Automatically link channel settings" checkbox.

The "Use LOR legacy mode" checkbox, if checked, will limit the available circuit IDs from 1 to 16 (as opposed to the standard 1 to 512). This is to support older [controllers](#), which might each have several different unit IDs, each of which have circuit IDs from 1 to 16, instead of having a single unit ID with many circuit IDs.

5.3.8.3 Channel and RGB Channel Buttons' Popup Menus

In the [Sequence Editor](#), right-clicking on a [channel](#) or [RGB channel button](#) brings up a popup menu of items regarding that [channel](#) or [RGB channel](#). These include:

- [Change Name](#)
- [Change Color](#)
- [Change Channel Settings / Change RGB Channel Settings](#)
- [Insert Device](#)
 - [Insert Device Above](#)
 - [Insert Device Below](#)
- [Insert Channels](#)

- [Insert Channel Above](#)
- [Insert Channel Below](#)
- [Insert Multiple Channels Above](#)
- [Insert Multiple Channels Below](#)
- [Insert RGB Channels](#)
 - [Insert RGB Channel Above](#)
 - [Insert RGB Channel Below](#)
 - [Insert Multiple RGB Channels Above](#)
 - [Insert Multiple RGB Channels Below](#)
- [Convert to RGB Channel](#)
- [Convert to Group](#)
- [Duplicate Children to New Group](#)
- [Degroup](#)
- [Delete Channel / Delete RGB Channel](#)
- [Remove Channel from Track / Remove RGB Channel from Track](#)
- [Copy to Other Track](#)
 - [Copy to New Track](#)
 - [Copy to Track Number...](#)
- [Move](#)
 - [Move Up](#)
 - [Move Down](#)
 - [Move to New Track](#)
 - [Move to Track Number...](#)

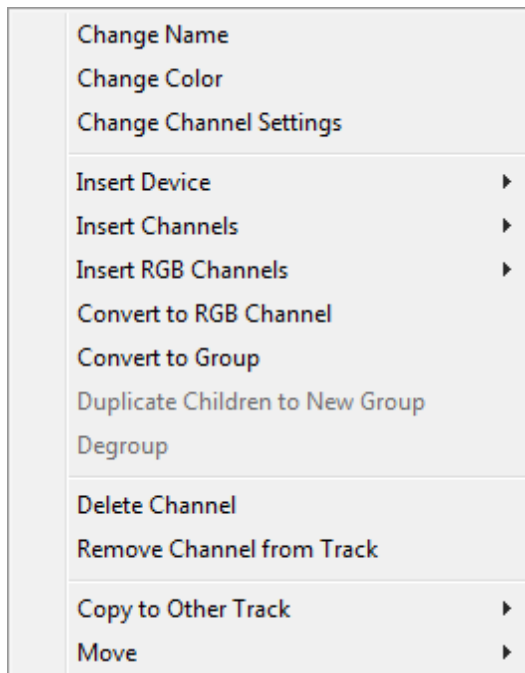

The channel button popup menu

Change Name

This option from the [channel/RGB channel button popup menu](#) can be used to change the name of the [channel](#) or [RGB channel](#). The name will be displayed in various places, including on the [channel or RGB channel's button](#).

Change Color

This option from the [channel button popup menu](#) can be used to change the color assigned to the [channel](#) (it is unavailable for [RGB channels](#)). Note that this has no effect on your actual lights, and that it is not necessary to set the color of the channel to match the color of the actual lights hooked up to the channel. However, doing so may be convenient. For example, the [Sequence Editor](#) will use the assigned color to display [lighting effects](#) in the [sequence's](#) grid.

Change Channel Settings / Change RGB Channel Settings

This option from the [channel/RGB channel button popup menu](#) opens the [Channel Settings dialog](#) or the [RGB Channel Settings dialog](#), which can be used to modify various properties of the [channel](#) or [RGB channel](#), such as a channel's name, color, [unit ID](#) and [circuit ID](#).

Insert Device

This submenu of the [channel/RGB channel button popup menu](#) can be used to insert [channels](#) and/or [RGB channels](#) representing a particular device (such as a Cosmic Color Device or an LOR/CTB device) above or below the selected channel or RGB channel.

- [Insert Device Above](#)
- [Insert Device Below](#)

Insert Device Above

This option from the [channel/RGB channel button popup menu](#) opens up the [Insert Device dialog](#), allowing you to specify settings of a new device (such as a Cosmic Color Device or an LOR/CTB device) to be inserted into the [sequence](#) above the selected [channel](#) or [RGB channel](#).

Insert Device Below

This option from the [channel/RGB channel button popup menu](#) opens up the [Insert Device dialog](#), allowing you to specify settings of a new device (such as a Cosmic Color Device or an LOR/CTB device) to be inserted into the [sequence](#) below the selected [channel](#) or [RGB channel](#).

Insert Channels

This submenu of the [channel/RGB channel button popup menu](#) can be used to insert a [channel](#), or multiple channels, above or below the selected channel or [RGB channel](#).

- [Insert Channel Above](#)
- [Insert Channel Below](#)
- [Insert Multiple Channels Above](#)
- [Insert Multiple Channels Below](#)

Insert Channel Above

This option from the [channel/RGB channel button popup menu](#) creates a new [channel](#) and inserts it into the [sequence](#) above the selected channel or [RGB channel](#).

Insert Channel Below

This option from the [channel/RGB channel button popup menu](#) creates a new [channel](#) and inserts it into the [sequence](#) below the selected channel or [RGB channel](#).

Insert Multiple Channels Above

This option from the [channel/RGB channel button popup menu](#) can be used to create multiple new [channels](#) at once, and insert them into the [sequence](#) above the selected channel or [RGB channel](#). You will be prompted for how many channels you want to create.

Insert Multiple Channels Below

This option from the [channel/RGB channel button popup menu](#) can be used to create multiple new [channels](#) at once, and insert them into the [sequence](#) below the selected channel or [RGB channel](#). You will be prompted for how many channels you want to create.

Insert RGB Channels

This submenu of the [channel/RGB channel button popup menu](#) can be used to insert an [RGB channel](#), or multiple RGB channels, above or below the selected [channel](#) or RGB channel.

- [Insert RGB Channel Above](#)
- [Insert RGB Channel Below](#)
- [Insert Multiple RGB Channels Above](#)
- [Insert Multiple RGB Channels Below](#)

Insert RGB Channel Above

This option from the [channel/RGB channel button popup menu](#) creates a new [RGB channel](#) and inserts it into the [sequence](#) above the selected [channel](#) or RGB channel.

Insert Channel Below

This option from the [channel/RGB channel button popup menu](#) creates a new [RGB channel](#) and inserts it into the [sequence](#) below the selected [channel](#) or RGB channel.

Insert Multiple Channels Above

This option from the [channel/RGB channel button popup menu](#) can be used to create multiple new [RGB channels](#) at once, and insert them into the [sequence](#) above the selected [channel](#) or RGB channel. You will be prompted for how many RGB channels you want to create.

Insert Multiple Channels Below

This option from the [channel/RGB channel button popup menu](#) can be used to create multiple new [RGB channels](#) at once, and insert them into the [sequence](#) below the selected [channel](#) or RGB channel. You will be prompted for how many RGB channels you want to create.

Convert to RGB Channel

This option from the [channel button popup menu](#) opens the [Convert to RGB Channel dialog](#), which allows you to convert existing [channels](#) into [RGB channels](#). It is not available from the popup menus for RGB channel buttons.

Convert to Group

This option from the [channel button popup menu](#) opens the [Convert to Channel Group dialog](#), which allows you to group existing [channels](#) (and [RGB channels](#), et cetera) into a new [channel group](#).

Duplicate Children to New Group

This option from the [channel button popup menu](#) can be used to create an entirely new [channel group](#) that contains the same [channels](#), [RGB channels](#), and so forth as the selected channel group.

Degroup

This option from the [channel button popup menu](#) "degroups" the selected [channel group](#). That is, all of the channel group's children are moved to the channel group's parent (unless the parent already contains them), and the channel group itself is removed from the parent.

Delete Channel / Delete RGB Channel

This option from the [channel/RGB channel button popup menu](#) deletes the selected [channel](#) or [RGB channel](#). Note that this will completely delete the channel or RGB channel from the [sequence](#), not just from the current [track](#). If you want to remove the channel or RGB channel from the current track but still keep it in other tracks, use "[Remove Channel from Track / Remove RGB Channel from Track](#)" instead.

Remove Channel from Track / Remove RGB Channel from Track

This option from the [channel/RGB channel button popup menu](#) removes the selected [channel](#) or [RGB channel](#) from the [track](#). If the channel or RGB channel is shared with other tracks, it will remain in those other tracks. If you instead want to delete a channel or RGB channel from the [sequence](#) completely, removing it from all tracks, use "[Delete Channel / Delete RGB Channel](#)" instead.

Copy to Other Track

This submenu of the [channel/RGB channel button popup menu](#) can be used to share the selected [channel](#) or [RGB channel](#) either to a new [track](#) or to an existing track:

- [Copy to New Track](#)
- [Copy to Track Number...](#)

Copy to New Track

This item on the "[Copy to Other Track](#)" submenu of the [channel/RGB channel button popup menu](#) will create a new [track](#) (via the [New Track dialog](#)) and share the selected [channel](#) or [RGB channel](#) with that track.

Copy to Track Number...

This item on the "[Copy to Other Track](#)" submenu of the [channel/RGB channel button popup menu](#) will share the selected [channel](#) or [RGB channel](#) with another existing [track](#) in the [sequence](#). You will be prompted to select which track.

Move

This submenu of the [channel/RGB channel button popup menu](#) can be used to move the selected [channel](#) or [RGB channel](#) up or down within its [track](#), or to another track. Note that a channel or RGB channel can also be moved up or down within its track by clicking and dragging its [channel button](#).

- [Move Up](#)
- [Move Down](#)
- [Move to New Track](#)
- [Move to Track Number...](#)

Move Up

This item on the "[Move](#)" submenu of the [channel/RGB channel button popup menu](#) will move the selected [channel](#) or [RGB channel](#) one slot up in its [track](#).

Move Down

This item on the "[Move](#)" submenu of the [channel/RGB channel button popup menu](#) will move the selected [channel](#) or [RGB channel](#) one slot down in its [track](#).

Move to New Track

This item on the "[Move](#)" submenu of the [channel/RGB channel button popup menu](#) will create a new [track](#) (via the [New Track dialog](#)) and move the selected [channel](#) or [RGB channel](#) to that track.

Move to Track Number...

This item on the "[Move](#)" submenu of the [channel/RGB channel button popup menu](#) will move the selected [channel](#) or [RGB channel](#) to another existing [track](#) in the [sequence](#). You will be prompted to select which track.

5.3.8.3.1 Insert Device

The Insert Device dialog can be used to add several [channels](#) and/or [RGB channels](#) to a [sequence](#), automatically populated with various settings such as their [unit IDs](#) and [circuit IDs](#). The dialog can be opened by right-clicking on a [channel or RGB channel's button](#), and selecting either "[Insert Device Above](#)" or "[Insert Device Below](#)" from the popup menu (which will cause the new device's channels to be inserted above or below the clicked channel, respectively).

At the top of the dialog is a text box where you can specify the base name of the unit. This name will be used to create the names of the channels; additional information, such as the circuit number, may also be included in the names. Under the text box is a check box allowing you to specify whether or not the unit ID (and network, if applicable) are to be included.

Under the "name" section of the dialog is a dropdown list of the available devices, and under that is a

checkbox enabling you to choose whether the device should be added as a [channel group](#) or as raw channels and/or RGB channels.

- [CMB16D](#)
- [Cosmic Color Device](#)
- [DIO32](#)
- [iDMX1000](#)
- [LOR/CTB \(8 Channel\)](#)
- [LOR/CTB \(16 Channel\)](#)
- [LOR/CTB \(32 Channel\)](#)
- [RGB Device \(Non-CCD\)](#)
- [Servo Dog](#)

CMB16D

The CMB16D choice for the [Insert Device dialog](#) will add sixteen [channels](#), with device type [Light-O-Rama](#), a [network](#) and [unit ID](#) that you specify, and [circuit numbers](#) from 1 to 16. The name of a channel will default to "CMB" followed by an indication of the unit and circuit (such as "CMB 03.7" for unit 03 and circuit 7).

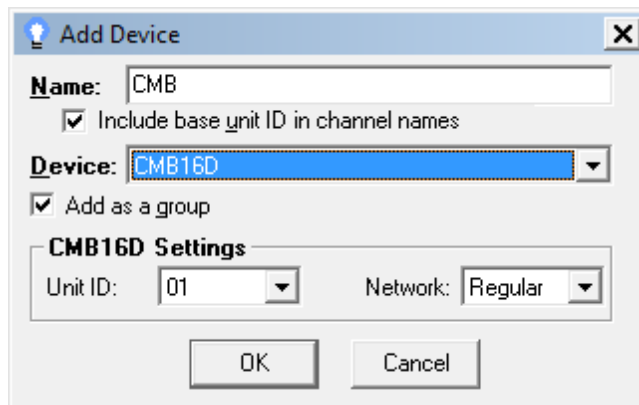

Insert Device: CMB16D

Cosmic Color Device

The Cosmic Color Device choice for the [Insert Device dialog](#) has both a basic and an advanced mode. In basic mode, it will add fifty [RGB channels](#) followed by seven regular [channels](#). All will have device type [Light-O-Rama](#), and a specified [network](#) and [unit ID](#).

The [circuit numbers](#) of the first RGB channel will be red = 1, green = 2, blue = 3, the next RGB Channel will have red = 4, green = 5, blue = 6, and so on, up to the fiftieth RGB channel, which will have red = 148, green = 149, blue = 150. The seven regular channels, which represent the macro channels of the Cosmic Color Device, start at circuit 151 and go through 157.

The names of the RGB channels will default to "CCD" followed by an indication of the unit ID and the pixel number (such as "CCD 03 p7" for unit ID 03 pixel 7). The names of the macro channels will indicate which macro channels they represent, instead of having a pixel number, such as "CCD 03 LR", meaning "Cosmic Color Device, unit 03, Logical Resolution". The full list of abbreviations such as "LR" for "Logical Resolution" is:

- LR: Logical Resolution

- MM: Macro Mode
- MS: Macro Submode
- ME: Macro Effect
- CM: Color Mode
- CS: Color Speed
- CI: Color Intensity

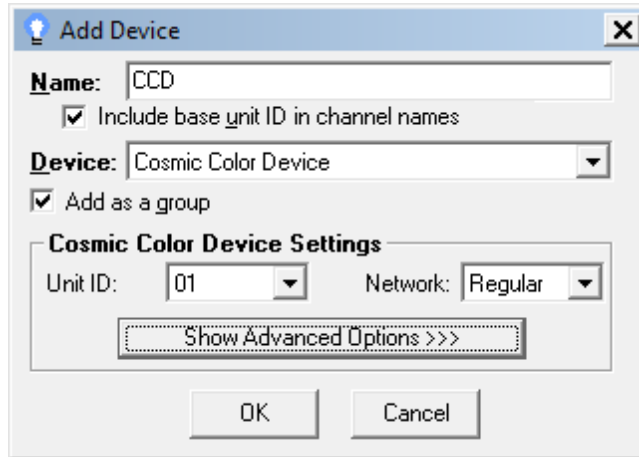

Insert Device: Cosmic Color Device (basic mode)

To use advanced mode, click on the "Show Advanced Options" button:



Insert Device: Cosmic Color Device (advanced mode)

The "Resolution" dropdown controls the number of pixels - i.e. the number of RGB channels - that will be created. Also, macro channels will only be created if the resolution is set to 50 pixels.

When "Unit ID Mode" is set to "Native Mode", all channels and RGB channels on the Cosmic Color Device use a single unit ID (as described above, in basic mode). If it is set to "Legacy Mode", however, circuit IDs will be limited from 1 to 16, and multiple unit IDs will be used. For example, if the selected unit ID is 01, and 50 pixels are chosen, then instead of having unit 01 circuits 1 through 157, the channels and RGB channels to be created will have unit 01 circuits 1 through 16, unit 02 circuits 1 through 16, ..., unit 09 circuits 1 through 16, and unit 0A circuits 1 through 13. The names of all channels and RGB channels will still indicate the base unit ID, though - for example, the fiftieth pixel will be labelled "CCD 01 p50" despite its constituent channels actually using unit ID 09 rather than 01.

When "Channel Mode" is set to "Triples", the circuit IDs are as described above in the "basic mode" section - i.e. the first pixel will have circuit IDs 1, 2, and 3 for red, green, and blue, respectively, the second will have 4, 5, and 6, and so on. If it is set to "Sequential", the circuit IDs will instead be assigned to all of the red channels first, then all of the green channels, then all of the blue channels. For example, with 50 pixels and native unit ID mode, the first pixel will have circuit IDs 1, 51, and 101 for red, green, and blue, respectively, the second will have 2, 52, and 102, and so on.

DIO32

The DIO32 choice for the [Insert Device dialog](#) will add 32 [channels](#), with device type [Light-O-Rama](#) and a specified [network](#). If "Unit ID Mode" is set to "Native Mode", then the specified [unit ID](#) will be used for all 32 channels, which will have [circuits](#) 1 through 32. If it is instead set to "Legacy Mode", then the first sixteen channels will have the specified unit ID and circuits 1 through 16, and the last sixteen channels will have the next unit ID and circuits 1 through 16.

The names of the channels will default to "DIO" followed by an indication of the unit and circuit, such as "DIO 03.7" for unit ID 03, circuit 7.

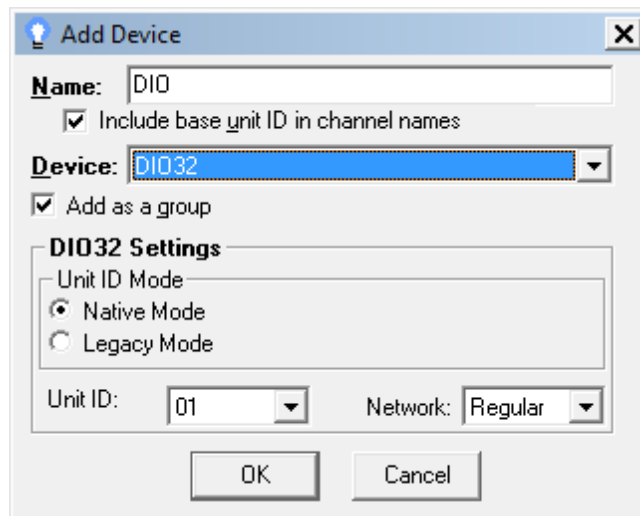

Insert Device: DIO32

iDMX1000

The iDMX1000 choice for the [Insert Device dialog](#) will add anywhere from 16 to 512 [channels](#), in multiples of 16, with device type [Light-O-Rama](#) and a specified [network](#). If "Unit ID Mode" is set to "Native Mode", then a single (specified) [unit ID](#) will be used for all channels, with [circuit IDs](#) ranging

from 1 to the number of channels. If it is set to "Legacy Mode", then circuit IDs will be limited from 1 to 16, and multiple unit IDs will be used (assuming more than 16 channels are selected), starting at the specified unit ID.

The names of the channels will default to "iDMX" followed by an indication of the unit and circuit, such as "iDMX 03.7" for unit 03 circuit 7.

Insert Device: iDMX1000

LOR/CTB (8 Channel)

The LOR/CTB (8 Channel) choice for the [Insert Device dialog](#) will add eight [channels](#), with device type [Light-O-Rama](#) and a specified [network](#) and [unit ID](#), and [circuit IDs](#) ranging from 1 to 8.

The names of the channels will default to "Unit" followed by an indication of the unit and circuit, such as "Unit 03.7" for unit 03 circuit 7.

Insert Device: LOR/CTB (8 Channel)

LOR/CTB (16 Channel)

The LOR/CTB (16 Channel) choice for the [Insert Device dialog](#) will add sixteen [channels](#), with device

type [Light-O-Rama](#) and a specified [network](#) and [unit ID](#), and [circuit IDs](#) ranging from 1 to 16.

The names of the channels will default to "Unit" followed by an indication of the unit and circuit, such as "Unit 03.7" for unit 03 circuit 7.

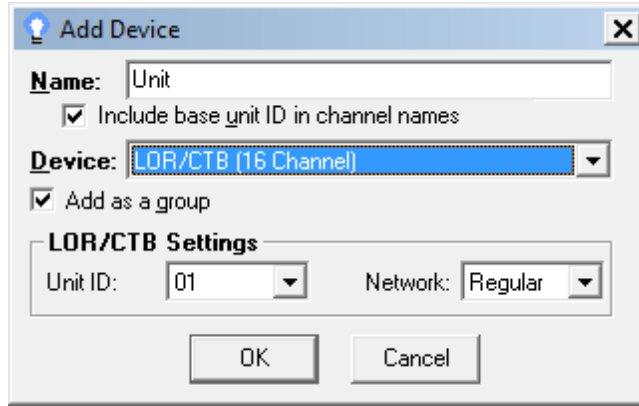

Insert Device: LOR/CTB (16 Channel)

LOR/CTB (32 Channel)

The LOR/CTB (32 Channel) choice for the [Insert Device dialog](#) will add thirty-two [channels](#), with device type [Light-O-Rama](#) and a specified [network](#) and [unit ID](#), and [circuit IDs](#) ranging from 1 to 32.

The names of the channels will default to "Unit" followed by an indication of the unit and circuit, such as "Unit 03.7" for unit 03 circuit 7.

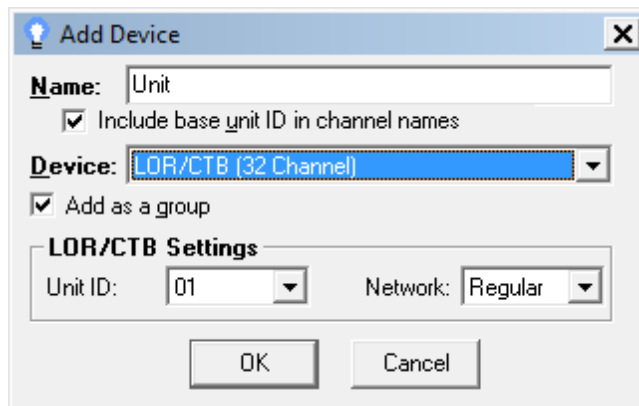

Insert Device: LOR/CTB (32 Channel)

RGB Device (Non-CCD)

The RGB Device (Non-CCD) choice for the [Insert Device dialog](#) will add anywhere from 1 to 16 [RGB channels](#), with device type [Light-O-Rama](#) and a specified [network](#) and [base unit ID](#). Note, though, that you do not specify the number of RGB channels; instead, you specify the number of underlying [channels](#), with three channels corresponding to a single RGB channel. For example, to add 16 RGB channels, select 48 channels.

The reason for specifying the number of channels instead of the number of RGB channels is because the number of channels per unit ID can also be specified (so that, for example, 48 channels

with 16 channels per unit ID will cause three unit IDs to be used, starting from the specified base).

If the "Channel Mode" option is set to "Triples", then the [circuit IDs](#) will be 1 for the red channel of the first RGB channel, 2 for the green channel of the first RGB channel, 3 for the blue channel of the first RGB channel, 4 for the red channel of the second RGB channel, and so on. If it is instead set to "Sequential", then they will instead be 1 for the red channel of the first RGB channel, 2 for the red channel of the second RGB channel, 3 for the red channel of the third RGB channel, and so on through all of the red channels, then through the green channels, then the blue channels.

The RGB channel names will default to "RGB" followed by an indication of the base unit ID plus the pixel number; for example, "RGB 03 p7" for the seventh pixel of the RGB device whose base unit ID is 03.

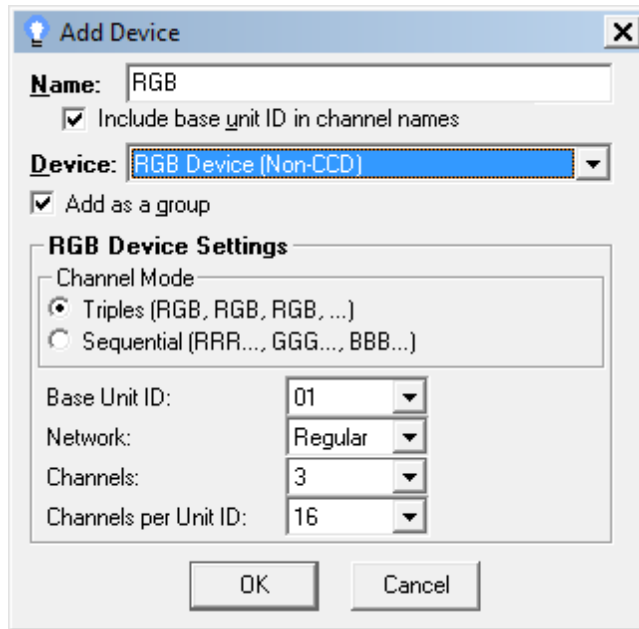

Insert Device: RGB Device (non-CCD)

Servo Dog

The Servo Dog choice for the [Insert Device dialog](#) will add eight [channels](#), with device type [Light-O-Rama](#) and a specified [network](#) and [unit](#). The [circuit IDs](#) will range from 1 to 8.

The names of the channels will default to "SD" followed by an indication of the unit and circuit, such as "SD 03.7" for unit 03 circuit 7.

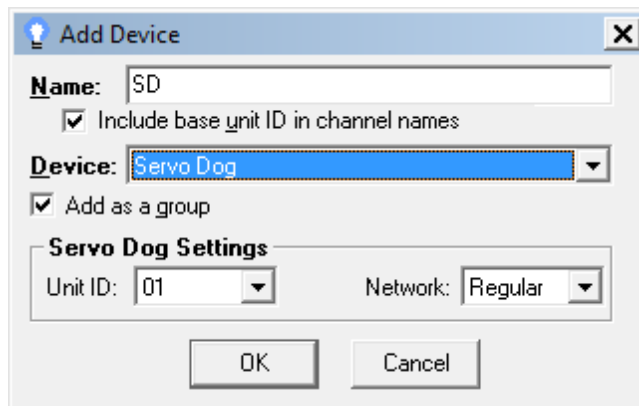

Insert Device: Servo Dog

5.3.8.3.2 Convert to RGB Channel

The Convert to RGB Channel dialog enables you to convert existing [channels](#) into [RGB channels](#). You can open the Convert to RGB Channel dialog by right-clicking on a [channel's button](#), and selecting "[Convert to RGB Channel](#)" from the [popup menu](#). The RGB channel that is created by the dialog will be placed at the erstwhile location of the channel that you click on, and (by default) will use that channel as its red constituent channel, and the immediately following channels (if any) as its green and blue constituent channels.

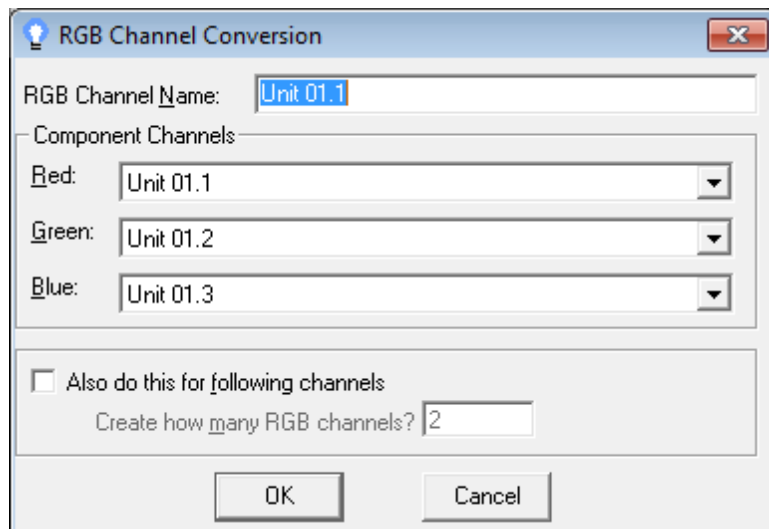

The Convert to RGB Channel dialog

RGB Channel Name

The RGB Channel Name field allows you to specify the name of the RGB channel to be created; by default, it will be the same as the name of the channel that you clicked on. The names of the constituent channels will be changed to reflect the name of the RGB channel; for example, if you name the RGB channel "My RGB", then its red, green, and blue constituent channels will be renamed "My RGB (R)", "My RGB (G)", and "My RGB (B)", respectively.

Component Channels

The three component channel dropdown lists allow you to specify the existing channels to use as

the component channels. Also, the top entry in each list, "Add a new channel", allows you to say that an entirely new channel should be created and used as that component channel, rather than using an existing channel. By default, the red channel will be the channel that you clicked on, the green channel will be the channel following that, and the blue will be the channel following that.

Also Do This for Following Channels

If the "Also do this for following channels" box is checked, you can specify a number of RGB channels to create (otherwise, only one will be created). The dialog will try to create as many as you specify, using succeeding channels from the track. Exactly which channels are used depends upon the relationship between the three channels that you specify in the "Component Channels" section:

The first mode is intended to support sequences whose channels are currently set up in the order R, G, B, R, G, B, R, G, B, and so on. So, if the specified green channel immediately follows the specified red channel, and the specified blue channel immediately follows the specified green channel, then the next RGB channel will be created from the three channels following those (as R, G, and B, respectively), and the RGB channel after that from the three channels following those, and so on. If this causes the dialog to run out of channels before creating the number of RGB channels that you requested (either due to reaching the end of the track or due to reaching an existing RGB channel instead of a channel), it will stop, and warn you that it was only able to create less RGB channels than you had requested.

The other mode is intended to support sequences whose channels are currently set up in the order R, R, R, ..., G, G, G, ..., B, B, B, So, if the specified green channel does not immediately follow the specified red channel, or the specified blue channel does not immediately follow the specified green channel, then the next RGB channel will consist of the channel following the specified red channel as its red channel, the channel following the specified green channel as its green channel, and the channel following the specified blue channel as its blue channel. Again, if this causes it to run out of channels before creating the requested number of RGB channels (either due to the conditions listed previously or else due to reaching a channel that has already been used), it will stop, and warn you that it created less than you asked for.

5.3.8.3.3 Convert to Channel Group

The Convert to Channel Group dialog allows you to group existing [channels](#) (and [RGB channels](#), etc.) into a new [channel group](#). You can open the dialog by right-clicking on the [channel button](#) of the first channel that you want in the new group, and selecting "[Convert to Group](#)" from the popup menu that will open.

In the dialog, select the name that you want to use for the new group, and the first and last channels that you want placed into the new group, and then click on the "Create Group" button. The new group will be created at the same spot that the first selected channel was at, and will contain the specified range of channels.

Optionally, you can choose to "leave copies in their existing locations", causing the new group to be created without actually removing the existing copies of the channels.

If the channels and RGB channels that you have selected look like they might be intended as a Cosmic Color Device -- that is, if they are a certain specific number of RGB channels potentially followed by a certain specific number of channels -- the dialog will give you an option to make the new channel group be a Cosmic Color Device. This has certain advantages over creating it as a normal channel group; for example, the CCD's macro channels will be skipped when chases are done on the group.

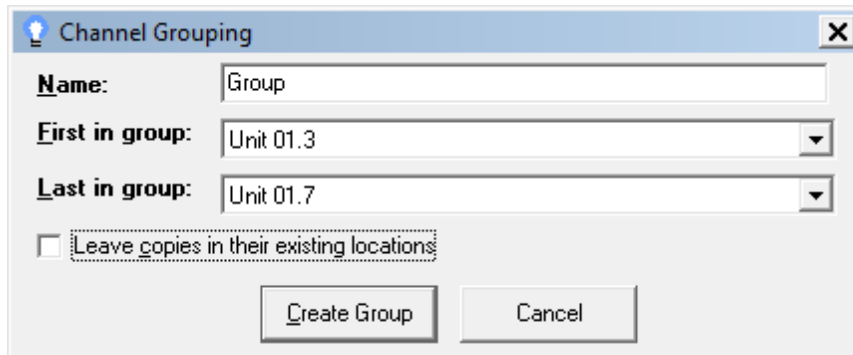

The Convert to Channel Group dialog

5.3.9 Track Bars

If a [sequence](#) contains more than one [track](#), the [Sequence Editor](#) displays each track with a track bar at its top. This bar is labelled with up to three parts:

- "Track <number>", such as "Track 2", with the topmost track being "Track 1", the next being "Track 2", and so on;
- If the track has been assigned a name, the name is displayed after the track number;
- If the track's grid has been hidden, the label will additionally say "(hidden)".

The track bar of the currently active track is usually colored green, so as to make that track easily distinguishable from the other tracks, which are usually shown in grey. The exceptions are for [locked tracks](#), which show in magenta if active and red if not.

Left-clicking on a track bar will [hide or unhide the track](#), while right-clicking on one will bring up a the [track bar's popup menu](#), which allows access to various functionality related to the track. For example, you can use the popup menu to [move the track up](#) or [down](#) in the sequence, [hide or unhide the track](#), or [duplicate the track](#) to another track.

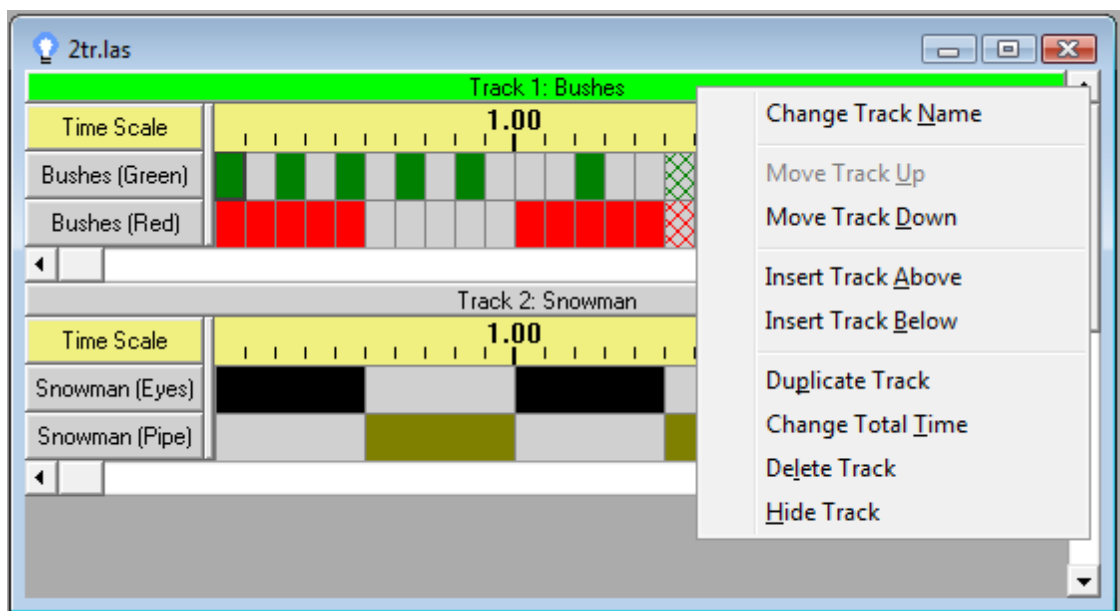

A sequence with two tracks, with track bars at their tops, and the track bar popup menu displayed. The first track is currently the active track, which can be seen from the fact that its track bar is green.

5.3.9.1 Track Bars' Popup Menus

If a [sequence](#) has more than one [track](#), the [Sequence Editor](#) displays a [track bar](#) at the top of each. Right-clicking on a track bar opens up a popup menu containing various functions related to the track. These include:

- [Change Track Name](#)
- [Move Track Up](#)
- [Move Track Down](#)
- [Insert Track Above](#)
- [Insert Track Below](#)
- [Duplicate Track](#)
- [Change Total Time](#)
- [Delete Track](#)
- [Lock or Unlock Channels](#)
- [Hide or Show Track](#)

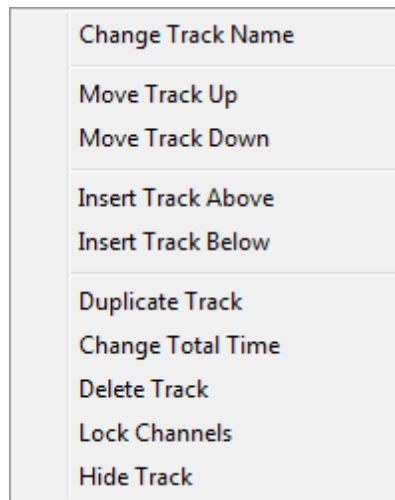

The track bar popup menu

Change Track Name

This item on the [track bar popup menu](#) can be used to change the name of the [track](#), or assign a name if the track does not already have one. If a track is given a name, it will be displayed on that track's [track bar](#) (among other places).

This is equivalent to "[Change Track Name](#)" on the [Edit menu](#).

Move Track Up

This item on the [track bar popup menu](#) will move the [track](#) up a single slot in the [sequence](#).

Note that this will cause the label on the track's [track bar](#) to change - for example, if track 3 is moved up, it will become track 2, and what had been track 2 will become track 3. However, if either of the tracks have names, their names will remain the same. For example, if "Track 3: Funky Bass Line" is moved up, its track bar will be relabelled "Track 2: Funky Bass Line", and if the previous

track 2 had been named "Awesome Guitar Solo", its track bar will be changed from "Track 2: Awesome Guitar Solo" to "Track 3: Awesome Guitar Solo".

Move Track Down

This item on the [track bar popup menu](#) will move the [track](#) down a single slot in the [sequence](#).

Note that this will cause the label on the track's [track bar](#) to change - for example, if track 2 is moved down, it will become track 3, and what had been track 3 will become track 2. However, if either of the tracks have names, their names will remain the same. For example, if "Track 2: Funky Bass Line" is moved down, its track bar will be relabelled "Track 3: Funky Bass Line", and if the previous track 3 had been named "Awesome Guitar Solo", its track bar will be changed from "Track 3: Awesome Guitar Solo" to "Track 2: Awesome Guitar Solo".

Insert Track Above

This item on the [track bar popup menu](#) can be used to create a new [track](#), via the [New Track dialog](#), and insert that new track into the [sequence](#) just above the selected track.

Insert Track Below

This item on the [track bar popup menu](#) can be used to create a new [track](#), via the [New Track dialog](#), and insert that new track into the [sequence](#) just below the selected track.

Duplicate Track

This item on the [track bar popup menu](#) can be used to duplicate the selected [track](#) to a new track, which will be inserted at the bottom of the [sequence](#).

This is equivalent to "[Duplicate Track](#)" on the [Edit menu](#).

Change Total Time

This item on the [track bar popup menu](#) can be used to change the duration of the selected [track](#). Note that all tracks in a [musical sequence](#) (as opposed to an [animation sequence](#)) must have the same duration, so changing the duration of one track in a musical sequence will automatically change the duration of all others.

This is equivalent to "[Change Total Time](#)" on the [Edit menu](#).

Delete Track

This item on the [track bar popup menu](#) can be used to delete the selected [track](#) from the [sequence](#).

Lock or Unlock Channels

This item on the [track bar popup menu](#) can be used to lock or unlock the [channels](#) of a [track](#). When a track's channels are locked, channels cannot be added to it, removed from it, or moved within it. Also, its settings such as name, device type, unit and circuit cannot be modified from within the track (although they can be modified from within other tracks, if those other tracks are not

locked).

The [effects](#) of channels in a locked track can still be modified.

A locked track's [track bar](#) will show in red instead of grey, or, if it is the active track, magenta instead of green.

Hide or Show Track

This item on the [track bar popup menu](#) can be used to hide or unhide the [track's](#) grid. When a track's grid is hidden, only the [track bar](#) will remain visible, and it will be relabelled to indicate that the track has been hidden. To unhide a track that has been hidden, click on the track bar to open the popup menu again, and select "Show Track".

You can also hide or unhide a track simply by left-clicking on its track bar.

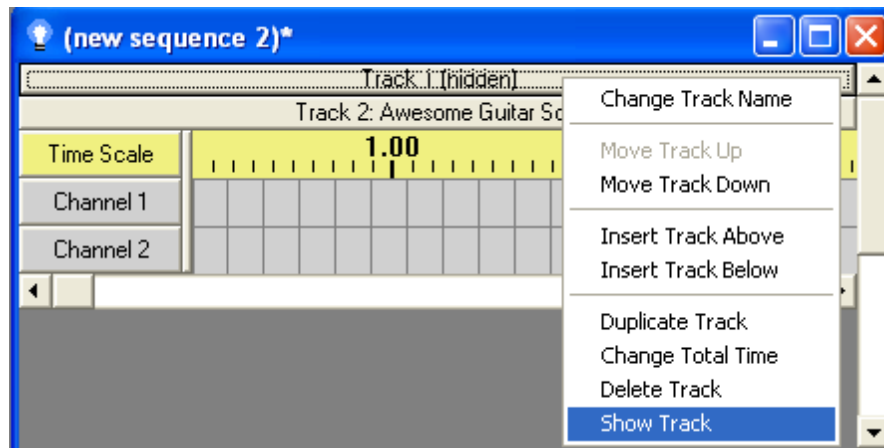

The grid for the first track is hidden

5.3.10 Loop Menus

The [Light-O-Rama Sequence Editor](#) has two popup menus for dealing with [loops](#):

First, clicking on the grid in a loop level opens the [Loop Context menu](#) (loop levels can be recognized as the rows with white background and buttons, as opposed to the light grey of [channels'](#) rows; they are located above the channels, but below the time scale). This can be used, for example, to add, delete, change, or view information about loops, as well as to add or delete loop levels.

Second, clicking on a [loop level's button](#) will bring up a menu that contains a subset of the items of the Loop Context menu. Specifically, it includes those items that deal with the loop level, as opposed to loops on that loop level.

If your [sequence](#) does not contain any loop levels, but you want to add loops to it, first use "[Turn On Loops](#)" from the [Edit menu](#). This will insert a loop level into the sequence. Note that loops can only be used in [animation sequences](#), not in [musical sequences](#).

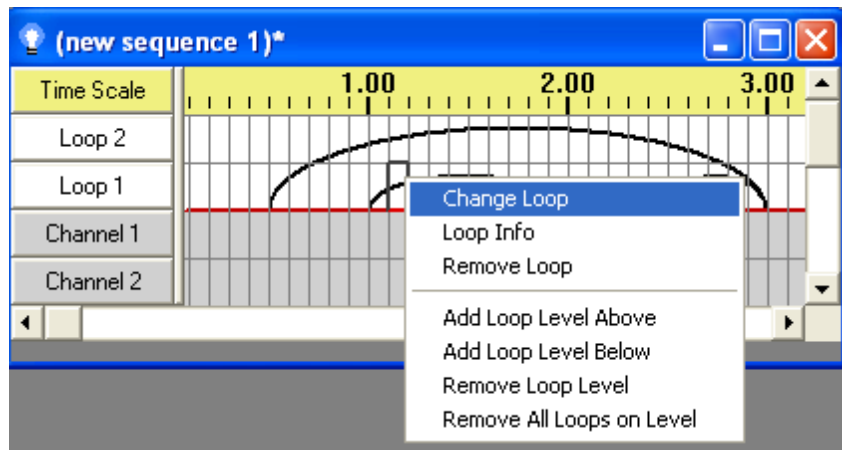

The Loop context menu

5.3.10.1 The Loop Context Menu

The [Sequence Editor's](#) Loop Context menu gives access to various [loop](#)-related functionality. It can be accessed by clicking on the grid in a loop level's row (which can be recognized by its white background, as opposed to the light grey of [channels](#); loop levels' rows are located above the channels' rows but below the time scale).

Different menu items are available depending upon whether a loop already exists at the spot clicked; for example, if one does, there is a menu item to delete it; if none does, there is instead a menu item to insert one.

Those portions of the menu that deal with loop levels (as opposed to loops) can also be accessed by clicking on a [loop level button](#).

The items on the menu include:

- [Insert Loop](#)
- [Change Loop](#)
- [Loop Info](#)
- [Remove Loop](#)
- [Add Loop Level Above](#)
- [Add Loop Level Below](#)
- [Remove Loop Level](#)
- [Remove All Loops on Level](#)

Insert Loop

This item on the [Loop Context menu](#) inserts a [loop](#) in the selected cell or cells on the selected loop level. After clicking it, you will first be asked how many times the loop should loop back (for example, to play through a loop twice, it should loop back once):

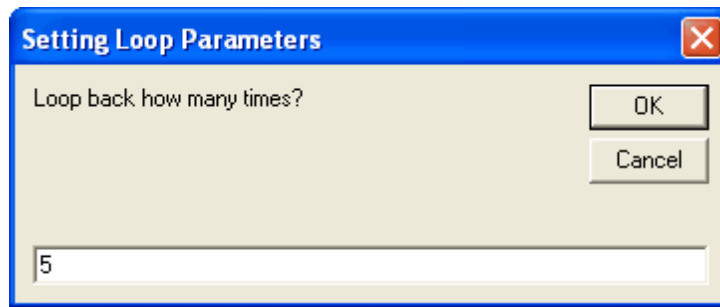

Looping back five times will cause six passes through the loop

After that, you will be prompted to say whether (and by how much) it should speed up, slow down, or remain at the same speed with each successive pass through the loop:

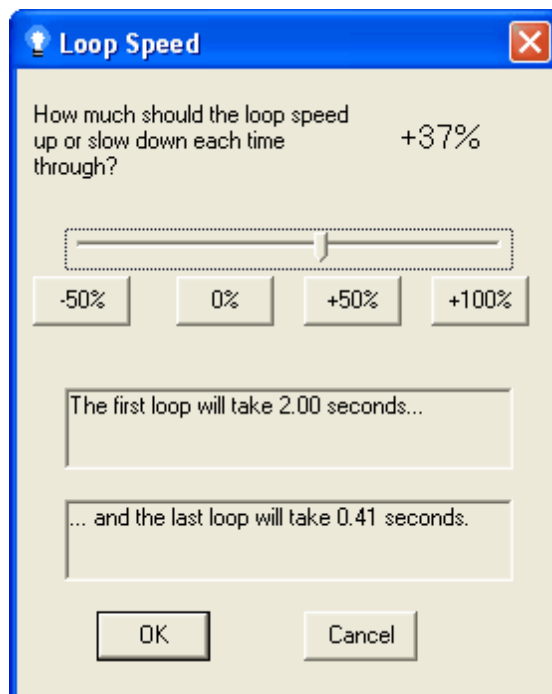

This loop will speed up by 37% with each successive pass

This menu item is available only if no loop exists in any of the selected cells on the selected loop level.

Change Loop

This item on the [Loop Context menu](#) can be used to change the settings of the selected [loop](#) - i.e. the number of times that it will loop back, and the speed change (if any) with each successive pass. Using it is very similar to using "[Insert Loop](#)"; please see that help file entry for details.

This menu item is available only if the popup menu is opened by clicking on an existing loop.

Loop Info

This item on the [Loop Context menu](#) displays information about the selected [loop](#), such as how

many times it loops back, and the speed change (if any) with each successive pass.

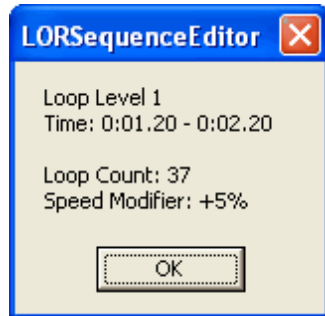

The Loop Info window

This menu item is available only if the popup menu is opened by clicking on an existing loop.

Remove Loop

This item on the [Loop Context menu](#) can be used to delete an existing [loop](#).

This menu item is available only if the popup menu is opened by clicking on an existing loop.

Add Loop Level Above

This item on the [Loop Context menu](#) can be used to add another loop level to the [sequence](#), above the selected loop level. [Loops](#) on the new (higher) level can contain loops within the preexisting (lower) level.

Add Loop Level Below

This item on the [Loop Context menu](#) can be used to add another loop level to the [sequence](#), below the selected loop level. [Loops](#) on the preexisting (higher) level can contain loops within the new (lower) level.

Remove Loop Level

This item on the [Loop Context menu](#) can be used to delete the entire selected loop level, including all [loops](#) on it.

If you wish to delete all of the loops on a level, but to keep the level itself, use "[Remove All Loops on Level](#)" instead.

If you have removed all of the loop levels from a [sequence](#), but later decide that you want to use loops, use "[Turn On Loops](#)" from the [Edit menu](#). Doing so will add a loop level to the sequence.

Remove All Loops on Level

This item on the [Loop Context menu](#) can be used to delete all of the [loops](#) on the selected loop level, but to keep the loop level itself.

If you wish to additionally delete the loop level itself, use "[Remove Loop Level](#)" instead.

5.3.10.2 Loop Level Buttons

[Loops](#) in a [sequence](#) can be grouped into loop levels. Loops on a higher level can contain loops on lower levels.

In the [Sequence Editor](#), loop levels are displayed as white rows, above the [channels'](#) rows and below the time scale. On the left of each loop level's row is that loop level's button:

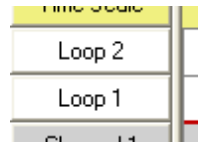

Loop level buttons

The bottom loop level in a sequence is always labelled "Loop 1"; the one immediately higher than that is labelled "Loop 2", and so on.

Clicking on a loop level's button will bring up a portion of the [Loop Context menu](#) (specifically, those menu items dealing with loop levels, as opposed to loops). You can use this, for example, to delete the loop level, remove all of the loops from it, or add a new loop level above or below the selected level.

If you wish to add loops to a [sequence](#) but it does not currently have any loop levels, use "[Turn On Loops](#)" from the [Edit menu](#). Doing so will add a loop level to the sequence. Note that this is only possible in [animation sequences](#), since [musical sequences](#) cannot contain loops.

5.3.11 The Waveform

For certain types of [musical sequences](#) (those based on WAV, MP3, or WMA audio files), the [Sequence Editor](#) can display a waveform of the audio at the top of each [track](#). This can be useful for visually matching up [timings](#) and [events](#) to the sound.

In addition to the waveform itself, a vertical highlight bar is displayed at the current time that your mouse is pointing at.

- [Viewing the waveform](#)
- [Scaling up and down](#)
- [Changing the display type](#)
- [Changing the colors](#)

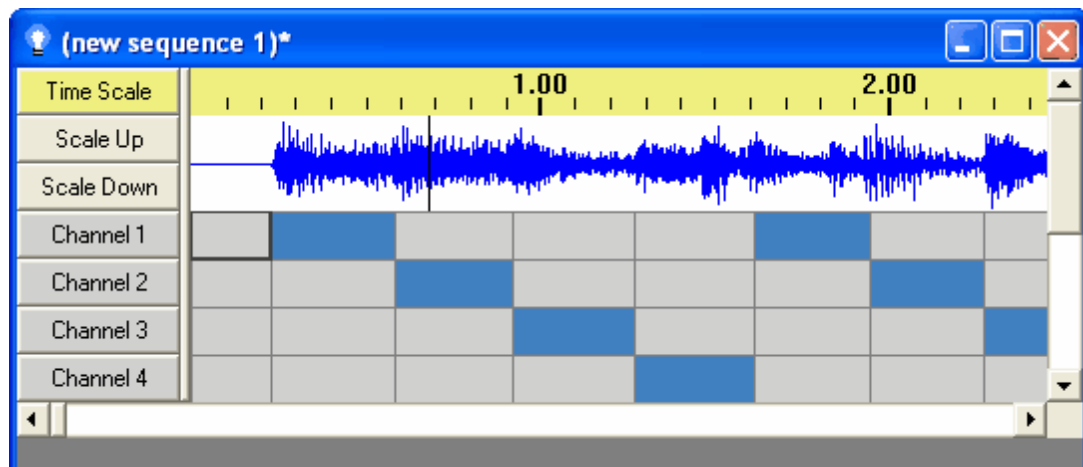

A musical sequence with an audio waveform displayed

Viewing the Waveform

[Waveforms](#) can only be displayed for certain types of [musical sequences](#) - those based on WAV, MP3, or WMA audio files. To view the waveform for such a file, make sure that "[Wave Form](#)" on the [View menu](#) is set to either "Full Height" or "Half Height". To hide the waveform, set it to "Off".

"Full Height" or "Half Height" determines the size of the whole display. This should not be confused with [scaling up and down](#), which will keep the size of the display the same, but vary the size of the graph within the display.

The [View Wave Form button](#) on the [Standard Toolbar](#) can be used to toggle between "Off" and whichever of "Full Height" and "Half Height" was last selected.

Additionally, "[View Wave Form by Default](#)" in the [Display Preferences dialog](#) can be used to control whether or not a waveform will automatically be displayed whenever a musical sequence (of an appropriate type) is opened or created.

Scaling Up and Down

When displaying a [waveform](#), the [Sequence Editor](#) tries to automatically scale the graph's vertical size so that a lot of the wave is displayed. There may be occasional spots where the wave goes past the top of the display - corresponding to very loud spots in the audio - but these should be infrequent.

However, you may want to zoom in or out. To do this, click on the "Scale Up" or "Scale Down" buttons to the left of the waveform display. Note that these buttons are visible if and only if the [channel buttons](#) are visible.

If you do zoom in or out, the Sequence Editor will remember your zoom settings for this particular sequence for whenever you open it in the future.

This should not be confused with the "[Full Height](#)" and "[Half Height](#)" options, which change the size of the entire display, rather than the size of the graph on the display.

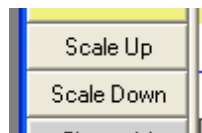

The scaling buttons



A portion of a waveform, scaled up



The same waveform, scaled down

Changing the Display Type

By default, the [waveform](#) display is centered about a line corresponding to zero volume. Loud portions of the song will extend both far above and far below the center. This is known as "full mode".



A portion of a waveform, in full mode

Two other modes are also supported: "fold mode" and "top mode".

"Fold mode" shows zero volume at the bottom of the display, and above it shows whichever half of full mode would be larger, as if the two halves were folded at the center and lain on top of each other. It is then stretched vertically so that the full size of the display is used.

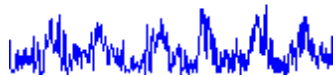

The same waveform, in fold mode

"Top mode" is similar to fold mode, except that only those portions of the display which would have been above the center in full mode are shown.



The same waveform, in top mode

To change between the modes, right-click on the wave form, and choose the desired mode from the popup menu.

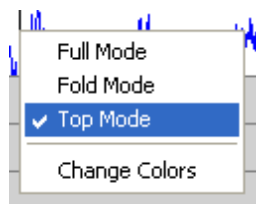

The waveform popup menu, with top mode selected

When you choose a mode, the [Sequence Editor](#) automatically saves it, and uses it as the default mode in the future.

Changing the Colors

The colors used to display the [waveform](#) can be changed via the Wave Colors dialog, which can be opened by right-clicking on the waveform and selecting "Change Colors" from the popup menu:

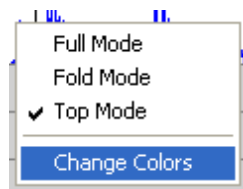

"Change Colors" on the waveform popup menu

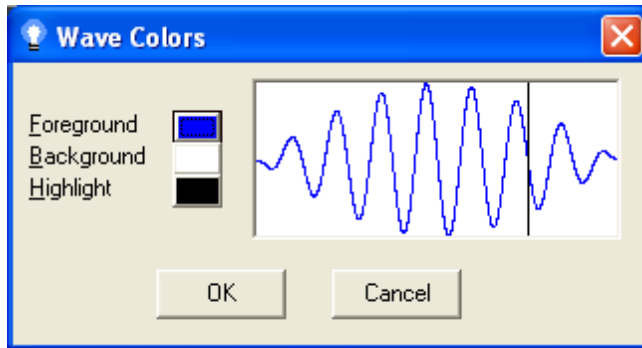

The Wave Colors dialog

Three different colors can be set: "Foreground" is the color of the wave itself; "background" is the field that it is drawn upon; "highlight" is the vertical bar showing the position of the mouse.

The colored buttons on the left can be used to set each of these three colors, and the display on the right shows how a sample waveform would look using these colors.

The [Sequence Editor](#) will remember the colors that you chose, so that other waveforms will automatically be displayed using those colors.

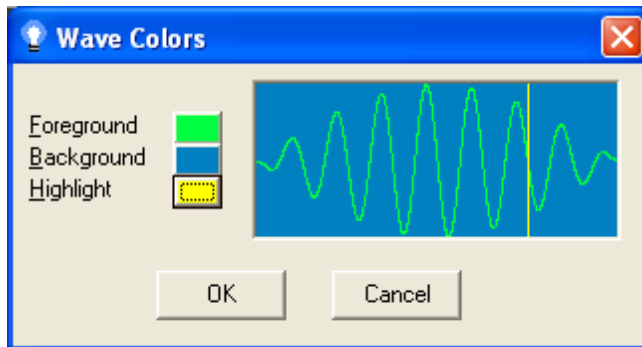

The Wave Colors dialog, with different colors chosen

5.3.12 The Animator

NOTE: The Animator was created before the [Light-O-Rama Visualizer](#) existed; the Visualizer is more fully featured than the Animator. The Animator is still supported so that existing sequences continue to work, but consider using the Visualizer instead of the Animator, especially for new sequences.

Each [sequence](#) can have an [animation](#) associated with it. This is a simple drawing indicating how your lights will be laid out, optionally with a background picture (such as a photograph of your house). When the [Sequence Editor](#) plays a sequence, you can display its animation, and the lights drawn on it will turn on and off, fade, shimmer, and twinkle, as your real lights will.

To view the animation for a sequence, click on the "[View Animation](#)" button in the [standard toolbar](#), or "[Animation](#)" under the [View menu](#). Note that the animations for multiple sequences can be viewed simultaneously, and you can control whether or not each sequence's animation is displayed independently.

During play, the Animator only redraws the [animation](#) every so often, rather than every time that

something changes. This is to try to ensure that it does not use too much CPU time. You can [modify](#) the time between redraws in the [Display Preferences dialog](#), to try to strike an appropriate balance between CPU usage and smoothness of display for your individual computer.

- [Sizing the Animation](#)
- [Drawing in the Animator](#)
- [Background Images](#)
- [Showing and Hiding Controls](#)
- [Playing the Sequence](#)

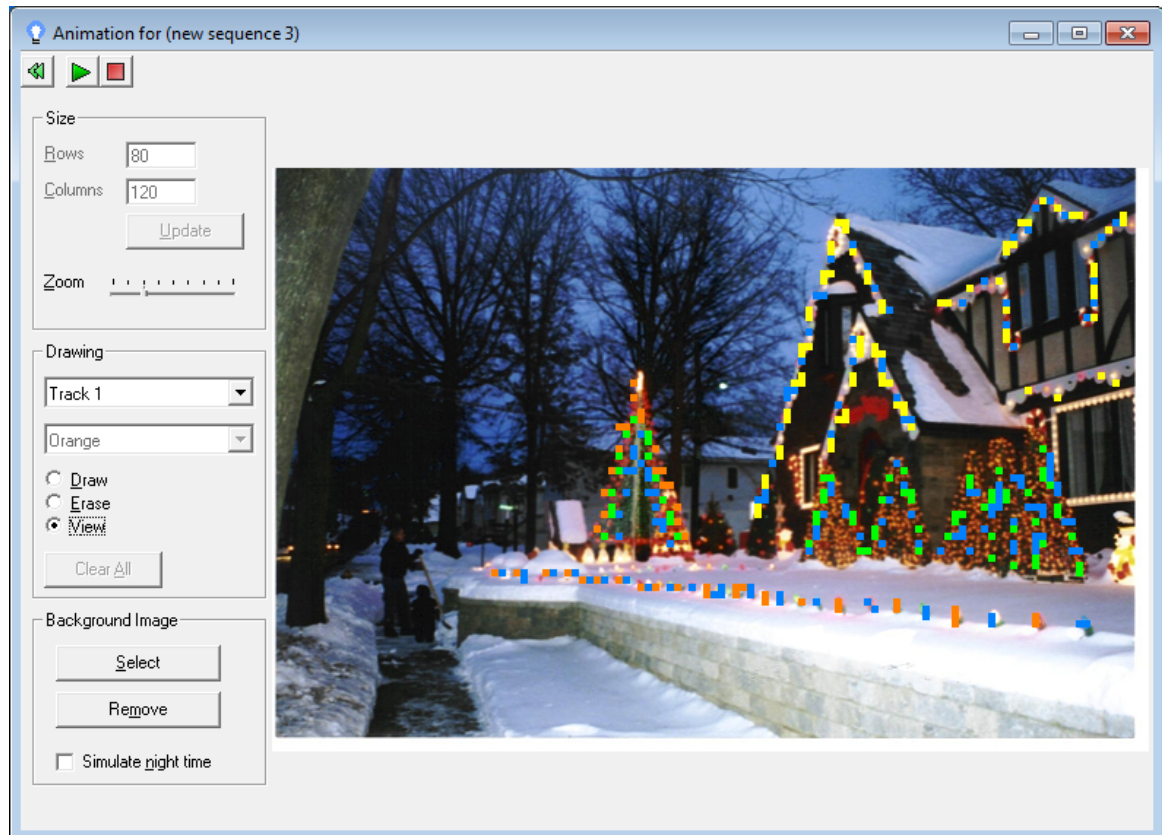

The Animator

Sizing the Animation

If your [animation](#) does not contain a [background image](#), you can change the number of rows and columns in it by using the controls in the "Size" section of the [Animator](#) (if it does contain a background image, you will have chosen the number of rows and columns when choosing the image).

You can also zoom in and out on the animation. This does not affect the number of rows and columns; it only affects their displayed size.

Drawing in the Animator

To draw in the [Animator](#), select "Draw" from the "Drawing" section, choose which [channel](#) or [RGB channel](#) you want to draw for (first choosing the track it is in if you have more than one), and simply

click on spots in the [animation](#) that you want associated with that channel or RGB channel. You can also click and drag, to draw as if you were holding a pen down to paper.

Only a single channel or RGB channel can be assigned to a cell in the animation, so if you draw over a cell that had had another channel assigned to it, only the new channel will thereafter be assigned to that cell.

The drawing will be done in the color that you chose for the channel, or, in the case of an RGB channel, white (which will vary during play). To choose a color for a channel, see the [Channel Settings dialog](#), the [Channel Configuration screen](#), or "[Change Color](#)" in the [channel button's right-click popup menu](#).

There are two ways to erase channels from a cell: First, using "Erase" from the "Drawing" section, you can erase cells in much the same way as you drew them, by clicking or clicking and dragging. Second, while "Draw" is active, you can erase by right-clicking or right-clicking and dragging.

You can also erase all cells in the sequence at once, using the "Clear All" button.

Background Images

If you wish, you can give each [animation](#) a background image. For example, using a photo of your house might make it easier to visualize how your lights will actually look when they are put on your house.

To add a background image to an animation, click on the "Select" button in the "Background Image" section of the [Animator](#). You will be prompted to select how many rows and columns should be in the animation.

To remove an existing background image, click the "Remove" button.

The "Simulate night time" checkbox will cause the background image to appear a bit darker than it normally does, while keeping your drawing (representing your lights) at full brightness.

Showing and Hiding Controls

The various controls on the [Animator](#), such as the "Size", "Draw", and "Background Image" sections, can be hidden by clicking on the toolbar button in the upper left corner, showing two green arrows pointing to the left. This leaves more room for the actual [animation](#).

When the Animator has its controls hidden, two additional buttons appear on the toolbar, allowing the drawing to be resized larger or smaller.

When the controls are hidden, that button will change to show the arrows pointing to the right instead. Simply click on it again to unhide them.

Playing the Sequence

You can play a [sequence](#) (or stop play) directly from the [Animator](#), by clicking the play and stop toolbar buttons at its top. You can also play (or stop) from outside the Animator - for example, via the [Play button](#) on the [Sequence Editor's Standard toolbar](#).

5.3.13 The Beat Wizard

The [Light-O-Rama Sequence Editor's Beat Wizard](#) can analyze the song associated with a [musical sequence](#) to try to determine its tempo, and can insert [timings](#) and [lighting effects](#) into the [sequence](#) based upon it. These are not necessarily inserted exactly the same distance apart from each other; rather, the Beat Wizard attempts to match them up with peaks in the audio that are near the tempo. This is to allow for subtle variation in the speed of the song.

The Beat Wizard is available as an option when [creating a musical sequence](#) or a [new track](#), and can later be accessed via "[Beat Wizard](#)" on the [Tools menu](#).

Not all types of media files are supported. For example, the Beat Wizard cannot be used with video files or MIDI files. If the Beat Wizard cannot be used with the media file for the sequence, it will simply be unavailable from this menu and these dialogs. Also, the Beat Wizard may not be able to be used with very large files.

- [Selecting the Time Range](#)
- [Selecting the Tempo](#)
- [Previewing](#)
- [What To Do with Beats](#)

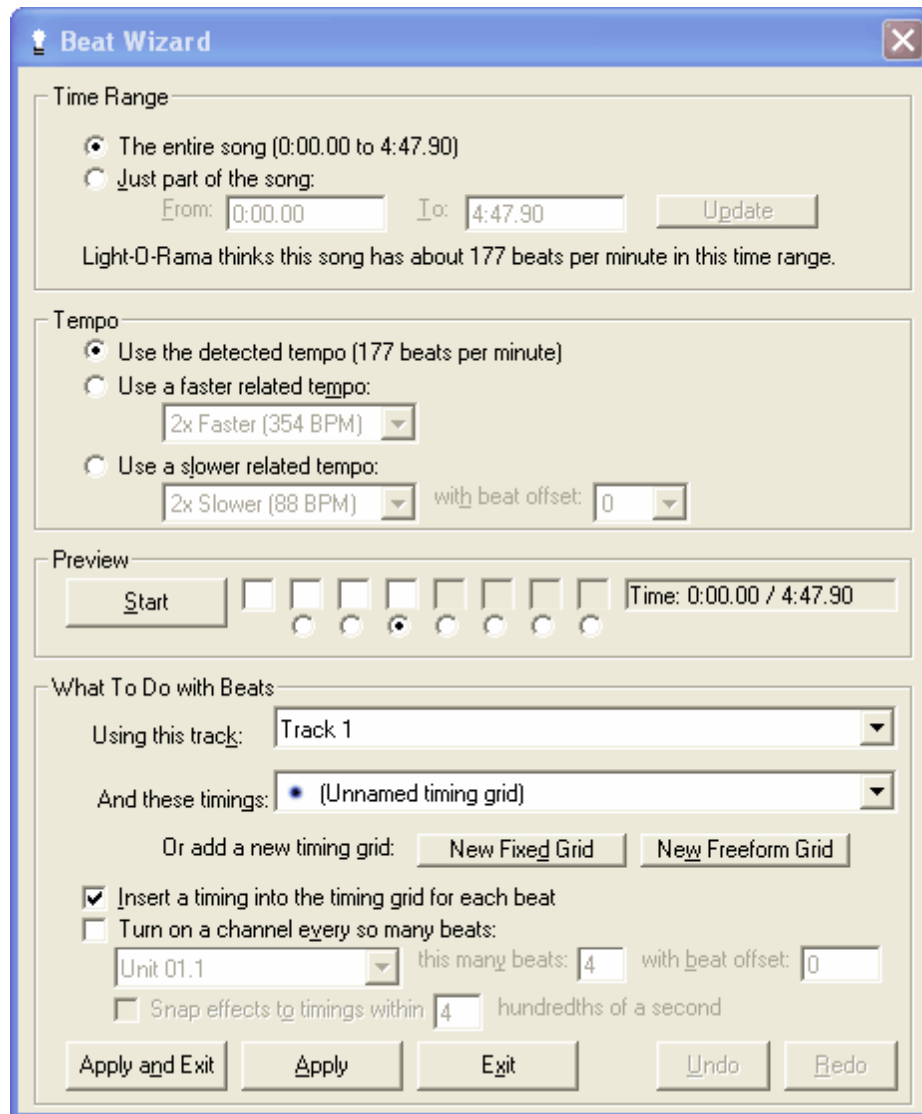

The Beat Wizard

Selecting the Time Range

The [Beat Wizard](#) can try to determine the tempo of a song as a whole, or of just a portion of the song. Use the "Time Range" settings to tell it which to try. If you select a portion of the song, be sure to click the "Update" button after changing the "From" or "To" times.

Choosing a portion of the song is useful if the song's tempo changes; the Beat Wizard will be more accurate if it only is asked to operate on a section with a near-constant tempo throughout. It may also be useful if the Beat Wizard has a problem with a certain portion of a song; if the beats seem off in a particular spot, you may want to try running the Beat Wizard on that spot individually.

When the wizard is first opened, the time range will be automatically set depending upon "[Use Play Range for Wizards](#)" from the [Play Preferences dialog](#): If this option is enabled, the range will be set to the [freemove play range](#) if one exists, or the [play range](#) as set on the [Play menu](#) if not. If the option is not enabled, the range will be set to the entire song. One exception is when the wizard is opened directly from the [New Musical Sequence dialog](#); in this case, the range will be set to the

entire song regardless of the value of "Use Play Range for Wizards".

Selecting the Tempo

The [Beat Wizard](#) shows its best guess as to the tempo of the [selected portion of the song](#). You can choose to use that tempo, or faster or slower related tempos - for example, three times as fast, or twice as slow. Depending upon the song, one of the related tempos may seem more natural when you [preview](#) it.

Another use of related tempos is to simply insert more timings, allowing for faster lighting effects to be used that are still synchronized to the beat of the song. For example, it is unlikely that a "10x Faster" tempo will seem "more natural" in any sense, because it will probably be too quick to count along with. However, selecting it will, for example, let you set up a [lighting effect](#) with ten different [channels](#) that looks like the lights are quickly chasing each other to the beat of the music.

If a slower related tempo is chosen, you must also choose a "beat offset" to determine which beats of the "best guess" tempo will be selected: You might feel that the best guess tempo is actually twice as fast as it should be - that you would count along to it as "one - and - two - and" instead of "one - two - three - four", for example. If you therefore choose a "2x Slower" tempo, the Beat Wizard will use only every other beat from its "best guess" tempo, but it doesn't know whether to use every first beat or every second beat. So, you can let it know which to use by selecting the "beat offset".

Previewing

After you choose a tempo to use in the [Beat Wizard](#), you can get an idea of what it will make your lights look like by using the controls in the "Preview" section. Simply click "Start" to start the preview.

The boxes to the right of the button will light up sequentially, in time with the tempo. Only the white boxes will be used; the greyed out boxes will not. However, you can choose how many white boxes there are by selecting the radio button under one of the boxes.

This allows you to make the preview section look more natural - for example, the boxes lighting up sequentially in a song that you count along with as "one, two, three, one, two, three" will look most natural if you select three boxes - doing so will make the same box light up every time you count the same number.

Clicking directly in one of the boxes will reset it so that that box lights up at that moment (and the other boxes follow sequentially from there). This is also useful for making the preview seem more natural - for example, the third box might be lighting up every time that you count "one", and if so, it might look more natural if you reset it so that the first box lights up at that time instead.

None of this has any effect on the [timings](#) or [lighting effects](#) that will be inserted into the [sequence](#) when you decide [what to do with beats](#) - it is merely to help you see how the selected tempo looks in relation to the song.

Finally, if you are unsatisfied with the selected tempo, simply [choose another tempo](#), or [choose a different portion of the song to analyze](#).

What To Do with Beats

When you have [selected a time range](#) and a [tempo](#) for the [Beat Wizard](#) to use, and are satisfied

with it after [previewing](#) it, you can use the controls in the "What To Do with Beats" section to insert [timings](#), [lighting effects](#), or both, based upon the selected tempo into the [sequence](#) .

If you choose "Turn on a channel every so many beats", you will also have to specify the [channel](#), the number of beats, and a "beat offset". For example, to make a set of four channels chase each other in time with the beat, you could:

- Select the first channel, four beats, and a beat offset of zero;
- Click "Apply";
- Select the second channel, four beats, and a beat offset of one;
- Click "Apply";
- Select the third channel, four beats, and a beat offset of two;
- Click "Apply";
- Select the fourth channel, four beats, and a beat offset of three;
- Click "Apply and Exit".

Note that you can apply multiple effects to different channels, all in the same use of the Beat Wizard, by using "Apply" multiple times. You can even apply effects based on different portions of the song or different tempos, all without leaving the Beat Wizard.

5.3.14 The Channel Configuration Screen

The [Sequence Editor's](#) Channel Configuration screen shows a list of the [channels](#) in a [sequence](#), along with their properties such as their name, color, [unit ID](#), and [circuit ID](#). It can also be used to modify all of those properties, and it includes ways to add, change or delete channels (including all channels for a [controller](#)) and to print out a list of the channels and their properties:

- [Selecting a Track](#)
- [The Channel List](#)
- [Print](#)
- [Add Controller](#)
- [Change Controller](#)
- [Delete Controller](#)
- [Add Channels](#)

[RGB channels](#) and [channel groups](#) are not listed in the Channel Configuration screen, but their constituent channels (e.g. the red, green and blue channels which comprise an RGB channel) are.

The Channel Configuration screen can be opened via "[Channel Configuration](#)" on the [Tools menu](#).

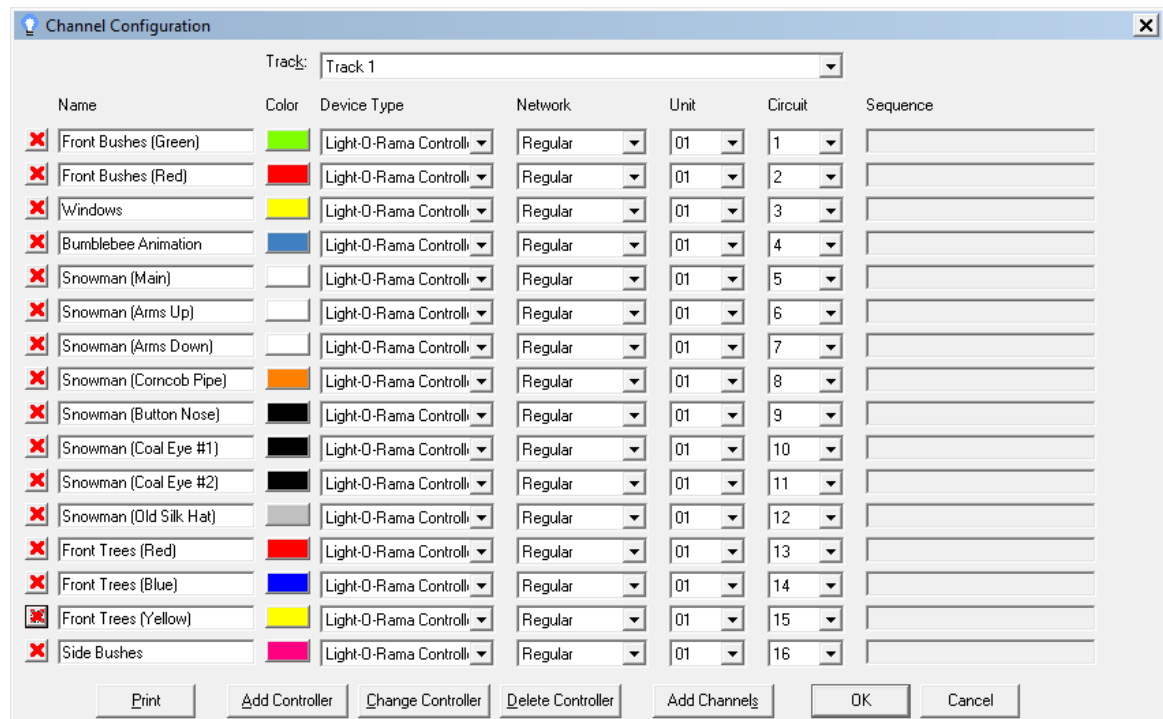

The Channel Configuration screen

Selecting a Track

At the top of the [Channel Configuration screen](#) is a dropdown box listing the [tracks](#) in the [sequence](#). Only the [channels](#) in the selected track will be displayed at any given time. To view the channels in another track, simply choose that track in the dropdown box.

When the Channel Configuration screen is opened, this defaults to the currently active track.

The Channel List

The [Channel Configuration screen](#) displays each [channel](#) in the selected [track](#) on its own row, along with its various properties such as its name, color, and device type, allowing changes to be made to these properties. Note that not all properties will be available for all channels - for example, [X10 controllers](#) do not have circuit IDs, and only channels representing [subsequences](#) will allow a sequence file to be specified.

On the left of each channel's row is a red X button. Clicking this will remove that channel from the selected track. If the channel had been shared with other tracks, it will *not* be removed from those tracks.

Print

This button on the [Channel Configuration screen](#) will print out the [channel](#) list, including the channels' properties (such as name, unit ID, and circuit ID).

Add Controller

This button on the [Channel Configuration screen](#) can be used to add several [channels](#) to the selected [track](#) at once, all for a single [controller](#). You can specify the type of controller, as well as its network, unit ID and number of channels. The newly created channels will automatically have their device type, network, unit ID, and circuit ID set appropriately.

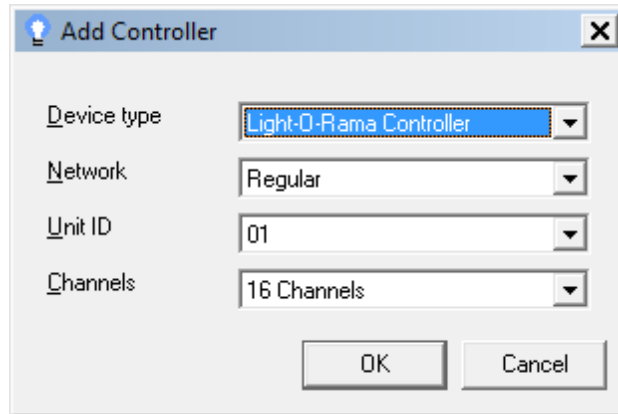

The Channel Configuration screen's "Add Controller" dialog

Change Controller

This button on the [Channel Configuration screen](#) can be used to change the settings (such as [unit ID](#)) of several [channels](#) from a selected [track](#) all at once, all for a single [controller](#). Pressing it will open the Change Controller dialog, from which you can select a controller and then change its settings.

Note: The Change Controller dialog will *not* change the names of your channels, even if the names are based upon the existing channel settings. For example, if you change LOR unit 03 to LOR unit 07, and the channels for LOR unit 03 had been named "Unit 03.1", "Unit 03.2", and so on, they will keep those same names, even though their actual unit IDs change from 03 to 07.

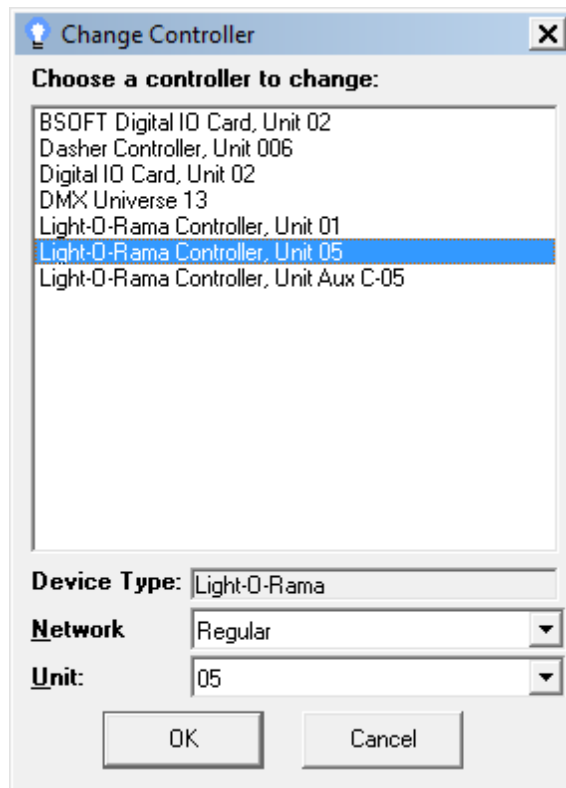

The Change Controller dialog

Delete Controller

This button on the [Channel Configuration screen](#) brings up a list of the [controllers](#) used in the selected [track](#). Choosing one from the list will delete all of its [channels](#) from the track. If any of the channels had been shared with other tracks, it will *not* be removed from those other tracks.

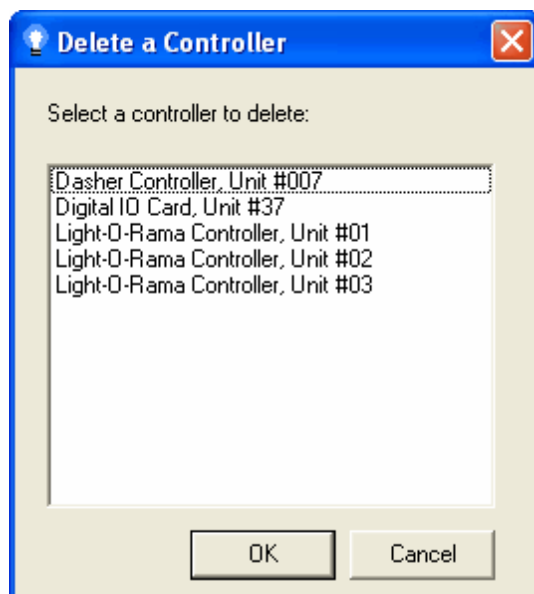

The Channel Configuration screen's "Delete Controller" dialog

Add Channels

This button on the [Channel Configuration screen](#) can be used to add many [channels](#) to the selected [track](#) all at once. You will be prompted for how many channels should be added.

The newly created channels will not have any of their properties (such as device type, unit ID and circuit ID) set. If you know in advance what these properties are to be, it would probably be easier to use "[Add Controller](#)" instead of "Add Channels".

5.3.15 The MIDI Wizard

The [Light-O-Rama Sequence Editor's MIDI Wizard](#) can be used to automatically populate a [musical sequence](#) that is based on a MIDI file with [timings](#) and [lighting effects](#) based on the MIDI file itself. For example, lights can be set up to chase each other in time to the music, or to turn on and off when certain notes are played.

The MIDI Wizard is available (for musical sequences based on MIDI files) as an option when [creating a new musical sequence](#) or a [new track](#), and can later be accessed via "[MIDI Wizard](#)" on the [Tools menu](#).

The MIDI Wizard has three main screens, each on a different tab:

The [Effects Summary tab](#) can be used to visualize the song while it is playing - for example, to see which instruments are playing what notes at what time, and to show the overall beat of the song. It can also be used to listen to only certain instruments in the song, by muting others. This tab cannot be used to insert timings or lighting effects into a sequence - instead, it is used to get an idea of how the other tabs might be used for the song.

The [Various Effects tab](#) can record timings and lighting effects based upon the beat of the song. The lights can be made to behave in a variety of ways, such as chasing each other or rotating around a tree, in various patterns.

The [Individual Notes tab](#) can be used to record timings and lighting effects based upon the notes played by individual instruments in the song. For example, a channel can be set up to turn on whenever a tenor saxophone plays a C note.

For more detailed help, please consult the help file pages for the individual tabs:

- The [Effects Summary tab](#)
- The [Various Effects tab](#)
- The [Individual Notes tab](#)

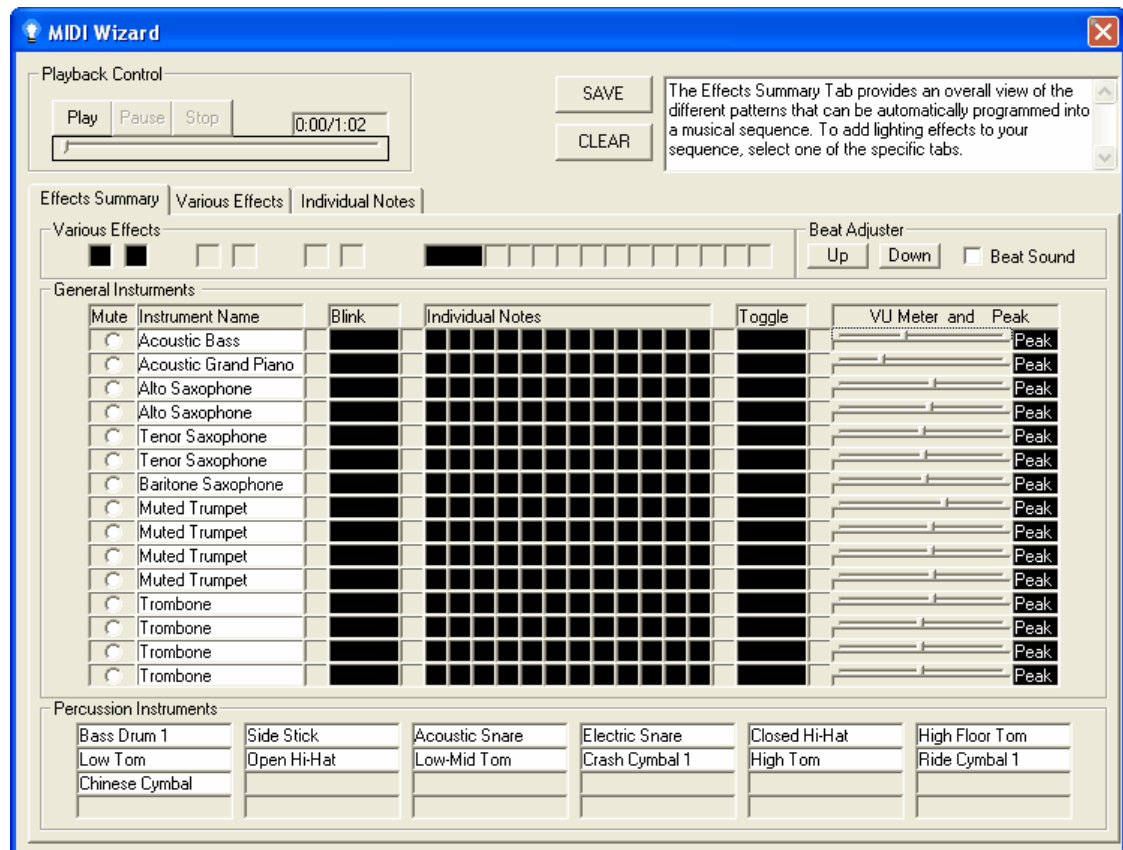

The MIDI Wizard's Effects Summary tab

5.3.15.1 The Effects Summary Tab

The [MIDI Wizard's](#) Effects Summary tab can be used to get an overall idea of a MIDI song. It displays, for example, which instrument is playing what note when, and the beat of the song. It can also mute instruments, so that you can listen more specifically to certain other instruments.

The Effects Summary tab cannot be used to insert [timings](#) or [lighting effects](#) into the [sequence](#). To do that, use the other tabs of the MIDI Wizard - the [Various Effects tab](#) and the [Individual Notes tab](#).

To use the Effects Summary tab, simply hit "Play". The song will begin playing, and the controls on the tab will start lighting up to represent what's happening in the song. The boxes in the "Various Effects" section will light up to represent the beat of the song; the "General Instruments" section will show which instruments are playing which notes when; the "Percussion Instruments" section will show which percussion instruments are playing at what times.

You can choose to mute certain instruments, by selecting the "Mute" radio button next to each, so as to listen more closely to other instruments.

You can also superimpose clicking beat sounds over the song, to more clearly hear where the beat is falling, by checking the "Beat Sound" checkbox in the "Beat Adjuster" section.

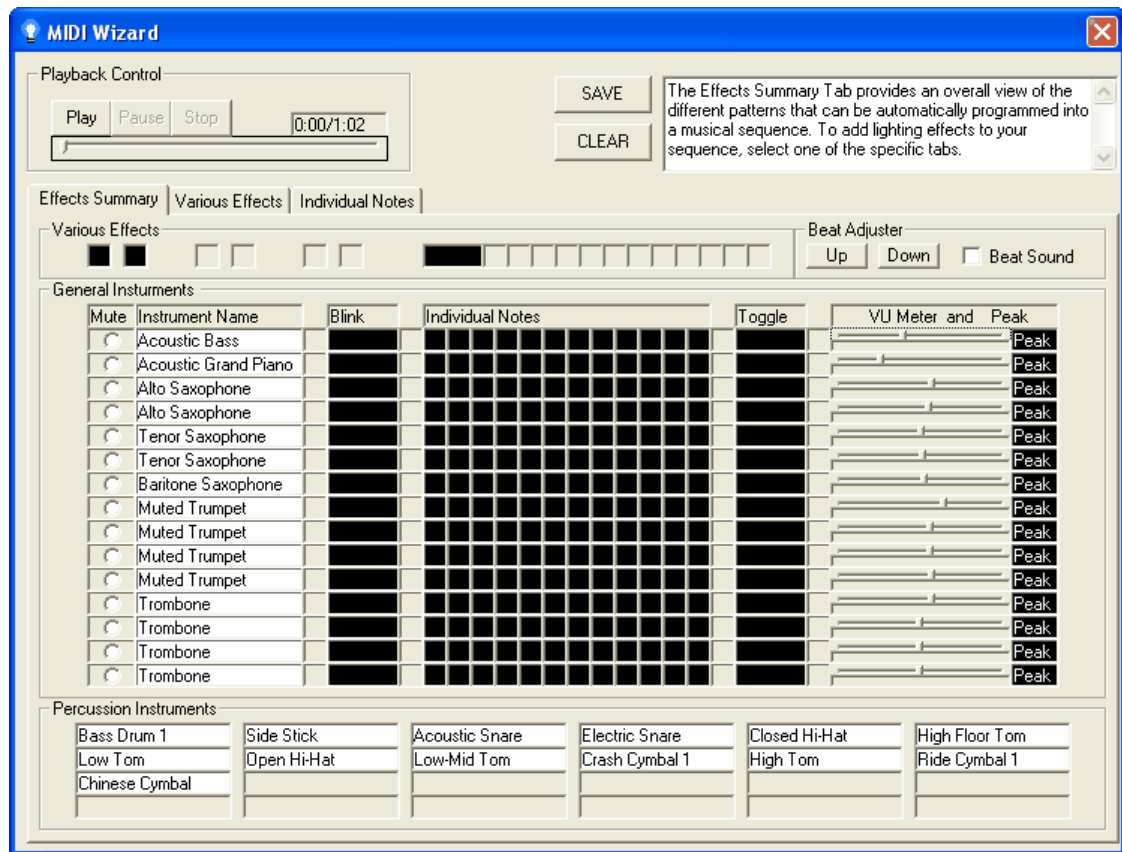

The MIDI Wizard's Effects Summary tab

5.3.15.2 The Various Effects Tab

The [MIDI Wizard's](#) Various Effects tab can be used to populate a [sequence](#) with [timings](#) and [lighting effects](#) based upon the beat of a MIDI file's song. For example, lights can be made to chase each other, in a variety of patterns, to the beat of the song.

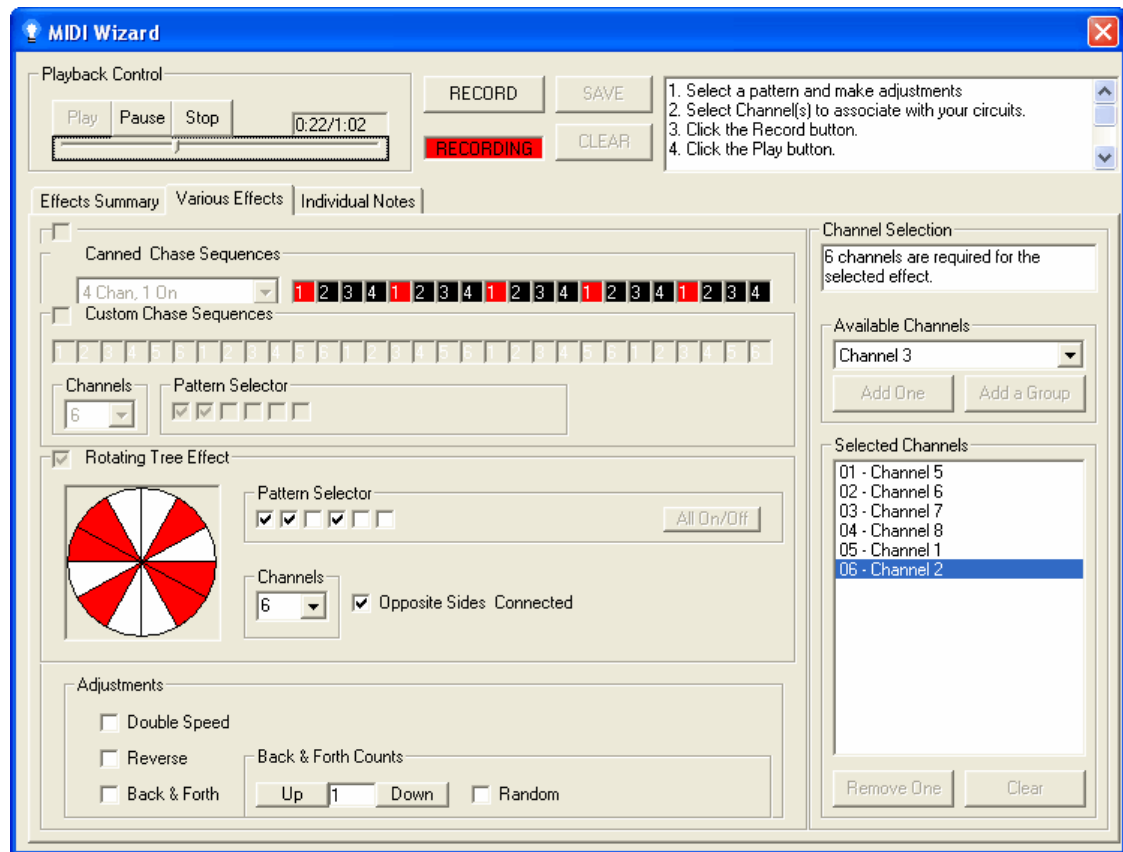

The MIDI Wizard's Various Effects tab, recording a rotating tree effect

There are three main types of effect patterns that can be made here:

- [Canned Chase Sequences](#)
- [Custom Chase Sequences](#)
- [Rotating Tree Effect](#)

There are two ways to use the tab - while recording effects and while not recording effects. By default, hitting "Play" will play the song, and let you choose patterns for the lights, but no effects will be recorded to be inserted into the sequence. This allows you to adjust the patterns to your liking before actually recording effects.

[Adjustments](#) can also be made while recording, but the main type of effect must be chosen before recording begins.

To play without recording, simply hit the "Play" button.

To record, first select the type of behavior you want to record (such as a canned chase sequence or a rotating tree effect). Choose the specific details of the behavior as well (for example, if you choose a canned chase sequence, also choose how many channels to use and how many of them should be on at any given time).

Next, select which [channels](#) from the sequence the effects will be recorded into, using the "Channel Selection" section (which is on the right). Each type of effect has a different number of channels required; you will not be allowed to record effects until the full number of required channels has been

assigned. You can select a channel from the dropdown list, and add it to the selected channels by pressing "Add One", or you can add several channels at once (starting with the selected channel) by pressing "Add a Group". At the bottom of the "Channel Selection" section are buttons enabling you to remove a channel from the selected channel list, or to clear the entire list.

Next, click the "Record" button. If you have not assigned the required number of channels, you will be told that you cannot record until you do so. If, however, you have, the "RECORDING" label (near the top) will turn red, and you can then hit "Play" to actually play the sequence and record effects.

During recording, you can make adjustments to the pattern, such as doubling its speed or reversing its direction, using the controls in the "Adjustments" section. These adjustments are done in real time, so, for example, you can record some of the pattern at normal speed, and then a minute into the song, switch the pattern to double speed; the events recorded in the first minute will still be at normal speed.

After play ends (either at the natural end of the song or by hitting "Stop"), hit "Record" again (at which point the red "RECORDING" label will turn off), and "Save" to save the recorded effects to the sequence. Or, if you were not satisfied with the recorded events, you can hit "Clear" to get rid of them.

Canned Chase Sequences

The Canned Chase Sequences section of the [MIDI Wizard's Various Effects tab](#) can be used to set up several [channels](#) of lights to chase each other - e.g. one turning on, then the next turning on while the first turns off, then another turning on while the second turns off, and so on.

Using the dropdown box in this section, you can choose how many channels will be involved in the chase, and how many of them will be on at any given time.

You can adjust the behavior of the chase - for example reversing its direction or speeding it up - using the controls in the [Adjustments](#) section. This can be done both before and during play, and before and during recording.

For more control over the behavior of a chase sequence - for example, to use more channels, or to use a different pattern for which channels are on at any given time - use [Custom Chase Sequences](#) instead.

Custom Chase Sequences

The Custom Chase Sequences section of the [MIDI Wizard's Various Effects tab](#) can be used to set up several [channels](#) of lights to chase each other - e.g. one turning on, then the next turning on while the first turns off, then another turning on while the second turns off, and so on. This is similar to the [Canned Chase Sequences](#) section, except that it is more flexible whereas the Canned Chase Sequences section is simpler to use.

In this section, you can select the number of [channels](#) involved in the chase, and, in the "Pattern Selector" section, choose how many channels will be on at any given time, and how far apart channels that are simultaneously on will be from each other.

You can adjust the behavior of the chase - for example reversing its direction or speeding it up - using the controls in the [Adjustments](#) section. This can be done both before and during play, and before and during recording.

Rotating Tree Effect

The Canned Chase Sequences section of the [MIDI Wizard's Various Effects tab](#) can be used to set up several [channels](#) of lights set up as vertical sections of a tree to rotate around the tree.

You can select how many channels to use, and then use the "Pattern Selector" section to define how many of them will be on at any given time, and how far apart simultaneously on channels will be.

The "Opposite Sides Connected" checkbox can be used to see how the lights will look if each single channel of lights is actually draped over the tree from one side to the opposite side, rather than each running down only one side of the tree.

You can adjust the behavior of the chase - for example reversing its direction or speeding it up - using the controls in the [Adjustments](#) section. This can be done both before and during play, and before and during recording.

Adjustments

The Adjustments section of the [MIDI Wizard's Various Effects tab](#) can be used to adjust the behavior of the selected effects pattern in various ways. This can be done both before and during play, and before and during recording.

Checking the "Double Speed" checkbox will cause the pattern to start going twice as fast as the beat of the song; unchecking it will bring the pattern back to its normal speed.

"Reverse" will make the pattern go in the opposite direction.

"Back & Forth" will cause the pattern to periodically reverse directions. Exactly how often it does so can be set using the "Back & Forth Counts" section.

5.3.15.3 The Individual Notes Tab

The [MIDI Wizard's](#) Individual Notes tab can be used to populate a [sequence](#) with [timings](#) and [lighting effects](#) based upon the notes that are played in a MIDI file's song. For example, lights can be made to flash whenever a trombone plays a G note.

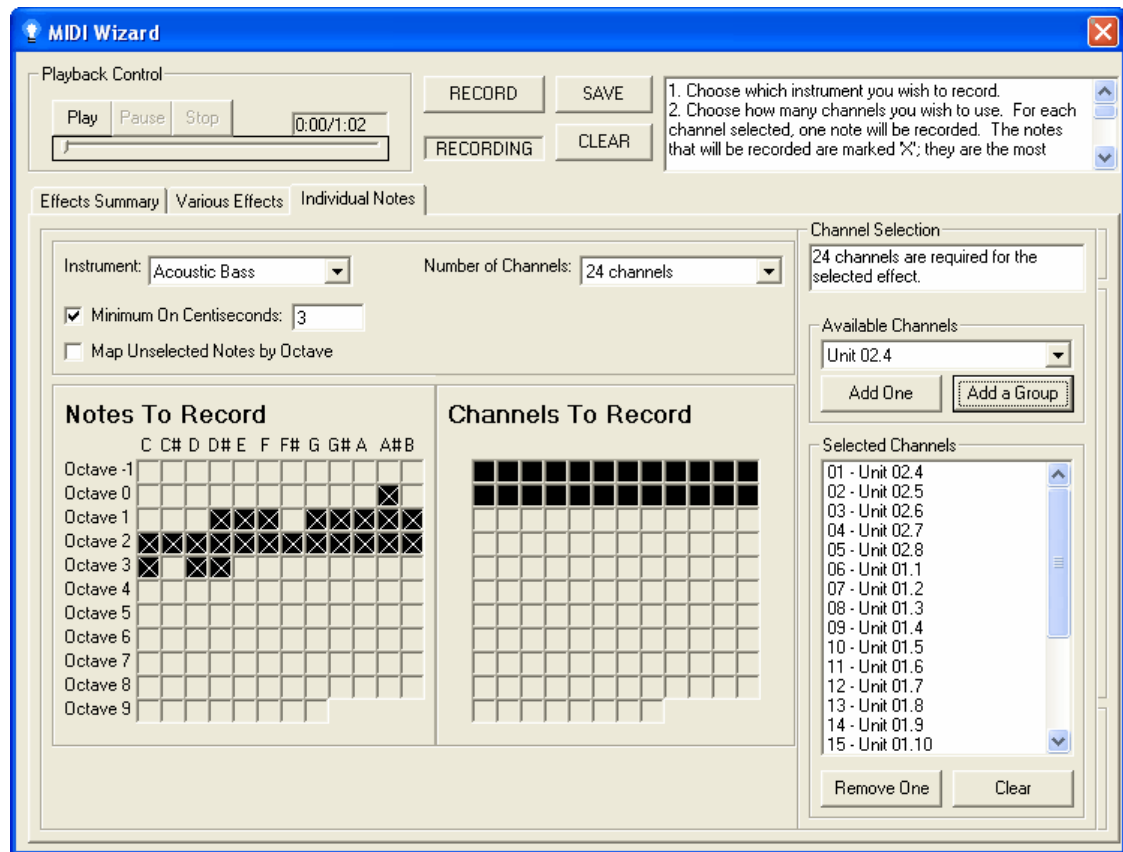

The MIDI Wizard's Individual Notes tab

There are two ways to use the tab - while recording effects and while not recording effects. By default, hitting "Play" will play the song, and let you choose patterns for the lights, but no effects will be recorded to be inserted into the sequence. This allows you to adjust the patterns to your liking before actually recording effects.

To play without recording, simply hit the "Play" button.

To record, first select the instrument that you wish to record. The notes that that instrument uses in the song will be displayed as black boxes in the "Notes To Record" section, with white X marks in them.

Next, select the number of channels that you wish to use for the recording. If you choose a number less than the full number of notes that the instrument uses in the song, some of the white X marks will go away; the same number will be left as the number of channels that you selected. Those white X marks indicate the notes that will actually be recorded - one note per channel. They are decided based upon how often each note is played by the instrument in the song; the most frequently used notes will be recorded.

Next, a couple of options can be selected, if you wish:

- Selecting "Minimum On Centiseconds" will force any channel that turns on to stay on for at least the specified duration. This prevents very fast notes from causing your lights to blink very quickly.
- "Map Unselected Notes by Octave" can be used to record notes of the same pitch class into a single channel. For example, if an instrument uses two or more different F-sharp notes (in different octaves)

during the song, and you have not specified enough channels to record them individually, then if a F-sharp that is not directly mapped to a channel is played, but another F-sharp is mapped to some channel, then that note will be recorded into the channel assigned to the closest F-sharp having a channel.

Next, select which [channels](#) from the sequence the notes will be recorded into, using the "Channel Selection" section (which is on the right). You will not be allowed to record effects until the full number of required channels (which you chose in the previous step) has been assigned. You can select a channel from the dropdown list, and add it to the selected channels by pressing "Add One", or you can add several channels at once (starting with the selected channel) by pressing "Add a Group". At the bottom of the "Channel Selection" section are buttons enabling you to remove a channel from the selected channel list, or to clear the entire list.

Next, click the "Record" button. If you have not assigned the required number of channels, you will be told that you cannot record until you do so. If, however, you have, the "RECORDING" label (near the top) will turn red, and you can then hit "Play" to actually play the sequence and record effects.

After play ends (either at the natural end of the song or by hitting "Stop"), hit "Record" again (at which point the red "RECORDING" label will turn off), and "Save" to save the recorded effects to the sequence. Or, if you were not satisfied with the recorded events, you can hit "Clear" to get rid of them.

5.3.16 The Tapper Wizard

The [Light-O-Rama Sequence Editor's](#) Tapper Wizard is a tool that lets you populate a [musical sequence](#) with [timings](#) and [lighting effects](#) simply by tapping along with the song, on your keyboard or your mouse. The Tapper Wizard will remember the moments in the song that you tapped at, and will insert timings and effects into the sequence at those times.

The Tapper Wizard is available as an option when [creating a new musical sequence](#) or a [new track](#), and can later be accessed via "[Tapper Wizard](#)" on the [Tools menu](#).

The Tapper Wizard has the following sections and controls:

- [Play Options](#)
- [What to Do with Taps](#)
- [Input Options](#)
- [Start and Stop](#)
- [Play Back](#)
- [Tap](#)
- [Apply](#)
- [Undo and Redo](#)
- [Apply and Exit](#)
- [Exit](#)

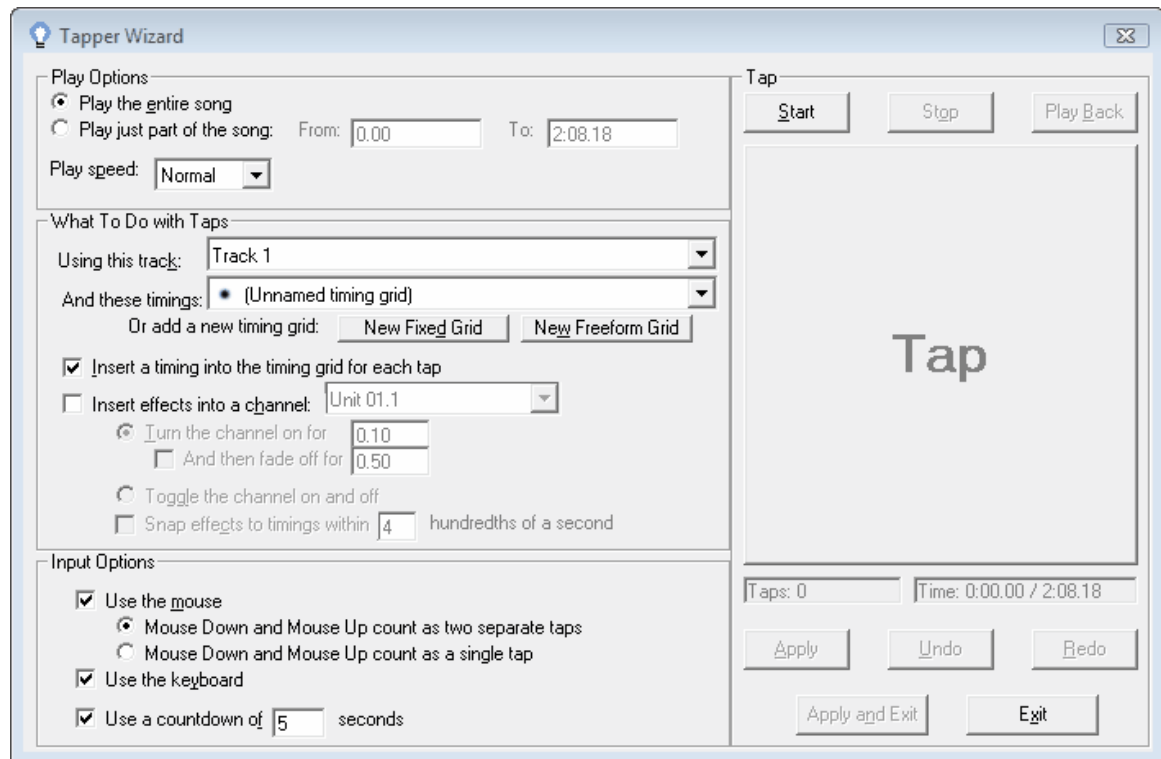

The Tapper Wizard

Play Options

This section of the [Tapper Wizard](#) lets you control how the song will be played while you are tapping. You can select to play the entire song, or just a certain time range of the song; you can also choose the speed at which the song will be played - half speed, normal speed, or double speed.

When the wizard is first opened, the time range will be automatically set depending upon "[Use Play Range for Wizards](#)" from the [Play Preferences dialog](#): If this option is enabled, the range will be set to the [freeform play range](#) if one exists, or the [play range](#) as set on the [Play menu](#) if not. If the option is not enabled, the range will be set to the entire song. One exception is when the wizard is opened directly from the [New Musical Sequence dialog](#); in this case, the range will be set to the entire song regardless of the value of "Use Play Range for Wizards".

What to Do with Taps

This section lets you tell the [Tapper Wizard](#) what you want it to do with your taps. You can choose the [track](#) and the [timing grid](#) to apply the taps to (or create a new timing grid to use), and then choose to insert [timings](#) into the timing grid, or to insert [lighting effects](#) into a [channel](#) of the track, or both.

If you choose to insert lighting effects into a channel, you can either have the channel briefly turn on for each tap, or you can choose to have it toggle on with one tap, off with the next, on with the third, and so forth. If you choose to have it turn briefly on for each tap, you can additionally choose to have it fade off after the tap (otherwise it will simply turn off).

You also have the option to "snap to existing events". If you select this option, and you tap at a

point in time that is near an existing timing (with "near" meaning within the number of hundredths of a second that you specify here), instead of using the exact time that you tapped, the Tapper Wizard uses the time of that timing. This makes it easier to cleanly use the Tapper Wizard multiple times on the same sequence (for different channels), without introducing minor timing errors based upon your reaction time.

After you have done your tapping, and used this section to tell the Tapper Wizard what to do with your taps, click "[Apply](#)", or "[Apply and Exit](#)" to apply them to the sequence. If you clicked "Apply" rather than "Apply and Exit", then the Tapper Wizard will remain open. At this point, you could change your settings in this section to apply your existing taps in a different way (such as to a different channel, or with different types of effects), or you could tap again (by hitting "[Start](#)" again) to collect new taps. You could also [undo and redo](#) any changes that the Tapper Wizard made to your sequence.

Input Options

This section of the [Tapper Wizard](#) allows you to control how you will tap.

You can use the mouse, or the keyboard, or both.

If you use the mouse, you have two options: pushing the mouse button down and then letting it up count as two separate taps, or as a single tap. To use the mouse, you must click on the [Tap](#) button.

If you use the keyboard, you can tap with practically any key, or even multiple keys.

You can also choose whether to use a countdown or not; if you do, then when you start the song (by clicking [Start](#)), a countdown will be displayed before the song begins, rather than starting immediately. This may give you time to get ready after clicking "Start".

Start and Stop

Use these buttons to start playing the song (or to start the countdown before play), and to stop the song. When the song begins, the [Tap](#) button will become enabled. When the song ends, you do not have to use the Stop button; the Stop button is for stopping the song in the middle, for example if you are unhappy with the taps that you made.

After the song ends (or after you hit Stop), you can click Start again in order to redo your taps. This will wipe out any previously recorded taps. You will be warned that they will be wiped out, and will be given an option to cancel.

You can also redo your taps after having [applied](#) them to the sequence. This lets you use different sets of taps for different purposes, all without closing the Tapper Wizard.

Tap

While a song is playing, the Tap button is enabled. Every time that you tap (whether by mouse or by keyboard), it will provide feedback by briefly flashing.

Play Back

After you have recorded taps, you can click "Play Back" to play the song over again. The [Tap button](#) will flash at the points in time that you tapped. You can use this to double check that you are satisfied with your taps before entering them into the [sequence](#) (by clicking the [Apply button](#)); if you are not satisfied with them, you can wipe them out and try again by hitting the [Start button](#) again.

Apply

After you have [tapped](#), and have told the [Tapper Wizard what to do with the taps](#), click the Apply button to apply those taps to your [sequence](#).

Note that you can then change the settings in the "What To Do with Taps" section, and click Apply again; this will apply the new settings, using the same taps, to the sequence.

Or, you could click [Start](#) again, to collect new taps. Your old taps will be deleted when you do this, but any [timings](#) or [effects](#) that you inserted into the sequence based on them will remain. In this way, you can use different sets of taps to do different things, all without closing the Tapper Wizard.

Undo and Redo

After applying your taps to the [sequence](#), you can use these buttons to undo and redo any such applications, without exiting from the [Tapper Wizard](#).

Apply and Exit

Clicking the [Tapper Wizard's](#) Apply and Exit button will apply your taps to the [sequence](#), in the manner that you specify in the "[What To Do with Taps](#)" section, and then exit from the Tapper Wizard.

If you want to apply your taps without exiting the Tapper Wizard, so that you can apply them again using new settings, or so that you can collect different taps, use the [Apply](#) button instead.

Exit

This button simply exits from the [Tapper Wizard](#), without applying your taps to the [sequence](#). Note, though, that if you have already applied your taps (using the [Apply](#) button), they will remain in your sequence; using this button (instead of [Apply and Exit](#)) will prevent your taps from being applied *again*.

For example, if you apply your taps, then change the settings in the [What To Do with Taps](#) section, and then click Exit, your applied taps, based on your original settings, will remain in the sequence, but your taps will not be reapplied based on the changed settings.

5.3.17 The VU Wizard

The [Light-O-Rama Sequence Editor's](#) VU Wizard can analyze the song associated with a [musical sequence](#) to try to find peaks in the audio - much like a VU meter - and can insert [timings](#) and [lighting effects](#) into the [sequence](#) based upon them.

The VU Wizard is available as an option when [creating a musical sequence](#) or a [new track](#), and can later be accessed via "[VU Wizard](#)" on the [Tools menu](#).

Not all types of media files are supported. For example, the VU Wizard cannot be used with video files or MIDI files. If the VU Wizard cannot be used with the media file for the sequence, it will simply be unavailable from this menu and these dialogs.

- [Selecting a Time Range](#)
- [Attack and Decay Settings](#)
- [The Peak Threshold](#)
- [Preview](#)
- [What To Do with Peaks](#)

VU Wizard

Time Range

The entire song (0:00.00 to 6:32.88)

Just part of the song:

From: 0:00.00 To: 6:32.88 Update

Attack and Decay

Attack: 65.2 milliseconds Update

Decay: 65.2 milliseconds

Presets: VU Meter Peak Program Meter Peak Meter

Peak Threshold

Time On: 54%

Total

Left

Right

Preview

Start Time: 0:00.00 / 6:32.88

What To Do with Peaks

Using this track: Track 1

And these timings: (Unnamed timing grid)

Or add a new timing grid: New Fixed Grid New Freeform Grid

Insert a timing into the track whenever the peak threshold is crossed

Turn a channel on when above the threshold, and off when below:

Unit 01.1

Snap effects to timings within 4 hundredths of a second

Apply and Exit Apply Exit Undo Redo

The VU Wizard

Selecting a Time Range

You can choose to let the [VU Wizard](#) look for audio peaks throughout the entire song, or limit it to a

specific portion of the song. If you choose to use only a portion of the song, be sure to hit the "Update" button after setting the "From" and "To" times.

When the wizard is first opened, the time range will be automatically set depending upon "[Use Play Range for Wizards](#)" from the [Play Preferences dialog](#): If this option is enabled, the range will be set to the [freiform play range](#) if one exists, or the [play range](#) as set on the [Play menu](#) if not. If the option is not enabled, the range will be set to the entire song. One exception is when the wizard is opened directly from the [New Musical Sequence dialog](#); in this case, the range will be set to the entire song regardless of the value of "Use Play Range for Wizards".

Attack and Decay Settings

These two values determine how quickly the [VU Wizard](#) will react to changes in the audio volume. "Attack" is how quickly it reacts to increased volume, and "Decay" is how quickly it reacts to decreased volume. The higher the number, the more slowly it reacts to changes.

You can enter specific numbers (make sure to hit "Update" if you do), or you can use one of the "Preset" buttons to simulate common types of audio meters:

- "VU Meter" simulates a standard VU meter, as often found on home stereo systems.
- A "Peak Program Meter" reacts very quickly to increased volume, but very slowly to decreased volume. This causes peaks to last longer.
- A "Peak Meter" reacts instantaneously to changes in volume.

Peak Threshold

Using the Peak Threshold section, you can tell the [VU Wizard](#) to look for audio peaks on either the left stereo channel or the right stereo channel, or on the sum of the two.

The selected stereo channel (or channels) has a thick black bar in its row. This bar represents the threshold for what will be considered a peak. Above the bar is a peak; below the bar is not. The bar can be slid left and right to increase and decrease the threshold.

The "Time On" percentage displayed in this section shows the percentage of the selected time range that is above the specified peak. Updating any of the settings such as the peak threshold, the [attack and decay](#), or the [time range](#) will cause the "Time On" percentage to be automatically updated as well, taking the new settings into account.

When you play the song (using the "[Preview](#)" section), the rows will pulse along with the audio volume, showing blue starting at the left and continuing rightwards based upon how loud the audio is at any given point in time. When the selected stereo channel (or channels) is above the threshold, it will turn red instead of blue.

Note that this is strongly affected by the attack and decay settings - lower values will cause the pulsing to react more slowly to the music, and higher values more quickly. Try playing with the various "Preset" buttons to see this.

Preview

Clicking the Start button in the [VU Wizard's Preview](#) section plays the song, and pulses the rows in the [Peak Threshold section](#) along with the audio. It also flashes the box in the Preview section whenever the pulse is above the selected threshold.

You can change both threshold settings and the [attack and decay settings](#) during preview, and the VU Wizard will react instantly to such changes. However, only the final settings will be used when you apply the peaks to the [sequence](#) (using the "[What To Do with Peaks](#)" section).

What To Do with Peaks

Once you are satisfied with the peaks found using your chosen [attack and decay settings](#) and [peak threshold settings](#), you can apply the peaks to the [sequence](#) using the "What To Do with Peaks" section of the [VU Wizard](#). You can insert a timing every time the threshold is crossed (no matter whether from below or from above), or turn a selected [channel](#) on whenever above the threshold, and off whenever below, or both.

You can reuse the VU Wizard for multiple channels (and multiple settings) without closing it by clicking "Apply" rather than "Apply and Exit".

5.3.18 Freeform Play Mode

In addition to the various [play ranges](#) available on the [play menu](#), the [Sequence Editor](#) also supports another way of playing a [sequence](#), using the space bar on the [keyboard](#).

When the space bar is pressed, the current sequence will start playing, starting at the start of the current selection and ending at the end of the sequence (this is equivalent to "[From Selection](#)" play mode). Pressing space again will stop play, and the selection will be changed to the spot where play stopped. So pressing it a third time will start the sequence again, approximately where you had stopped it. This can be used to effectively pause and un-pause play.

However, the space bar may have a different meaning, allowing play in another way:

During play, pressing the keyboard's down arrow will mark the current time as the start of a "freeform play range". Later pressing the up arrow will mark the current time as the end of the freeform play range. The freeform play range is displayed with a slightly darker grey background color for its cells:

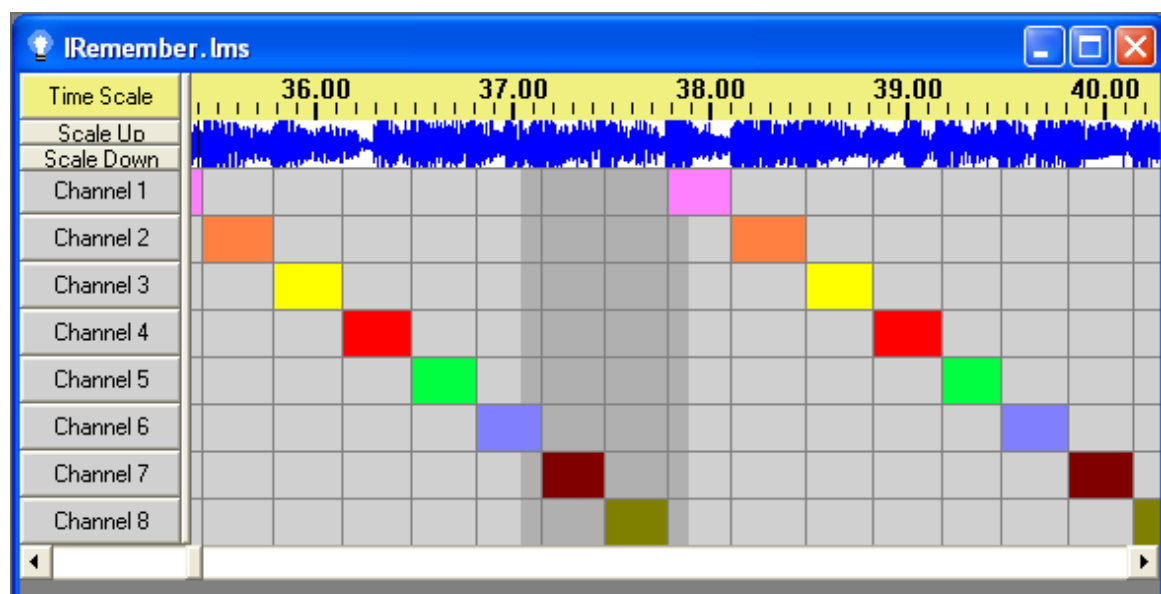

A sequence with a freeform play range starting at about 37 seconds

If the space bar is used to start play while a freeform play range has been selected, then instead of playing in "From Selection" mode (as described above), it will play from the start of the freeform play range to the end of it.

Using "shift-space" instead of "space" to start play will first get rid of any freeform play range that may be selected. The freeform play range can also be removed (without starting play) by selecting "[Clear Freeform Play Range](#)" from the [right-click context menu](#).

The freeform play range can also be selected (while not playing) by clicking and dragging the mouse on the time scale, or cleared by clicking (and not dragging).

Note that using the space bar to play does *not* affect the currently selected [play mode](#) from the [play menu](#), so playing in any other way (such as using the [Play button](#) on the [Standard toolbar](#)) will still use the last-selected play mode.

5.4 SuperStar Sequencer

The Light-O-Rama SuperStar Sequencer can be used as a sort of front end to the [Light-O-Rama Sequence Editor](#), to create sequences for Cosmic Color Ribbons or other lights visually instead of using a channels-versus-time grid. For more information, please see the following pages:

- [Welcome](#)
- [Overview](#)
- [Instant Sequences](#)
- [Custom Sequences](#)
- [Visualization Sequences](#)
- [Summary of Commands and Keyboard Accelerators](#)

5.4.1 Welcome

In the [SuperStar Sequencer](#), you can create:

- [Instant Sequences](#)
- [Custom Sequences](#)
- [Visualization Sequences](#)

Instant Sequences

Create sequences in seconds using the [Instant Sequence](#) feature by simply doing the following:

- Press Ctrl+I to launch the Instant Sequence dialog box; use the three buttons in the lower left of the dialog box.
- Click on the "Open Audio File" button to open your audio file.
- Click on the "Sequence All" button.
- Click on the "Play/Stop All" button.

Custom Sequences

Create [custom sequences](#) like the ones that can be seen on [the Light-O-Rama website](#). These sequences were created using scenes, morphs, images, and text actions, which you can learn

about in this help file.

Visualization Sequences

Using the [visualization sequences](#) feature, you can sequence all of your lights using the [SuperStar Sequencer](#). After creating a visualization file using the [Light-O-Rama Visualizer](#), you can import the file into SuperStar by clicking on the File menu and selecting "Import Visualization". Apply effects to your lights and play them back. You can even use the [Instant Sequence](#) feature on the visualization.

5.4.2 Overview

This page gives an overview of the [Light-O-Rama SuperStar Sequencer](#):

- [A new approach](#)
- [Exporting a sequence](#)
- [Playing an exported sequence as a standalone sequence](#)
- [Playing an exported sequence as a subsequence](#)
- [Placing an exported sequence into a main sequence using "Paint Sequence"](#)
- [Things to note](#)
 - [The Demo version](#)
 - [Default layout](#)
 - [PowerPoint presentations](#)

A New Approach

The [SuperStar Sequencer](#) is a new approach to light sequencing. Think of the SuperStar Sequencer as a "front end" to the [Light-O-Rama Sequence Editor](#). A series of effects are created and can be played to the computer screen, but to play the sequence to your Cosmic Color Ribbons or other lights, you export the SuperStar sequence to a file that the Sequence Editor can play.

If the exported file is from a [Visualization Sequence](#) and the SuperStar sequence contains all your lights, then you can play the file as a standalone sequence, simply by opening the exported file in the Light-O-Rama Sequence Editor and playing it.

If the exported file only contains the CCRs of the sequence, then the exported file can be played in one of three ways:

- [As a standalone sequence](#) (just load the file into the Sequence Editor and play it).
- [As a subsequence](#) in your main sequence.
- [Place the sequence into your main sequence using the "Paint Sequence" tool](#) in the Sequence Editor.

Exporting a Sequence

To export a sequence, click on the File menu and select "Export". The "Save as Light-O-Rama Sequence" dialog box will open. The default location will be the Light-O-Rama "Sequences" directory.

The default name of your Light-O-Rama sequence file will depend upon the name of your SuperStar sequence file. For example if the name of your SuperStar sequence file is "MyAwesomeSequence.sup", then the default name of your Light-O-Rama sequence file will be "MyAwesomeSequence.sup".

lms". You can change the name if you wish.

Click on the "Save" button to save the file.

Playing an Exported Sequence as a Standalone Sequence

Launch the [Light-O-Rama Sequence Editor](#). In the [New and Open dialog](#), click on the "[Existing Sequence](#)" tab. Select the file that you exported from the [SuperStar Sequencer](#) (in the [example given above](#), the exported file name was "MyAwesomeSequence.sup.lms"). Click on the "OK" button, and then click on the Sequence Editor's "[Play](#)" button.

Playing an Exported Sequence as a Subsequence

To use an exported [SuperStar](#) sequence as a [subsequence](#), launch the [Light-O-Rama Sequence Editor](#). Open your [sequence](#) that you want to put the exported sequence into as a subsequence. Insert a new [channel](#) into the sequence, and click on that [channel's button](#) to open up its [Channel Settings dialog](#).

Change the channel's device type to "Sequence", and then click on the "..." button (near the bottom, on the "Sequence" line) to select the file that you exported from SuperStar (in [the example above](#), "MyAwesomeSequence.sup.lms"). Also change the channel's name and color if you wish.

The subsequence will be played only while the grid boxes for this channel are on, so use the Sequence Editor's [On tool](#) to turn them on for the time range (or ranges) that you want. For example, to play the subsequence throughout the entire sequence, select the entire row, and apply the On tool to it.

The main sequence and the subsequence should not both try to control the same lights; it is recommended that any circuits referred to in the subsequence are removed from and kept out of the main sequence. Doing otherwise may cause unpredictable results.

Placing an Exported Sequence into a Main Sequence using "Paint Sequence"

To place an exported [SuperStar](#) sequence into a main [sequence](#) using the [Paint Sequence tool](#), launch the [Sequence Editor](#) and [open](#) your main sequence. Define the CCR [channels](#) in it. If you are using a sequence that has the 6 star channels in it, you will also need to define your star channels to be in a 16 channel controller that is above the CCR channels.

Select the Paint Sequence tool on the toolbar. It looks like a paintbrush on a rectangle. This will open the Paint Sequence dialog.

In the Paint Sequence dialog, make sure that the Mode is set to "Repeat", and click on the "Add New Sequence" button. Select the exported file (in the example above, "MyAwesomeSequence.sup.lms").

Scroll to the top left of the area where you are going to paint the sequence. The Paint Sequence dialog should still be visible; keep it visible while doing the next step. Start at the left end and select the entire top row of the region where you are going to paint the sequence. What happens is that all rows of the exported sequence get painted into the main sequence, starting at the row you selected. Because the exported sequences are usually very large, the painting of the sequence could take as

much as a minute or more.

Things To Note

- [The Demo version](#)
- [Default Layout](#)
- [PowerPoint Presentations](#)

The Demo Version

The Demo version of the [SuperStar Sequencer](#) will not export [sequences](#). However, all other functionality is the same as the [paid versions](#). You can sequence to any number of ribbons and save the sequence in the SuperStar format; you just can't export those SuperStar sequences to the [Sequence Editor](#).

Default Layout

The default layout is 12 Cosmic Color Ribbons (CCRs) with a star at the top. The star is optional, and the number of ribbons is configurable from 1 to 24. To change the configuration, click on the Tools menu and select "Configuration".

PowerPoint Presentations

There are PowerPoint presentations related to SuperStar which you can download from [the Light-O-Rama website](#).

5.4.3 Instant Sequences

Using the [Light-O-Rama SuperStar Sequencer](#), you can now create a [sequence](#) in seconds using the "Instant Sequence" feature. This is a first for the home light show industry.

- [Creating an instant sequence](#)
- [Timing map description](#)
- [Apply different sets of theme, color, and movement to different parts of the song](#)

Creating an Instant Sequence

Click on the Tools menu and select "Instant Sequence..." (or you can press Ctrl+I), which will open the Instant Sequence dialog. In the lower left of the Instant Sequence dialog, click on the "Open Audio File" button. Then click on the "Sequence All" button. The effects for a sequence will appear in the time layers. Click on the "Play/Stop All" button.

Was that totally awesome or what! The timing marks were created by analyzing the audio file. The sequence was created using the timing marks and the theme, color and movement variations that you see in the dialog box. Now let's create another sequence:

Click on the "Roll Dice" button to get a random set of theme, color, and movement variations. Click on the "Sequence All" button; it will ask you if you want to erase the current sequence without saving (answer "Yes"). Click on the "Play/Stop All" button.

After trying a few sequences, you can try manually changing the variations, but it's more fun to just roll the dice!

To increase or reduce the number of effects being created, you can change the sensitivity. Do this by clicking on the "Timing Map" button and changing the Sensitivity setting in the upper left of the Timing Map dialog box. Click on the "Sequence All" button in the "Instant Sequence" dialog box to create a new sequence using the new sensitivity setting.

The sensitivity setting may be the only setting that you ever change in the Timing Map dialog box, but if you are adventuresome and want to experiment with the other Timing Map settings, read [the next section](#).

Timing Map Description

Click on the "Timing Map" button in the [Instant Sequence](#) dialog box. A large dialog box entitled "Timing Map" will appear. This dialog box gives you control over the mapping of the frequency spectrum to the ribbons, which is how the timing marks get created:

- [Freq 1 through Freq 32](#)
- [Beat, Both, Left, Right](#)
- [Sensitivity](#)
- [Length of Effects](#)
- [Default Freq Settings](#)
- [Change the Timing Map](#)

Freq 1 through Freq 32

Note that there are check marks showing that Freq 1 and Freq 2 are mapped to Ribbon 1. Freq 3 and Freq 4 are mapped to Ribbon 2, and so on. On the right side of the dialog box is a piano keyboard which shows which notes the Freqs map to.

Beat, Both, Left, Right

The default setting is "Both", meaning both the left and right channels of the stereo sound will be used when creating effects. You can also set "Left" or "right" to use the left or right channel of the stereo sound. Click on "Beat" to use the beat when creating effects.

Sensitivity

Sensitivity can be set to values from 1 to 10. The default is 5. Setting to a higher number will create more effects. Setting to a lower number will create fewer effects.

Length of Effects

Length of Effects can be set to values from 1 to 10. The default is 5. Setting to a higher number will make some of the effects last longer. Setting to a lower number will make some of the effects shorter. You can also think of this as the "Ritalin" setting, in that a higher number will sedate hyperactive sequences and make them more mellow.

Default Freq Settings

There are seven default freq settings that you can use. For example, click on "Stereo Low to High" and then click on "Set Freq Spectrum", and you will see the check marks and radio buttons change in the timing map so that the left and right channels of the stereo sound are used.

You can choose to "Include Beat" in the generation of effects.

By default, "Set Theme, Color, and Movement" is selected, meaning that when you click on the "Set Freq Spectrum" it will also set some default values for the [Theme, Color, and Movement](#). If you want to keep the Theme, Color, and Movement settings that you have, then you would uncheck "Set Theme, Color, and Movement".

Change the Timing Map

In the "Default Freq Settings" area, click on "Stereo Low to High", and then click on "Set Freq Spectrum". Go back to the "Instant Sequence" dialog box and click on "Sequence All". It will ask you if you want to overwrite your existing timings; answer "Yes". It will ask you if you want to erase the existing sequence without saving; answer "Yes". Click on "Play/Stop All".

Notice that the ribbons on the left half have effects applied based on the left stereo channel, and the ribbons on the right half have effects applied based on the right stereo channel.

Apply Different Sets of Theme, Color and Movement to Different Parts of the Song

By default, you sequence the entire song each time you click on "Sequence All". To add more variation to your sequence, you can just do a portion of the song. To do this:

- Launch the "[Instant Sequence](#)" dialog box by pressing Ctrl+I.
- Near the top of the dialog box, click on the "Sequence the Selection Only" radio button.
- Use the Rewind or Forward buttons on the toolbar to scroll to the beginning of the region you want to sequence.
- Use a single left mouse click to mark the beginning of the region.
- Use the Forward or Fast Forward buttons on the toolbar to scroll to the end of the region you want to sequence.
- Use a single right mouse click to mark the end of the region.
- Before clearing the region, it is a good practice to click on "Unique Save As". This button is a quick way to save the current state of the sequence to a unique file name so that you can go back to it if you need to.
- If the region is not already cleared, click on "Clear Selection without Saving".
- Click on "Roll Dice", or set the theme, color, and move variations manually.
- Click on "Sequence Selection".

Note that "Clear Selection without Saving" uses the beginning of an effect to decide if it should be deleted. In other words, all effects whose start time falls within the selection region will be deleted.

5.4.4 Custom Sequences

What you won't see in the [Light-O-Rama SuperStar Sequencer](#) is the giant grid that the traditional [Sequence Editor](#) uses; instead, effects are added by:

1. Setting time ranges in the time scale.
2. Selecting squares in the Green Pixel grid (also referred to as the sequencing grid).
3. Using the Scenes, Morphs, Images, and Text dialog boxes in the Tools menu.

For more information, please refer to the following sections of this help file:

- [Creating a Scene](#)
- [Export](#)
- [Creating a Morph](#)
- [Creating an Image Action](#)
- [Creating an Animation](#)
- [Creating Text](#)
- [Transfer Effects from One Sequence to Another](#)
- [Load/Save Clipboard](#)
- [Change to 10 Pixels per Ribbon](#)
- ["Star Rays", "Wide Grid", and "Thin Grid"](#)
- [The Layout Dialog Box](#)
- [Balanced Color Mode / Full Color Mode](#)
- [Smooth Ramps](#)
- [Configure Controller Unit IDs Using the Light-O-Rama Hardware Utility](#)
- [Configure Controller Unit IDs in the SuperStar Sequencer](#)
- [Channelizer](#)
- [Select All, Select All Left, and Select All Right](#)
- [Importing a Timing Grid and up to 3 Timing Channels](#)

5.4.4.1 Creating a Scene

In the [Light-O-Rama SuperStar Sequencer](#), a "scene" is a set of pixels that have the same start color, the same end color, a start time, and an end time.

- [Initialize the Screen](#)
- [Launch the Scene Dialog Box](#)
- [Select Some Pixels in the Pixel Grid](#)
- [Add the Scene](#)
- [Play the Scene](#)
- [Create a Scene that Has an End Color](#)
- [Play the Scenes](#)
- [Change Some Settings](#)
- [Modify a Scene](#)
- [Play the Scenes Again](#)
- [Why Did the First Scene Go from Red to Purple to Blue?](#)
- [Undo and Redo Your Modification](#)
- [Group Select](#)
- [Group Modify](#)
- [Using Group Modify to Clone](#)
- [Pause and Freeze Frame](#)
- [Add Some More Scenes of Your Choosing](#)
- [Save the Scenes You Have Created](#)

Initialize the Screen

Click on the toolbar button with a piece of paper on it. This will do three things: It will clear the pixel grid, set the Start color as red, and set the time duration to 1.00-2.00 seconds.

Launch the Scene Dialog Box

Click on the Tools menu and select "Scenes". The Scene dialog box will launch. Whenever the scene dialog box is launched, the "Monochrome" mode is automatically selected and the toolbar button with a black and red rectangle will depress.

Select Some Pixels in the Pixel grid

While in "Monochrome" mode, you can color pixels in the pixel grid using the left mouse button. You can use single click or click and drag. You can erase pixels in the pixel grid using the right mouse button. Ctrl + right mouse button will erase the entire grid. Since the Start color is already set to red, the pixels will become red as you select them.

Add the Scene

In the Scene dialog box, click on the "Add" button to add the scene.

Play the Scene

Click on the play button in the toolbar (the button with a triangle pointing to the right). Note that at 1.00 seconds, the group of pixels you selected will turn red.

Create a Scene that Has an End Color

The default is for the "Start" and "End" color to both be red. Let's change that and create another scene:

- Set the start and end time to 2.00 to 3.00 seconds. You can select the time with the mouse by selecting a region in the time scale, or you can type into the fields in the dialog box.
- Color some pixels.
- The left red control is already at 100%; the selected pixels will turn red.
- Set the right red control to 0%; this represents the "End" color. When you set the "End" color it does not appear in the pixel grid, but it does appear as a number in the Scene dialog.
- Click on the "Add" button to add this scene.

Play the Scenes

Click on the Play button in the toolbar. At 1.00 seconds the first group of pixels will turn red and stay red. At 2.00 seconds, the second group of pixels will turn red and fade to black.

Change Some Settings

In the Scene dialog box, there is a list box listing the scenes you have added. They are listed chronologically by their start times. Select the first scene in the list. Note that the time, colors, and pixels for that scene appear in the main screen. The "End" color for this scene is black. Set 100% Blue for the end color. You can do this with the right Blue color control, or by manually typing 100 into the field in the Scene dialog box.

Note: Right click on the colored box above the color controls to bring up a "Color Picker" dialog.

Modify a Scene

Click on the "Modify" button. This will apply the new settings to the currently selected scene.

Play the Scenes Again

Click on the Play button. at 1.00 seconds, the pixels in the first scene will turn red, fade to purple, and then fade to blue by 2.00 seconds. At 2.00 - 3.00 seconds, the second scene will play, same as it did before.

Why Did the First Scene Go from Red to Purple to Blue?

You probably already figured this out: What you really did was set a red ramp that started at 100 and ended at 0. You also set a blue ramp that started at 0 and ended at 100. So in the middle, red was at 50 and blue was at 50, and the red and blue mix to make purple.

Undo and Redo Your Modification

Click on the Edit menu and select "Undo Scene Modify". Then click on the Edit menu and select "Redo Scene Modify".

If you do an Add, Modify, or Delete, and change your mind, you can undo your change. You can undo up to ten actions. After undoing up to ten actions, you can also redo them.

Group Select

There are two ways to use the mouse to select both of the scenes:

1. Click and hold the left mouse button and drag the selection rectangle to contain both of the scenes in the time layer area.
2. Click on the first scene to select it, then press and hold the Ctrl key while clicking on the second scene.

Group Modify

Set the start color to yellow, by setting 100% red and 100% green (red and green mix to make yellow). Click on "Group Modify" in the Scene dialog box. A popup box will appear, entitled "Scene Group Modify".

Because you changed the start color, "Modify Start Color" will already be selected. Click on "OK". Note that the start color of both the scenes has changed to yellow.

Using Group Modify to Clone

Click on "Group Modify" again; because you have not changed anything, none of the boxes are selected. However, you can select any or all of the checkboxes to clone the attributes of the first scene onto all the selected scenes. For example, select "Modify End Color", then click "OK". The End color will be cloned onto the second scene.

Group Modify is a very powerful tool that can save a lot of time as you fine tune a sequence. It allows you to change an attribute across an entire group of effects just to see how it looks. As with other features, you can undo and redo a group modify.

Pause and Freeze Frame

To the left of the stop button on the toolbars is the pause button. When you press the pause button,

a white line appears at the time selection point. While paused, the rewind and forward keys will step through the sequence in "freeze frame" manner. You can also click anywhere on the timeline to reposition the location of the freeze frame. This is very useful while developing sequences, to better see what each frame of the sequence will look like.

Unpause by clicking on the pause button again, or by clicking on the stop button.

Add Some More Scenes of Your Choosing

Go ahead and add some more scenes and play with the different settings. The times of the scenes can overlap. However, scenes that share the same time period should not share the same pixels. This creates a "pixel collision", and currently the results are not predictable (in the future, the SuperStar Sequencer will detect and prevent collisions).

Save the Scenes You Have Created

Click on the File menu and select "Save As". Save the scenes you have created as a file named "MyScenes.sup".

5.4.4.2 Export

If you are running the Demo version of the [Light-O-Rama SuperStar Sequencer](#), then Export will not work, but you may want to read through this section just to see how it works in the [full version](#).

The SuperStar Sequencer stores the effects in ".sup" files, but the effects can be exported as ".lms" or ".las" files so that the [Light-O-Rama Sequence Editor](#) can read and play them.

- [Initialize the screen](#)
- [Launch the Scene dialog box](#)
- [Create a scene using the first pixel of the first ribbon](#)
- [Save as an .sup file](#)
- [Export as an animation sequence](#)
- [Open the animation sequence with the Sequence Editor](#)
- [Load the file as a subsequence in the Sequence Editor](#)
- [Discussion](#)

Initialize the screen

Click on the toolbar button with a piece of paper on it. This will do three things: It will clear the pixel grid, set the start color as red, and set the time duration to 1.00-2.00 seconds.

Launch the Scene dialog box

Click on the Tools menu and select "Scenes". The Scene dialog box will launch.

Create a scene using the first pixel of the first ribbon

Click on the upper left pixel of the pixel grid, then click on the "Add" button in the Scene dialog box.

Save as an .sup file

Click on the File menu, then click on "Save As". In the Save As dialog box, type "OnePixel". Click on the Save button, and the effect will be saved as OnePixel.sup.

Export as an animation sequence

Click on the File menu, and then click on Export. If you are running the Demo version, you will get an error box saying that Export is not available, but if you are running the full version, the "Save as Light-O-Rama Animation Sequence" dialog box will appear. The name of the file will default to "OnePixel.sup.las"; click on the Save button, and the file will be saved in the Light-O-Rama Sequences directory.

Open the animation sequence with the Sequence Editor

Launch the [Light-O-Rama Sequence Editor](#) and open the file "OnePixel.sup.las". On the left side, the first 16 [channel buttons](#) will be labelled "Star 01" through "Star 16". The 17th button will be labelled "CCR01-P01-Red", and on this row there will be a fade from 1.00 to 2.00 seconds. Note that "CCR01" means "Ribbon 1", and "P01" means "Pixel 1".

Also note that with a star and 12 ribbons there are 1936 channels in the Sequence Editor. Imagine trying to sequence 12 ribbons using this huge grid! The SuperStar Sequencer makes it so that you do not have to deal with this grid.

Load the file as a subsequence in the Sequence Editor

- Close the "OnePixel.sup.las" file in the [Sequence Editor](#).
- Open any existing [animation sequence](#) or [musical sequence](#) that you already have.
- Right click on the first [channel button](#) at the top of your sequence.
- In the [popup menu](#), select "[Insert Channel Above](#)".
- Right click on the "New Channel" button that you just inserted.
- In the popup menu, select "[Change Channel Settings](#)"; the [Channel Settings dialog box](#) will appear.
- Change the name of the [channel](#) to something like "SuperStar".
- In the "Device Type" dropdown list, select "Sequence".
- On the "Sequence" line (near the bottom of the dialog), click on the "..." button. The "Open" dialog box will appear.
- Select the file "OnePixel.sup.las", and click on the "Open" button.
- Click on the "OK" button in the Channel Settings dialog box.

You are not done yet! The [subsequence](#) will only be played while the grid boxes for this channel are on. So, you want to set the grid boxes on for the entire row, all the way to the end of the sequence. To do this:

- Select one of the boxes on the row. Click on the [Edit menu](#), hover over [Select](#), and a flyout menu will appear. On the flyout menu click on "Row(s)". This will select the entire row.
- Right click on one of the boxes in the row, and select "[On](#)" from [the popup menu](#). This will turn the entire row on.

Now when you play your sequence, the subsequence will be played at the same time.

The main sequence and the subsequence should not both try to control the same lights; it is recommended that any circuits referred to in the subsequence are removed from and kept out of the main sequence. Doing otherwise may cause unpredictable results.

Discussion

The file extension ".lms" stands for "Light-O-Rama Musical Sequence", and ".las" stands for "Light-O-Rama Animation Sequence". The file in the exercise was saved as an [animation sequence](#) because there was no music file loaded. If you opened a song file for "OnePixel.sup", it would have been exported as a [musical sequence](#) ("OnePixel.sup.lms") instead of an animation sequence ("OnePixel.sup.las").

In the exercise, we used the default name of "OnePixel.sup.las". However, you could name it anything you want, so long as it ends with ".las" or ".lms". For example, you could call it "OnePixel.lms" or "FromSuperStar.lms". But the idea is that if you already have a musical sequence for your other lights, called "MyAwesomeSequence.lms", and you want to incorporate your Cosmic Color Ribbons as a part of that same show, then in the [SuperStar Sequencer](#) you could call it "MyAwesomeSequence.sup", and when it gets exported it will be called "MyAwesomeSequence.sup.lms". Thus it would be clear that it is an .lms file exported from an .sup file.

It is expected that MyAwesomeSequence.lms and MyAwesomeSequence.sup.lms both use the same music file and both are of the same length. However, if MyAwesomeSequence.sup.lms were shorter than the main sequence, and the [channel](#) assigned to the [subsequence](#) were on for the entire length of the main [sequence](#), then the subsequence will loop and start playing over.

5.4.4.3 Creating a Morph

In the [Light-O-Rama SuperStar Sequencer](#), a "Morph" consists of the following:

- Layer: Defines priority if there are collisions (future)
- Acceleration: The morph can accelerate as it goes from "State 1" to "State 2"

State 1 and State 2 each consist of:

1. Start point and end point of a line
2. Color
3. Time
4. Trail length

Ramp consists of:

1. Start color
2. End color
3. Time length

Here is an example of how to create a morph:

- [Get a new screen](#)
- [Launch the Morph dialog box](#)
- [Observe the default settings](#)
- [Add first morph](#)
- [Play the morph](#)
- [Set a simple morph with a different start and end color](#)
- [Modify the morph](#)

- [Play the morph](#)
- [Add a trail length](#)
- [Modify the current morph](#)
- [Play the morph again](#)
- [Change the State 1 line to a vertical line](#)
- [Change the State 2 line to a vertical line](#)
- [Set color of the State 2 line to 100% green](#)
- [Set the time to 2.00 to 3.00](#)
- [Add a second morph](#)
- [Play the morph](#)
- [The morph twist](#)
- [Save your morph](#)
- [Morph summary](#)
- [The length of a morph](#)

Get a new screen

Click on the toolbar button that has a picture of a piece of paper on it.

Launch the Morph dialog box

Click on the Tools menu and select Morph. The Morph dialog box will launch, and the Scene dialog box will automatically be shut down. Whenever the Morph dialog box is launched, the "Morph" mode is automatically selected, and the black toolbar button with horizontal lines on it will be depressed.

Observe the default settings

By default, a red line for State 1 will be at the top of the pixel grid, and a red line for State 2 will be at the bottom of the pixel grid. The time duration will be 1.00 to 2.00 seconds. The trailing ramp start color will be red, and the time length will be 1.00 seconds.

Add first morph

Press the "Add" button to add the morph.

Play the morph

On the toolbar, press the Play button. At 1.00 seconds, a red line will start from the top and go down to the bottom, leaving a trail that fades to black in one second.

Set a simple morph with a different start and end color

Leave the start color at red. Set the end color to blue. Set the Trailing Ramp Time length to 0.00.

Modify the morph

Press the "Modify" button to modify the selected morph.

Play the morph

On the toolbar, press the Play button. At 1.00 seconds, a red line will start from the top and go down to the bottom. The line will change from red to purple and then to blue by the time it reaches the bottom at 2.00 seconds.

Add a trail length

The trail length defaults to 1. Make the morph leave a trail by typing in a number in the Trail Length field. For this exercise, change the State 1 Trail Length to 2, and change the State 2 Trail Length to 10.

Modify the current morph

Click on the "Modify" button. This applies your changes to the currently selected morph in the morph list.

Play the morph again

This time, the morph will leave a trail of two lines at the top, and will change to leaving a trail of 10 lines at the bottom.

Change the State 1 line to a vertical line

The State 1 line is defined using a click and drag with the left mouse button. Note that one end of the State 1 line is labeled "1a" and the other end is labeled "1b". The start of the mouse drag will be "1a" and the end will be "1b". Make a vertical line by dragging on the left side of the pixel grid. Make your selection from top to bottom. When you are done, the top of the line should be labeled "1a", and the bottom of the line should be labeled "1b".

Change the State 2 line to a vertical line

The State 2 line is defined using a click and drag with the right mouse button. Note that one end of the State 2 line is labeled "2a" and the other end is labeled "2b". The start of the mouse drag will be "2a" and the end of the drag will be "2b". Make a vertical line by dragging on the right side of the pixel grid. Make your selection from top to bottom. When you are done, the top of the line should be labeled "2a" and the bottom of the line should be labeled "2b".

Set color of the State 2 line to 100% green

The color of the State 2 line is controlled by the right color controls. Set the right Blue control to 0% and the right Green control to 100%. This will change the State 2 line color from blue to green.

Set the time to 2.00 to 3.00

You can do this with the mouse on the time scale, or you can type the values into the dialog box. State 1 time is the start time, and State 2 time is the end time.

Add a second morph

Press the "Add" button to add the second morph.

Play the morph

On the toolbar, press the Play button. At 1.00 seconds, the first morph will play as it did before. At 2.00 seconds, the second morph will start from the left and end at the right.

The morph twist

Set the Trailing Ramp Time Length back to 1.00 seconds. The Trailing Ramp start color should be 100% red. Redefine the State 1 line by doing a mouse drag from bottom to top. Now "1a" will be on the bottom, and "1b" will be on the top. Click on the "Modify" button. Play the morph.

This time, the line will twist as it travels across. The effect will be that the line will become shorter in the middle and then get bigger. This is because as the morph progresses, point "1a" moves to point "2a", and point "1b" moves to point "2b".

Save your morph

Click on the File menu and select "Save As". Save the morphs you have created as a file named "MyMorphs.sup". Note that files can contain any combination of scenes and morphs. In this example, you saved them separately, but you could have saved your scenes and morphs together into a file of any name you choose.

Morph summary

Are morphs cool or what? You can do a lot with morphs. In the exercise, we morphed between two horizontal lines and between two vertical lines. You can also morph between diagonal lines.

Trail Length and Ramp can end up giving similar effects, but are applied differently. Trail Length leaves a trail that is a certain number of units long. Ramp is applied after the Trail effect, and is on for a fixed period of time. Experiment with different Trail and Ramp settings to get a feel for how they work.

The length of a morph

Most people won't care about the details of the total length of a morph. But for those that really want to know, there are three parts to a morph:

1. **Root:** This is the time for the leading edge of the morph to travel from State 1 to State 2.
2. **Trail Length:** The State 2 Trail Length will add the length of the trail at the end of the morph. This trail will take some time to travel past the end location of the morph. State 2 Trail Length includes the leading pixel, so State 2 Trail Length of 1 really ends up creating a trail of 0. For a Trail Length to be as long as the Root, the State 2 Trail Length should be 1 longer than the length of the morph. For example, if the morph goes the entire length of 50 pixels on the ribbon, then a State 2 Trail Length of 51 will double the time length of the morph.
3. **Ramp Length:** The ramp length is in seconds, and is applied after the Root and Trail.

The length of the Trail and the Ramp are displayed on the timeline as a narrow rectangle. Note that only the root can be selected. Clicking on the trail or the ramp will not do anything.

5.4.4.4 Creating an Image Action

In the [Light-O-Rama SuperStar Sequencer](#), an "image action" will move an image from a start point to an end point. At the end, a ramp can be applied. An image action consists of:

- Layer: Defines priority if there are collisions (future)
- Acceleration: The image can accelerate or decelerate as it goes from point A to point B (future)
- Image: A bitmap
- Start point
- End point
- Ramp

Ramp consists of:

- Time length
- Start color (future)
- End color (future)

Here is an example of how to create an image action:

- [Get a new screen](#)
- [Launch the Image Action dialog box](#)
- [Observe the default settings](#)
- [Draw an image](#)
- [Add an image name](#)
- [Add the image](#)
- [Observe the default image action values](#)
- [Type an image action name](#)
- [Add the image action](#)
- [Play the image action](#)
- [Add another image action](#)
- [Play the image actions](#)
- [Stop at the right edge](#)
- [View the image actions on a square grid](#)
- [Play it again](#)

Get a new screen

Click on the toolbar button that has a picture of a piece of paper on it.

Launch the Image Action dialog box

Click on the Tools menu and select "Images". The Image Action dialog box will launch, and the Morph dialog box will automatically be shut down. Whenever the Image Action dialog box is launched, the "Draw" mode is automatically selected and the toolbar button with a pencil on it will be depressed.

Observe the default settings

By default, the left red color control will be set to 100%. The time duration will be 1.00 to 2.00 seconds. All pixels in the pixel grid will be black.

Draw an image

Leave the left red color control at 100%. Set the left green color control to 100%. The start color will now be yellow. When drawing an image, only the start color is used; the end color is not used.

Click on the pixel grid to draw a smiley face at the top of the pixel grid. Single clicks will draw one pixel; click and drag will leave a trail of pixels. Right click erases pixels. Ctrl-right click will clear the entire grid.

Add an image name

At the top of the dialog box is the Image group. In the "Name" field of the Image group area, type "Smiley Face".

Add the image

In the Image group at the top of the dialog box, click on the Image "Add" button.

Observe the default image action values

The default start point (x,y) is (0,0), and the default end point (x,y) is (0,50). The default start and end times are 1.00 and 2.00. Leave these settings at their default values.

Type an image action name

In the Image Action group at the bottom of the dialog box, type "Smiley down".

Add the image action

In the Image Action group at the bottom of the dialog box, click on the Image Group "Add" button.

Play the image action

Play the image action. at 1.00 seconds, your image will start from the top and travel downward, disappearing off the bottom of the ribbons.

Add another image action

We will use the same image again, and this time move it horizontally.

For the time, select 2.00 to 3.00. For the start point, type (-12, 10) (enter minus twelve so that the start point and end point are different). For the end point, type (12, 10). For the Image Action name, type "Smiley right" in the bottom name field. Click on the bottom "Add" button.

Play the image actions

At 1.00 to 2.00 you will see the first image action, which goes from top to bottom. At 2.00 to 3.00, the second image action will move from left to right across the ribbons.

Stop at the right edge

Select the image action that goes from left to right. Keep the start point at (-12, 10), but change the end point to (0, 10). At the bottom of the dialog box, enter a "Ramp Time" of 1.00. Click the Modify button.

Play the image actions and you will see the first image action go from top to bottom. The second image action will move from the left to the right edge and then be displayed for 1.00 seconds at the right edge.

Note that the "Ramp Time" causes each pixel of the image to be displayed at full intensity, so if you draw pixels of low intensity in the image, then they will get brighter when they hit the edge.

View the image actions on a square grid

At the right end of the toolbar are three buttons. If you hover the mouse over the buttons you will see they are called "[Star Rays](#)", "[Wide Grid](#)", and "[Thin Grid](#)". Currently the "Star Rays" button is pressed. Click on the "Wide Grid" button.

Play it again

Play the image actions again and you will see how they look when the ribbons are parallel to each other and form a grid of pixels.

5.4.4.5 Creating an Animation

Using the [Light-O-Rama SuperStar Sequencer](#), you can create an animation using a series of stationary images. Here is an example of how to create an animation:

- [Load some pre-drawn images](#)
- [Launch the Image dialog box](#)
- [Select "Apply x,y in Preview \(for animations\)"](#)
- [Add the first image](#)
- [Add the second image](#)
- [Add the third image](#)
- [Add the fourth image](#)
- [What are those boxes under the timeline?](#)
- [Check your work](#)
- [How does cut/copy/paste work?](#)
- [Copy/paste four images](#)
- [Image group modify](#)
- [Copy/paste 8 images](#)
- [Image group modify](#)
- [Copy/paste 16 images](#)
- [Image group modify](#)
- [Copy/paste 13 images](#)
- [Image group modify](#)
- [Play the animation](#)
- [Nudge the animation to the left](#)
- [Play on "Wide grid" and "Narrow Grid"](#)
- [Save your animation](#)

- [Add an eye to Pac Man](#)
- [Play it again, Sam](#)

Load some pre-drawn images

Click on the File menu, select "Open...", and open the file "PacManImages.sup", located in the "Samples" directory of your SuperStar Sequences directory. Be sure to load PacManImages.sup, *not* PacManAnimation.sup.

Launch the Image dialog box

Click on the Tools menu and select "Images...". Click on each image in the image list box to view them.

Select "Apply x,y in Preview (for animations)"

Select the checkbox labeled "Apply x,y in Preview (for animations)". This applies the (x,y) coordinate in the preview of the image and it also disables the "End x" and "End y" edit fields (for animation images, the start (x,y) and end (x,y) are the same).

Add the first image

- In the image list box, select "01 Circle".
- In the Time Line, select from 1.00 to 1.10 seconds.
- In the Image Action x,y Start, type "0" and "44"
- In the Image Action name field, type "Mouth shut".
- In the Image Action section, click the "Add" button.

"1.00 Mouth shut" should appear in the Image Action list box.

Remember: If you make a mistake, you can always undo your mistake by clicking on the Edit menu and selecting Undo.

Add the second image

- In the image list box, select "02 Half open".
- In the timeline, select from 1.10 to 1.20 seconds.
- In the Image Action x,y Start, type "0" and "42".
- In the Image Action name field, type "Mouth half open".
- In the Image Action section, click the "Add" button.

"1.10 Mouth half open" should appear in the Image Action list box.

Add the third image

- In the image list box, select "03 Full open".
- In the timeline, select from 1.20 to 1.30 seconds.
- In the Image Action x,y Start, type "0" and "40".
- In the Image Action name field, type "Mouth full open".
- In the Image Action section, click the "Add" button.

"1.20 Mouth full open" should appear in the Image Action list box.

Add the fourth image

- In the image list box, select "02 Half open".
- In the timeline, select from 1.30 to 1.40 seconds.
- In the Image Action x,y Start, type "0" and "38".
- In the Image Action name field, type "Mouth half shut".
- In the Image Action section, click the "Add" button.

"1.30 Mouth half shut" should appear in the Image Action list box.

What are those boxes under the timeline?

Under the yellow timeline, you should see four light gray boxes. These boxes are the four image actions you just added. Click on the first of the four boxes and it will highlight the first image action, labeled "Mouth shut". Click on the second and it will highlight the second image action, "Mouth half open". You can also highlight the image action in the list box, and it will highlight the corresponding box under the timeline.

Check your work

It is easy to make a mistake while adding the image actions. Click on the first image action, labeled "Mouth shut", in the image action list box. Use the down arrow key to step through the image actions. The y coordinate should step through 44, 42, 40, and 38, and the top of the image should step up two pixels each time. If the image is not moving, make sure you have "Apply x,y in Preview (for animations)" selected.

How does cut/copy/paste work?

The fourth, fifth, and sixth buttons on the toolbar are the Cut, Copy, and Paste buttons. By default, the objects you paste will be placed in the first open layer, so that effects do not end up on top of each other. If you wish the pasted objects to stay in their original layers, press the Shift key while clicking on the Paste button.

Copy/paste four images

- Select all four of the light gray boxes under the yellow timeline.
- Click on the "Copy" toolbar button. The selected effects will be copied to the clipboard.
- Click on the timeline just after the light gray boxes, which will be at 1.40 seconds.
- Click on the Paste toolbar button. The effects in the clipboard will be pasted starting at 1.40 seconds.

Remember, if you make a mistake you can click on the Edit menu and select Undo.

Image group modify

- You should now have eight image actions on the timeline. Select the last four.
- Click on "Group Modify"; the Image Group Modify dialog box should appear.
- Select "Modify x,y".
- "Add as Offsets to x,y Positions" should already be selected; leave it selected.

- Underneath "Start", type "0" into the left field, and type "-8" into the second field. Click on "OK". This will subtract 8 from the y coordinate in the selected image actions.
- Click on each of the image actions, and you should see your animation move up the screen.

Copy/paste 8 images

Select all of the eight light gray boxes that you now have under the timeline. Click on the timeline just after the boxes that are already there. Click on Copy, and then Click on Paste.

Image group modify

- You should now have 16 image actions on the timeline. Select the last eight.
- Click on "Group Modify"; the Image Group Modify dialog box should appear.
- Select "Modify x,y".
- "Add as Offsets to x,y Positions" should already be selected; leave it selected.
- Underneath "Start", type "0" into the left field, and type "-16" into the second field. Click on "OK". This will subtract 16 from the y coordinate in the selected image actions.
- Click on each of the image actions, and you should see your animation move up the screen.

Copy/paste 16 images

Select all of the 16 light gray boxes that you now have under the timeline. Click on the timeline just after the boxes that are already there. Click on Copy, and then Click on Paste.

Image group modify

- You should now have 32 image actions on the timeline. Select the last 16.
- Click on "Group Modify"; the Image Group Modify dialog box should appear.
- Select "Modify x,y".
- "Add as Offsets to x,y Positions" should already be selected; leave it selected.
- Underneath "Start", type "0" into the left field, and type "-32" into the second field. Click on "OK". This will subtract 32 from the y coordinate in the selected image actions.
- Click on each of the image actions, and you should see your animation move up the screen.

Copy/paste 13 images

Select the first 13 light gray boxes that you now have under the timeline. Click on the timeline just after the boxes that are already there. Click on Copy, and then Click on Paste.

Image group modify

- You should now have 45 image actions on the timeline. Select the last 13.
- Click on "Group Modify"; the Image Group Modify dialog box should appear.
- Select "Modify x,y".
- "Add as Offsets to x,y Positions" should already be selected; leave it selected.
- Underneath "Start", type "0" into the left field, and type "-64" into the second field. Click on "OK". This will subtract 64 from the y coordinate in the selected image actions.
- Click on each of the image actions, and you should see your animation move up the screen.

Your animation is now complete.

Play the animation

Click on the Play button. You should see Pac Man chase the red ghost up the ribbons.

Nudge the animation to the left

The chomping sound starts before you see the animation start. To synchronize the appearance of the animation with the start of the chomping sound, select all of the image actions under the timeline. Click on the "Nudge Left" toolbar button (the button with an hourglass and a left arrow on it). All the image actions should move left by 0.05 seconds. Nudge left three or four more times and the animation should be more in sync with the sound.

Play on "Wide Grid" and "Narrow Grid"

Click on the "Wide Grid" toolbar button and play the animation.

Click on the "Narrow Grid" toolbar button and play the animation.

Save your animation

Click on the file menu, and select "Save As...". Save the file as "MyPacManAnimation.sup".

Note: There is already a file named PacManAnimation.sup in the Samples directory. You can compare your animation with this animation.

Well, it was a bit tedious, but it was worth the effort: You now have a cool Pac Man animation!

Add an eye to Pac Man

Even after the image actions are all defined, you can still modify the images that they use. For example, you could add an eye to the yellow Pac Man. Note that to change the images, you will be working in the upper Image section of the image dialog. Do not click on anything in the lower Image Action section.

- Select "01 Circle" in the Image list box.
- Use the right mouse button to erase some pixels on the yellow Pac Man to make an eye.
- Click on the Image "Modify" button in the upper Image section (not the lower Image Action "Modify" button).
- Repeat the same process for "02 Half open" from the Image list box.
- Repeat the same process for "03 Full open" from the Image list box.

Play it again, Sam

Play the animation again, and you will see the eye in the entire animation.

5.4.4.6 Creating Text

In the [Light-O-Rama SuperStar Sequencer](#), text can be stationary or can move in any direction. At the end of the movement, the text can be stopped and displayed stationary for a specified period of time. Different size fonts can be used, and you can choose the text color or let the text be rainbow colored.

Text can be treated as a positive mask or a negative mask. Let's get started!

- [Select Wide Grid or Thin Grid](#)
- [Set Layout to 24 ribbons](#)
- [Get a new screen](#)
- [Launch the Text dialog box](#)
- [Observe the default settings](#)
- [Add a text action](#)
- [Play the text action](#)
- [Change the color of the text](#)
- [Modify and play the text action](#)
- [Change Rotation to 0 degrees and set Direction of Motion to left](#)
- [Try different rotations and directions of motion](#)
- [Rainbow](#)
- [Rainbow start color](#)
- [Change the start color](#)
- [Try a different font and change the text](#)
- [Discussion on fonts](#)
- [Custom fonts](#)
- [Discussion](#)
- [What is a text mask?](#)
- [Try some positive mask text](#)
- [Apply a background effect](#)
- [Understanding a positive text mask](#)
- [It works with morphs too!](#)
- [Move the morph to the foreground](#)
- [Negative text masks](#)
- [Discussion](#)
- [Applying normal text to the background of a text mask](#)
- [Summary](#)

Select Wide Grid or Thin Grid

At the right end of the toolbar are three buttons that control how the ribbons are laid out. The text will be harder to read if you have "Star Rays" selected. Select "Wide Grid" or "Thin Grid" and the text will be easier to read.

Set Layout to 24 ribbons

Click on the Tools menu and select Layout. In the layout dialog box, set the Number of Ribbons to 24. We may not actually have 24 ribbons, but for the sake of this exercise, let's pretend we do!

Get a new screen

Click on the toolbar button that has a piece of a paper on it.

Launch the Text dialog box

Click on the Tools menu and select "Text". The Text Setup dialog box will launch. Whenever the Text Setup dialog box is launched, "Text" mode is automatically selected and the toolbar button with "ABC" on it will be depressed.

Observe the default settings

By default, the color is white, font is "8-8x8 Thin - System", time duration is 1.00 - 5.00 seconds, text is "ABCDEF", text mode is Normal, rotation is 90 degrees, direction of motion is Up, and Stop at Edge is unselected.

Add a text action

In the Text Action group, click on the "Add" button.

Play the text action

Click on the Play button. You should see "ABCDEF" scroll like a marquee from the bottom to the top of the ribbons.

Change the color of the text

Currently, the text is white. Leave the red color control at 100, but change the green and blue color controls both to 0. The text preview will now be red.

Modify and play the text action

In the Text Action group, click on Modify, then play the text action again. Red text will scroll from the bottom to the top.

Change Rotation to 0 degrees and set Direction of Motion to left

Set Rotation to 0 degrees and set Direction of Motion to Left. Click on Modify, and play the text action. Red text will scroll from right to left across the ribbons.

Try different rotations and directions of motion

You can mix and match the rotation and direction of motion. Try some different combinations. Remember to always click on Modify and then to click on Play to see the results of your new settings. Also, try "Stop at Edge" to see what it does.

Rainbow

In the Color/Mask group, select Rainbow. Each character of the text now becomes a different color. Click on Modify, and play the text action with rainbow colors.

Rainbow start color

You can set the start color of the rainbow. For this exercise, use the following settings:

- Set Color to Rainbow
- Leave Mask at Normal
- Set Rotation to 90 Degrees
- Set Direction of Motion to Center

- Unselect Stop at Edge
- Set Start time to 1.00 seconds and End time to 2.00 seconds

Click on Modify and play the text. The rainbow text will be centered on the ribbons and will not move.

Change the start color

- Set Start time to 2.00 seconds and End time to 3.00 seconds.
- Set the start color to orange.
- Click on Add. You will now have two text actions.
- Click on Play.

The rainbow colors will display with red as the start color from 1.00 to 2.00 seconds, and then the text will display with orange as the start color from 2.00 to 3.00 seconds.

By continuing to add text actions one after another with different start colors, you can make the colors move across the characters!

Try a different font and change the text

- Delete any text actions that you currently have. You can do this by clicking on Delete until all text actions in the Text Action list box are gone.
- In the Font list box, select "10-12x12 Bold - System". The text will become larger.
- In the Text field in the middle of the dialog box, change "ABCDEF" to "Merry Christmas!"
- Set the start time to 1.00 seconds and the end time to 5.00 seconds.
- Set Color to Rainbow.
- Set Start Color to whatever color you want.
- Set Rotation to 270 Degrees.
- Set Direction of Motion to Down.
- Unselect Stop at Edge.

Click on Add and play the text action. "Merry Christmas!" will scroll from top to bottom in rainbow characters.

Discussion on fonts

We just used the font "10-12x12 Bold - System". The first number in the name is the pixel height of a capital letter. The second and third numbers are the character cell width and height. In this font there are two pixels reserved for the lower case descenders (for example, the bottom tail of a "y"). This is why the height of the character cell, 12, is greater than the height of a capital letter, 10.

Note that in the smaller fonts, the cell height is the same as the capital letter height. This is because there are not enough pixels to reserve room for lower case descenders. In those fonts, the tail of a "y" does not go below the bas line.

As mentioned, the second number is the font character cell width, but realize that this is an average width. The width of any individual character may be different.

Custom fonts

In the font list, there are five system fonts and five custom fonts. The custom fonts are shipped identical to the system fonts. The only difference is that system fonts are not allowed to be modified, while the custom fonts are. If you wish to tweak some of the characters in a font, you can do so in any of the custom fonts. For example, let's say we want to make the exclamation point bigger in the "10-12x12 Bold - Custom" font. To do this, do the following:

- In the central area of the dialog box, select the radio button labeled "Font Character Entry".
- In the font list, select "10-12x12 Bold - Custom". It should be the second to last font in the list. The Modify button in the Chars group will become enabled.
- In the Char list, select the "!" character (the second character in the list).
- The char cell width is 4; change this to 6 and click on the Modify button immediately below the Char list. Note that the yellow line indicating the char cell width changed from 4 to 6.
- The current "!" character is two pixels wide. Redraw the pixels to make a fatter 4 pixel wide "!" character.
- Click on the Char List Modify button again.
- Now click on the Save button immediately below the Font list. This saves your change to a file.
- Click on the Text Action Entry radio button.
- Type the word "Merry!" as the text.
- In the font list, select "10-12x12 Bold - Custom". You should see the new exclamation point that you customized.

Discussion

You now know how to control many features of a text action. You can move the text, have it stand still, rotate the text, change its color, change the font, and even customize the characters within a font. But there is more.

What is a text mask?

In the Color/Mask group, there are three radio buttons, labeled "Normal", "Pos Mask", and "Neg Mask". So far we have done everything with the "Normal" setting. Normal means that there is no mask applied, and the text will behave normally. "Pos Mask" and "Neg Mask" are advanced features that allow you to apply any effect to the background and/or foreground of text.

Try some positive mask text

- Delete any text actions that you have by clicking on the Delete button until all text actions are gone from the list.
- Set the start time to 1.00 seconds and the end time to 5.00 seconds.
- Type the word "Merry" as the text.
- Select font "10-12x12 Bold - System".
- Set Color/Mask to Choose Color.
- Set Color to red by setting red to 100, green to 0, and blue to 0.
- Set Pos Mask.
- Set Rotation to 270 Degrees.
- Click on Add.
- Play the text action.

The word "Merry" appears in red in the center of the ribbons. Nothing special yet...

Apply a background effect

- Click on Tools and select Scenes.
- Set the start time to 2.00 seconds and the end time to 4.00 seconds.
- Set the start and end colors to blue.
- Set all the pixels in the pixel grid by pressing the Ctrl key and then clicking with the left mouse button on the pixel grid. All the pixels in the pixel grid should be blue.
- Click on Add.
- Play the text action.

You should first see the red "Merry", and then at 2.00 seconds the background should become blue.

Understanding a positive text mask

In the time layer area, there should be a red bar going from 1.00 seconds to 5.00 seconds. This bar is the Text mask. Click on this bar and the Text dialog should launch.

There is a box in the lower right area of the dialog box labeled "Mask Diagram". As the diagram shows, the effects above a text mask appear in the background, and the effects below a text mask appear in the foreground. So, let's try moving the scene from the background to the foreground.

- Select the blue bar in the time layers.
- Locate the "Move Effects Down" button in the toolbar. It is the fourth button from the right.
- The "Move Effects Down" button changes the layer of the effect. Click on it until the scene effect is below the mask.
- Click on Play.

This time the scene gets applied to the foreground and the text becomes purple from 2.00 to 4.00 seconds. Note: If the scene fails to get applied to the foreground, make sure the Positive Text Mask color is set to pure red - i.e. set red to 100, green to 0, and blue to 0.

It works with morphs too!

- Click on the scene and delete it.
- Click on the Tools menu and select Morphs. The Morph dialog box will launch.
- Set the start time to 2.00 seconds and the end time to 3.00 seconds.
- Set the start and end colors to green.
- Set the ramp time length to 0.50 seconds.
- Set the ramp start color to green and leave the ramp end color as black.
- Click on Add and then Play.

The text should appear and then the morph will be applied to the background. Text masks are cool!

Move the morph to the foreground

Click on the green bar in the time layers and move it to the other side of the mask. Click on Play.

This time the morph gets applied to the foreground of the text. Note: If the morph fails to get applied to the foreground, make sure the Positive Text Mask color is set to pure red - i.e. set red to 100, green to 0, and blue to 0.

Negative text masks

We started out using a positive text mask. Let's try a negative text mask.

- Leave the morph on the foreground side of the text mask.
- Click on the red bar in the time layers; the Text dialog box appears.
- Select "Neg Mask". A message box appears recommending that you set the text color to white when using negative masks. Answer "Yes" to the message box"; the text color will then be automatically set to white.
- Click on the Modify button and then Play. This time, you will see nothing until the morph gets applied to the text foreground.
- Move the morph to the background side of the text mask, and play. This time, you will see nothing until the morph is applied to the background.

Discussion

The weird thing about negative masks is that they are invisible until other effects are applied to their foreground and/or background. This seems weird at first, but it is the key to their power. You can apply multiple effects on either side of the mask. You can even apply image actions and normal text to the background or foreground. But you cannot apply a mask to a mask.

Applying normal text to the background of a text mask

- Move the morph to the foreground side of the mask.
- Set the morph start time to 1.00 and the end time to 2.00.
- Increase the ramp time to 3.00.
- Click on Play. You should see the morph applied to the foreground of the text mask.
- Click on the white bar in the time layer area; the Text dialog box is launched.
- Type "Christmas" for the text.
- Leave Rotation at 270 degrees.
- Click on Normal.
- Set Direction of Motion to DownRt.
- Set the color of the text to red.
- Set the start time to 2.00 seconds and the end time to 5.00 seconds.
- Click on Add.
- The red bar in the time layers represents the normal text you just added. Move it to the background side of the text mask.
- Click on Play.

The morph should play across the word "Merry", and "Christmas" should move across the background.

This same sequence is stored as a sample file named "TextMaskMerryChristmas.sup".

Summary

Text masks take some time to learn, but are well worth the effort. With all the other effects, the time layers were just a way to view the effects. With text masks, the layers have a new meaning. This tutorial explored only a few of the variety of text effects that are now possible. Cosmic Color Ribbons have been taken to a whole new level!

5.4.4.7 Transfer Effects from One Sequence to Another

In the [Light-O-Rama SuperStar Sequencer](#), using the clipboard, you can transfer effects from one sequence to another, as in this example:

- Open the file "JingleBellRock_24sec.sup", located in the Samples directory of the SuperStar Sequences directory.
- Scroll to the 16.00 second mark and you will see a stack of six white boxes in the time layers.
- Select the stack of boxes.
- Click on the Copy button.
- Click on the toolbar button with a piece of paper on it. This will do three things: It will clear the pixel grid, set the start color as red, and set the time duration to 1.00-2.00 seconds.
- Click on the Paste button, and the stack of boxes gets pasted to the new file.

5.4.4.8 Load/Save Clipboard

In the [Light-O-Rama SuperStar Sequencer](#), there are 20 sample effects that can be loaded into the clipboard. Once the effects are loaded into the clipboard, you can paste them into your sequence. Anything that you copy to the clipboard can also be saved to a file.

- [Start with a new sequence](#)
- [Launch the Load/Clip dialog box](#)
- [Load a sample file into the clipboard](#)
- [Paste the clipboard into your sequence](#)
- [Play the pasted effects](#)
- [Save your own clipboard effects](#)
- [Discussion](#)

Start with a new sequence

Click on the "New" button on the toolbar, which looks like a piece of paper.

Launch the Load/Clip dialog box

Click on the Edit menu, then select Load/Save Clipboard. You can also launch the dialog using Ctrl+A.

Load a sample file into the clipboard

At the top of the dialog box is a list of the saved clip files ("clip" is short for "clipboard"). All of the sample files start with "Sys -", meaning they are a system file that can be loaded but not saved to. Select the "SharkFinForHorizontalRibbons.scb" file, then click on "Load Clipboard from File".

Note that the lower half of the dialog box is now populated. In the description area are the description and instructions on how to modify the effects.

Paste the clipboard into your sequence

Once the clipboard is loaded, you can paste the effects into your sequence. There are four ways to do this:

1. Use the Paste button in the dialog box.

2. Use the Paste button on the toolbar.
3. Put the focus on the work area by clicking on the time layers area, and then press Ctrl-V.
4. Click on the Edit menu and select Paste.

Play the pasted effects

A shark fin will travel lengthwise across the ribbons, first one direction and then the other. The water underneath the shark fin will shimmer.

For demonstration purposes, the shimmering water is done in two different ways: The first time, it is done with scenes that fade between two intensities. The second time, it is an animation done with images. The description of this effect in the Load/Save dialog box describes how to modify the shark fin and the water.

Save your own clipboard effects

Any effects you have modified or created can be saved to file by doing the following:

- Select what you want to save.
- Click on the "Copy Effects" button on the toolbar.
- Press Ctrl-A to launch the Load/Save Clipboard dialog.
- In the Clipboard Name field, type your filename (such as "MyAwesomeEffects").
- Click on the "Save Clipboard to File" button.

Note that your file is now in the list of saved clip files.

Discussion

The load/save of the clipboard is a powerful feature! You can now store and easily transfer effects from one file to another. The shark fin effect shows how a shaded object can be drawn as an image action. Artists will have fun with this, and non-artists will be grateful they can copy and paste these images!

Currently the SuperStar Sequencer does not support importing .gif or .jpg images. However, realize that even if you have twelve CCRs, you only have 12x50 pixels to work with. This is very low resolution by computer standards. Import of images would typically not look good at such low resolution. The best images will always be those that are carefully tailored to the low resolution that we must work with.

5.4.4.9 Change to 10 Pixels per Ribbon

Cosmic Color Ribbons default to having 50 pixels per ribbon. Each pixel is actually a group of three LEDs with red, green, and blue elements. You will normally want to keep the ribbons in 50 pixel mode.

You can, however, change the number of pixels per ribbon to 25, 10, 5, or 1, using one of the macro commands built into the ribbons. The reason you may want to do this is to reduce the number of channel commands, making the effect more instantaneous. For example, a white morph that goes the full length of 12 ribbons will generate $12 \times 50 \times 3 = 1800$ commands. If the morph is fast, and tries to do this in a short period of time, like 0.4 seconds or less, you may perceive some lag in the ribbons. In a fast effect, you will get better results by using 10 pixels per ribbon, because it will use 1/5 the number of channel commands and so will eliminate the lag, and since it travels fast, it will still look good in 10 pixel resolution.

Here is an example of how to use both 10 pixel and 50 pixel resolution in the [Light-O-Rama SuperStar Sequencer](#):

- [Initialize the screen](#)
- [Launch the Macro dialog box](#)
- [Add a "10 pixel per ribbon" macro](#)
- [Add a scene inside the macro region](#)
- [Add a morph inside the macro region](#)
- [Add a morph outside the macro region](#)
- [Try to add a morph that straddles the macro](#)
- [Discussion](#)

Initialize the screen

Click on the toolbar button with a piece of paper on it. This will do three things: It will clear the pixel grid, set the start color to red, and set the time duration to 1.00 to 2.00 seconds.

Launch the Macro dialog box

Click on the Tools menu and select Macro.

Add a "10 pixel per ribbon" macro

- Set "Pixels Per Ribbon" to 10.
- Set the time duration to 1.00 to 3.00 seconds.
- Click on the Add button.

A bracket should appear in time layer 6.

Add a scene inside the macro region

- Click on the Tools menu and select Scene.
- Set the time duration to 1.00 to 2.00 seconds.
- Set some pixels at the top of the pixel grid.
- Click the Add button.

A scene should appear in time layer 1. Note that the scene only has ten pixels per ribbon in the pixel grid. Also note that the ribbons still display as if they were in 50 pixel mode, but when playing the sequene to the real Cosmic Color Ribbons, they will be in 10 pixel mode.

Add a morph inside the macro region

- Click on the Tools menu and select Morph.
- Set the time duration to 2.00 to 3.00 seconds.
- Click on the Add button.

A morph should appear in time layer 2. Note that the morph has ten pixels per ribbon in the pixel grid.

Add a morph outside the macro region

- Set the time duration to 5.00 to 6.00 seconds.
- Click on the "Add" button.

Note that the morph has 50 pixels per ribbon in the pixel grid.

Try to add a morph that straddles the macro

- Set the time duration to 2.00 to 4.00 seconds.
- Click on the Add button.

An error message will appear.

Discussion

When playing the sequence to the Cosmic Color Ribbons, the ten pixel macro will send a command 1/100th of a second before the macro time duration to set each ribbon in 10 pixel mode. It will send a command 1/100th of a second after the macro time duration to set each ribbon back to 50 pixel mode. No effects should be active when these commands are sent.

Note that at 32.45 in the sample file CarolOfTheBells.sup, there is a morph that uses 10 pixel mode. In this morph, all the ribbons burst downward into a flash of white. In normal 50 pixel per ribbon mode, this would require 1800 channels to be turned on in a very short period of time. Using 10 pixel per ribbon mode requires only 360 channel commands, and can make the effect more instantaneous.

5.4.4.10 "Star Rays", "Wide Grid", and "Thin Grid"

In the [Light-O-Rama SuperStar Sequencer](#), there are three buttons at the right end of the toolbar that will set the ribbons into "[Star Rays](#)", "[Wide Grid](#)", or "[Thin Grid](#)":

Star Rays

In this layout, morphs that come from the top to the bottom should accelerate, and the trail should get longer. Typical settings might be a start trail of 2 and an end trail of 12.

Scenes that come from the top to the bottom should get larger. The yellow perspective marks on the right side of the pixel grid are designed to help you do this.

Wide Grid

This view spaces the ribbons to give square pixels. That is, the space between the ribbons is equal to the height of each pixel. If you are using the ribbons primarily for animations and text, you will probably use a layout like this.

Thin Grid

This view spaces the ribbons closer together. The quality of the animations will improve, but it will take more ribbons to cover the same amount of area.

5.4.4.11 The Layout Dialog Box

In the [Light-O-Rama SuperStar Sequencer](#), the layout settings get saved into each .sup file. The layout you set also gets saved as a default layout. This default layout will be used for new sequences that you create.

- [Number of Ribbons \(1-24\)](#)
- [Ribbon Orientation](#)
- [Ribbon Shape](#)
- [Ribbon Length](#)
- [Location of Ribbon Controllers](#)

Number of Ribbons (1-24)

This will set the number of rows of ribbons if in horizontal view, or the number of columns of ribbons if in vertical view. Note that if you are using half ribbons, this setting is the number of rows, not the number of ribbons.

Ribbon Orientation

Setting "Vertical" will display the ribbons vertically in columns.

Setting "Horizontal" will display the ribbons horizontally in rows. Note that the star is not supported in the horizontal view.

Ribbon Shape

Setting "Straight" will display the ribbons in straight lines. This is the common way to display the ribbons.

Setting "Circle" will display the ribbons in circles. The start of the ribbon will be at the left center of each circle. This allows for a variety of circular patterns. Sequencing circles can be a challenge, but the results can be amazing. An example can be seen on the Light-O-Rama website with Deck the Halls for 2 CCRs and for 4 CCRs.

Ribbon Length

Setting "Full" will display the ribbons as a full length 50 pixel ribbon. This is the normal setting.

Setting "Half" will display the ribbons as a half length 25 pixel ribbon. The common use of this setting is to allow a matrix with fewer ribbons. For example, using 4 CCRs you can create a matrix of 8 rows with 25 pixels in each row. You can cut the ribbons per the instructions that come with the CCRs, but if you do this, you void the warranty. Another option is to loop the ribbons back without cutting them. You will lose some pixels in the loop, but you will not void the warranty.

When using half ribbons with the controller location set to "top/left", you are expected to lay them out as diagrammed below:

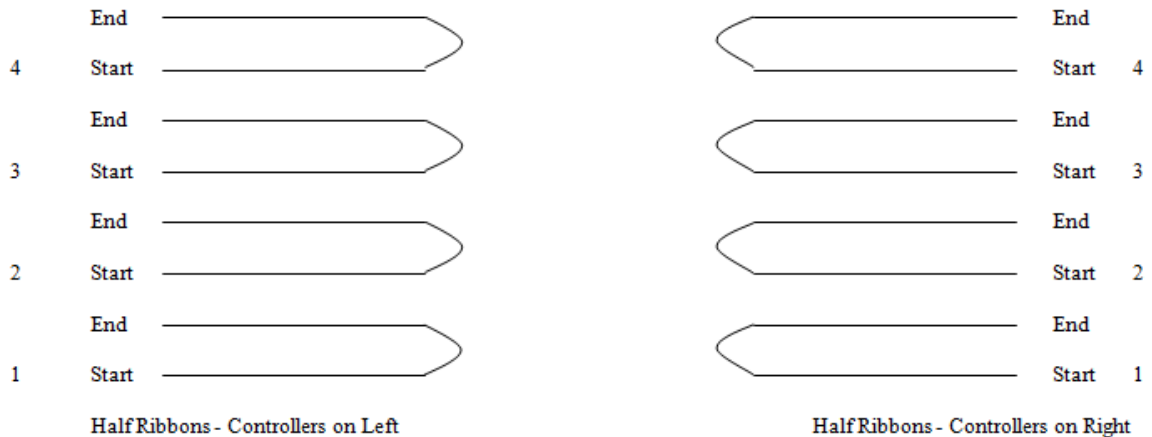

Location of Ribbon Controllers

Set "Top/Left" if your CCR controllers are on the top or left of your ribbons.

Set "Bottom/Right" if your CCR controllers are on the bottom or right of your ribbons.

Note that for a horizontal layout, the first controller should be at the bottom, and the last controller at the top. For a vertical layout, the first controller should be at the left, and the last controller at the right.

5.4.4.12 Balanced Color Mode / Full Color Mode

If you use the [Light-O-Rama Hardware Utility](#) to try various settings for the RGB values of CCR pixels, you will find three important characteristics:

First, the brightness is not linear. For example, a setting of 100 is only a little brighter than a setting of 50, but 50 is significantly brighter than 25.

Second, the red, green, and blue elements are not balanced. For example, on a computer screen, setting red to 100 and green to 100 will result in yellow, but on a CCR pixel, it will be more of a greenish yellow. This is because the CCR's green element is stronger than the red element. Setting red and blue to 100 will result in a bluish purple, because the blue element is stronger than the red element.

Third, the LEDs are so bright that the perceived colors will not be as deep as what you see on the computer screen. This must be taken into account when comparing the colors on the computer screen with what you will get on the ribbons. For example, red 100 and green 50 will give a bright orange; red 60 and green 30 will give a dim orange that will show as a muddy orange on the computer screen, but on the Cosmic Color Ribbons it will still be a fairly bright orange.

- [Making the brightness linear](#)
- [Balanced Color Mode](#)
- [Full Range Color Mode](#)
- [Go Back to Balanced Color Mode](#)

Making the brightness linear

The [Light-O-Rama SuperStar Sequencer](#) automatically adjusts the start and end settings to make them linear. For example, a start setting of 50 in the SuperStar Sequencer will export to a setting of 25 in the [Sequence Editor](#). This gives the proper intensity for the start and end color of an effect. But realize that a ramp that goes from 100 to 0 will not go from 100 to 0 smoothly: The hardware will bring the voltage down from 100% to 0% smoothly, but the brightness will go down slowly at first, then quickly at the end. The SuperStar Sequencer simulates this fast drop off when it plays the sequence onto the ribbons. Note that this fast drop off can be solved using the "[Smooth Ramps](#)" setting.

Balanced Color Mode

The SuperStar Sequencer defaults to "Balanced Color Mode". In this mode, the red element is used in its full range, but the green and blue elements are limited to less than full brightness. So, for example, if you set red to 100 and green to 100, you will get a true yellow on the ribbon.

Full Range Color Mode

To set this mode, go to the Tools menu and select Configuration. When in Full Range Color Mode, the color controls will have the following ranges:

- Red: 0-100
- Green: 0-120
- Blue: 0-130

In this mode, setting red, green, and blue all to 100 will give the same results as in Balanced Color Mode. Setting red to 100, green to 120, and blue to 130 will give a bluish white. The SuperStar Sequencer simulates this color shift, but to do so it must "dim down" the settings that are 100 and below in order to support simulation of the colors that are at 100 and above. Realize that even though the colors on the screen are dimmed down, the colors on the Cosmic Color Ribbon will not be.

Go Back to Balanced Color Mode

When going back to Balanced Color Mode, the SuperStar Sequencer advises that any settings greater than 100 will automatically be adjusted down to 100. Note that after going into Balanced Color Mode, the next time you click on a color control, a warning box may appear that says "Enter an Integer between 0 and 100." This is a bug which will be fixed in the future. Click "OK" on the warning box; if another warning immediately appears, click "OK" on that also. These warnings can be ignored.

5.4.4.13 Smooth Ramps

As discussed in the [Balanced Color Mode / Full Color Mode](#) section, the start and end setting of each color is adjusted by the [Light-O-Rama SuperStar Sequencer](#) so that the brightness is linear. However, on a single fade, the SuperStar Sequencer cannot control the rate at which the brightness changes in between the start and the end. To get around this, the SuperStar Sequencer can use "smooth ramps". In smooth ramps mode, ramps that are one second long or longer are actually treated as ten short ramps. In this way, the SuperStar Sequencer gains control of the rate of change of the ramp. The fast change of ramps is not easily perceived for short ramps, but with very long ramps you will notice it. To see the example, try the following:

- [Set Smooth Ramps mode](#)

- [Add a non-smooth ramp](#)
- [Add a smooth ramp](#)
- [What are we doing?](#)
- [Observe the difference](#)
- [Summary](#)

Set Smooth Ramps mode

- Click on the Tools menu and select Configuration.
- Select Smooth Ramps in the Configuration dialog box.

Add a non-smooth ramp

- Launch the Scene dialog box.
- Select pixels 0-10 on the pixel grid.
- Set the time duration to 1.00 to 1.95 seconds.
- Set the start color to red = 100.
- Set the end color to red = 0.
- Click on the Add button.

The scene will be added to layer 1.

Add a smooth ramp

- Select pixels 11-20 in the pixel grid.
- In the scene dialog box, set the time duration to 1.00 to 2.00 seconds.
- Leave the start color at red = 100.
- Leave the end color at red = 0.
- Click on the Add button.

The scene should be added to layer 2 so that they both are stacked on top of each other.

What are we doing?

Both of the scenes cover almost the same time range. The two scenes should be stacked on top of each other. The pixels you selected should not collide (that is, each scene should turn on a different set of pixels).

Observe the difference

Click on the Play button. The first scene added is of a duration less than one second, so the ramp will not be smoothed. The second scene is a second long, and so the ramp will be smoothed.

Note that the top pixels (belonging to the first scene) will not drop in brightness as fast as the bottom pixels (belonging to the second scene).

Summary

When in Smooth Ramps mode, only ramps 1.00 second long and longer are smoothed. Even if you are in Smooth Ramps mode, smoothing is not done for ramps less than 1.00 second. This is because the smoothing of short ramps is not easily perceptible to the eye. Realize that any ramp

that is smoothed gets chopped up into ten ramps, and thus the number of commands is ten times greater, and the length of the exported sequence file is ten times greater for that effect. This is why smoothing of short ramps is not done.

Smooth Ramps mode defaults to off, but you can turn it on, and then the setting gets stored in both your launch configuration file and in the .sup file. It affects the export of a Light-O-Rama .lms or .las file, and as mentioned, exported files using smoothed ramps will be larger.

5.4.4.14 Configure Controller Unit IDs Using the Light-O-Rama Hardware Utility

After purchasing Cosmic Color Ribbons, you must configure them using the [Light-O-Rama Hardware Utility](#). There are instructions on how to do this in the manual that comes with the ribbons. You will assign a [unit ID](#) to each controller, the same as you would with any other [controller](#).

In addition, the Hardware Utility has a [Cosmic Color Ribbon Configuration screen](#). Be sure to use the following settings on it:

- Unit ID Mode: Normal (single ID).
- Channel Mode: Triples (RGB, RGB, ...)
- Resolution: 50 pixels
- Strips: 1
- DMX Mode: Both macro and RGB channels

The "Standalone Speed" setting does not matter with respect to the [Light-O-Rama SuperStar Sequencer](#).

5.4.4.15 Configure Controller Unit IDs in the SuperStar Sequencer

After [setting the unit ID for each of your Cosmic Color Ribbons with the Light-O-Rama Hardware Utility](#), you then must let the [Light-O-Rama SuperStar Sequencer](#) know which [unit IDs](#) you assigned.

Note that a Light-O-Rama unit ID is a hexadecimal number from 01 to F0. If they were decimal numbers, the ID would be from 1 to 240, but since they are hexadecimal, the IDs are 01, 02, 03, 04, 05, 06, 07, 08, 09, 0A, 0B, 0C, 0D, 0E, 0F, 10, 11, 12, 13, 14, 15, 16, 17, 18, 19, 1A, 1B, 1C, 1D, 1E, 1F, 20, and so on.

- [Launch the Configuration dialog box](#)
- [Set the unit ID of the star controller](#)
- [Set the unit ID of the first ribbon controller](#)
- [Network settings](#)
- [Examples](#)
- [Do I need more hardware to use more than one network?](#)
- [Setting more than one network in the Light-O-Rama Sequence Editor](#)

Launch the Configuration dialog box

Launch the [SuperStar Sequencer](#), click on the Tools menu, and select Configuration.

Set the unit ID of the star controller

If you are not using a star, select "No" underneath "Star in Use". The Unit ID field will be dimmed, indicating that no [unit ID](#) for a star [controller](#) will be used.

If you are using a star, select "Yes" underneath "Star in Use". Set the unit ID of the Light-O-Rama controller for the star using the dropdown list.

The typical Light-O-Rama controller has 16 channels. Note that if you use the star, you must use the first 6 channels of the controller for it. The remaining 10 channels will not be used by the [SuperStar Sequencer](#), which means you can use them in your main [sequence](#) if you choose to do so.

Set the unit ID of the first ribbon controller

Set the [unit ID](#) of the first ribbon [controller](#) using the dropdown list. The remaining ribbon controllers must be assigned unit IDs that are in successive numeric order, keeping in mind that they are hexadecimal numbers. For example, if you have four ribbons, and the first ribbon has unit ID 18, then the next three ribbons must have unit IDs 19, 1A, and 1B.

Network settings

Generally speaking, Light-O-Rama supports up to 16 [Light-O-Rama networks](#), but the [SuperStar Sequencer](#) currently only supports up to four of them. The default setting for the SuperStar Sequencer is to use one network (the Standard network), with the other three networks (Auxiliary Networks A, B, and C) disabled. When using one network (the Standard network), you must set the first and last [unit IDs](#) that are controlled by the network.

If using more than one network, enable the auxiliary networks you are using and set the first and last unit IDs controlled by each auxiliary network.

Examples

- [Setting up one network for the star and 12 ribbons](#)
- [Setting up one network for the star, 8 ribbons, and other lights](#)
- [Setting up four networks with no star, 24 ribbons, and other lights](#)

Setting up one network for the star and 12 ribbons

Let's say we have a star, 12 ribbons, and no other lights. We are controlling the star with a standard 16 channel [Light-O-Rama controller](#) that has [unit ID](#) 01, and the twelve ribbons are controlled by their respective controllers with unit IDs 02 through 0D. Then we would use the following settings:

- Star in Use: Yes
- Unit ID of Star Controller: "01"
- Unit ID of First Ribbon Controller: "02"
- Standard Network: Enabled
- Standard Network, Unit ID of First and Last Controller: "01" "0D"
- Auxilliary Networks: Disabled

Setting up one network for the star, 8 ribbons, and other lights

Let's say we have a star and 8 ribbons, and will be running them alongside other lights. We are controlling the star with a standard 16 channel [Light-O-Rama controller](#) that has [unit ID](#) 01. We also have three other 16 channel Light-O-Rama controllers, with unit IDs 02, 03, and 04. The eight ribbons are controlled by their respective controllers with unit IDs 05 through 0C. Then we would use

the following settings:

- Star in Use: Yes
- Unit ID of Star Controller: "01"
- Unit ID of First Ribbon Controller: "05"
- Standard Network: Enabled
- Standard Network, Unit ID of First and Last Controller: "01" "0C"
- Auxiliary Networks: Disabled

Setting up four networks with no star, 24 ribbons, and other lights

Let's say we have no star, but 24 ribbons, and will be running them alongside other lights. We have 256 channels for other lights, which are controlled by 16 standard 16 channel [Light-O-Rama controllers](#) with [unit IDs](#) 01 through 10. We have 24 ribbons controlled by their respective controllers, with unit IDs 11 through 28. We want to run the various ribbons on four different [networks](#). Then we could use the following settings:

- Star in Use: No
- Unit ID of Star Controller: Disabled
- Unit ID of First Ribbon Controller: "11"
- Standard Network: Enabled
- Standard Network, Unit ID of First and Last Controller: "01" "10"
- Auxiliary Network A: Enabled
- Auxiliary Network A, Unit ID of First and Last Controller: "11" "18"
- Auxiliary Network B: Enabled
- Auxiliary Network B, Unit ID of First and Last Controller: "19" "20"
- Auxiliary Network C: Enabled
- Auxiliary Network C, Unit ID of First and Last Controller: "21" "28"

Do I need more hardware to use more than one network?

If you have one USB485 connector plugged into one USB port of your computer, then you are using one [network](#). To use more than one network, you must first purchase other USB485 connectors (one for each additional network). Plug in each USB485 connector to a different USB port on your computer. Then plug in the Cat 5 cable coming from each USB485 connector into the first controller of the network group you are going to control with that network.

Setting more than one network in the Light-O-Rama Sequence Editor

- Launch the [Light-O-Rama Sequence Editor](#).
- Click on the [Edit menu](#).
- Move the mouse down to [Preferences](#) at the bottom of the Edit menu; a flyout menu appears.
- Select Network Preferences from the flyout menu; the [Network Preferences dialog](#) appears.
- Select a comm port for each [network](#) that you plan to use.
- **Important:** For all networks you are using, select "[Short Range \(Faster\)](#)"

5.4.4.16 Channelizer

A source file for the [Light-O-Rama SuperStar Sequencer](#) ends with an ".sup" file extension. These files contain all the effects for the SuperStar sequence, but do not contain any information about what [unit IDs](#) your [controllers](#) have been configured to use. Each [channel](#) is assigned to its appropriate controller unit ID when you [export](#) the file to a ".sup.lms" [musical sequence](#) or a ".sup.las" [animation sequence](#) (which can only be done with a [paid version](#) of the SuperStar Sequencer, not with the demo version).

So, if you have a paid version of the SuperStar Sequencer, you can configure the unit IDs and then export the file, and your [sequences](#) will be configured for your particular unit IDs.

If you purchase a SuperStar sequence, it comes with the exported .sup.lms sequence files, so that even if you do not have a paid version of the Light-O-Rama SuperStar Sequencer, you can still play the sequences using the [Light-O-Rama Sequence Editor](#) or [Show Player](#). However (with the demo version of the SuperStar Sequencer) you have no way of changing the unit IDs that the channels are assigned to (from within the SuperStar Sequencer).

Therefore, the demo version of the SuperStar Sequencer has a "Channelizer". The Channelizer reads a .sup.lms file and creates a new .sup.lms file with the channels reconfigured to your unit IDs.

Before you use the Channelizer, you must first tell the software what unit ID you have assigned to your first CCR controller. To do this, click on the Tools menu, then click on Configuration. This will launch the Configuration dialog box. We will use an example where you have six standard 16 channel LOR controllers, which have been assigned unit IDs 01 through 06, and twelve CCR controllers with the next twelve unit IDs (which would be 07, 08, 09, 0A, 0B, 0C, 0D, 0E, 0F, 10, 11, and 12). The standard LOR controllers and the first six CCRs will be on the Standard network, and the remaining six CCRs will be on the Aux A network.

The SuperStar sequences assume that you have assigned your CCR controllers' unit IDs in order. If you have a vertical CCR matrix, then you should order your CCR unit IDs from left to right. If you have a horizontal CCR matrix, then you should order your CCR IDs from bottom to top.

Since your first CCR controller has been assigned unit ID 07, then in the SuperStar Configuration dialog box, select "07" for the "Unit ID of First Ribbon Controller".

In the network section, Standard Network should be selected, and the "Unit ID of First and Last Controller" for the Standard network should be "01" "0C".

Auxiliary Network A should also be selected, and its first and last controllers should be set to "0D" "12".

When you are done, the dialog box should look like this:

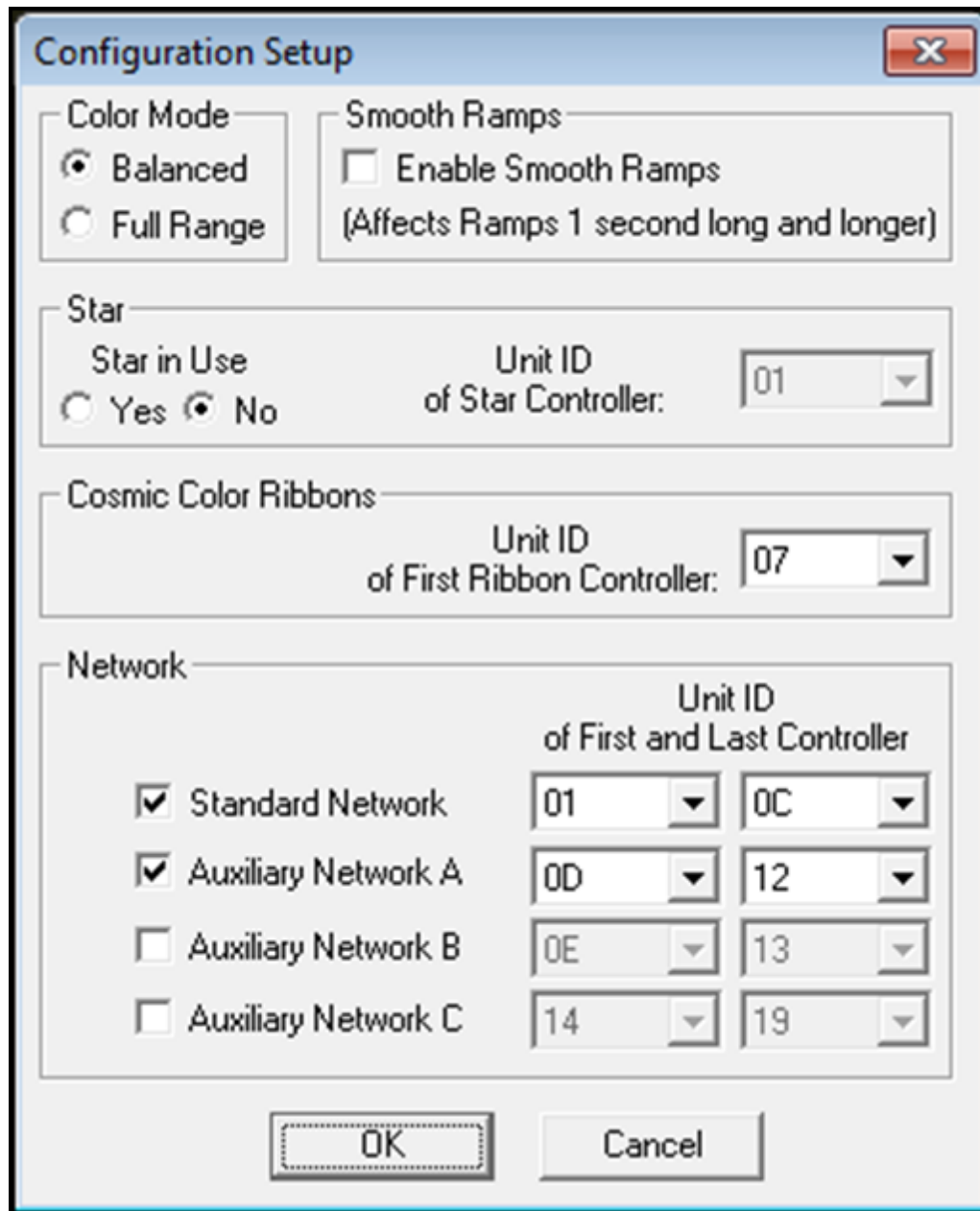

The Configuration dialog

Click on OK, and you have now told the SuperStar Sequencer what unit IDs should be used for your CCRs. You are now ready to "channelize" the sequence files:

In the SuperStar Sequencer, click on the File menu, and select "Channelize...". For example, if you have purchased the Carol of the Bells sequence, and your controllers are on the bottom of the CCR matrix, then you would open the file CarolOfTheBells_Bottom.sup.lms.

After opening the file, the SuperStar Sequencer will automatically create a new file with your configuration encoded in the filename. In this example, the channelized file it will create will be named "CarolOfTheBells_Bottom_r1u7_Ar7u13.sup.lms".

The "r1u7" in the filename means that ribbon 1 is assigned to unit number 7 (which has unit ID 07) in the

standard network. The "Ar7u13" means that ribbon 7 is assigned to unit number 13 (which has unit ID 0D) in the Aux A network.

Copy the channelized file to your Light-O-Rama Sequences directory, and you can now play the channelized sequence using the Light-O-Rama Sequence Editor.

5.4.4.17 Select All, Select All Left, and Select All Right

In the [Light-O-Rama SuperStar Sequencer](#), you will find these actions in the Edit menu. "Select All" will select all effects in the SuperStar sequence; "Select All Left" will select all that are left of the time selected in the time scale; "Select All Right" will select all to the right of the time selected in the time scale.

Select All is useful for adding some blank space to your SuperStar sequence: If you needed to create a small amount of blank space at the beginning of a sequence, you could Select All, then use the Nudge Right button. To create a large amount of space, you could Select All, press the Cut button, select a time on the time scale, and then press the Paste button.

Similarly, Select All Right is useful for creating some blank space in the middle of your SuperStar sequence: You could Select All Right, Cut, then Paste at the desired new location.

5.4.4.18 Importing a Timing Grid and up to 3 Timing Channels

In the [Light-O-Rama SuperStar Sequencer](#), you can create a timing grid and timing marks by clicking on the Tools menu and selecting "Create Timings". However, if you already have a [timing grid](#) and some timing [channels](#) that you have created in the [Light-O-Rama Sequence Editor](#), you can import one timing grid and up to three timing channels from a [sequence](#) file:

- Launch the SuperStar Sequencer.
- Click on the Tools menu, select Layout, and set the number of CCRs that you have.
- Click on the File menu, and select Import Timings.
- Uncheck "Import First Freeform Timing Grid".
- Type the name of the timing grid to import.
- Type the name of the first timing channel to import.
- Type the name of the second timing channel to import.
- Type the name of the third timing channel to import.
- Click on the "..." button and select the sequence file that you wish to import timings from.
- Click on OK.

The timing grid and timing marks will appear at the top of the time layers.

5.4.5 Visualization Sequences

The [Light-O-Rama SuperStar Sequencer](#) can import visualizations created using the [Light-O-Rama Visualizer](#).

- [Import Visualization](#)
- [Special notes on Import Visualization](#)
- [Instant Sequences using a visualization](#)
- [Is the SuperStar program now a Visualizer program?](#)
- [Selecting a light fixture](#)
- [Adding an effect](#)
- [Play the effect](#)
- [Add a morph](#)

- [Play it](#)
- [The concept](#)
- [Instant Sequence](#)
- [Future enhancements](#)

Import Visualization

To use this feature, click on the [SuperStar Sequencer's](#) File menu and select "Import Visualization...". The Import Visualization dialog box will appear:

- **Sorted by Rows:** This is the default. Your lights will be sorted by rows, and each light [fixture](#) will be represented by a box on the green sequencing rows. The program does its best to sort your lights along the rows that it sees. Many light displays have two or three rows of lights; for instance, there could be lights at the roof line, the window line, and the ground line. In that case, the program will create three rows of green sequencing squares above your visualization. The first row will contain the light fixtures that the program found at the roof line, the next row will contain the light fixtures that the program found at the window line, and the third row will contain the light fixtures the program found at the ground line. Note that this is just an example; the program may find a different number of rows in your visualization.

A sequencing row can only have 50 boxes, so if you have more than 50 light fixtures in a row on your visualization, then the light fixtures will be split into more than one sequencing row. Also, if you have a prop with many light fixtures in it, the program does its best to not split the prop between lines.

CCRs are always placed first. The sorting applies only to props and light fixtures.

In short, the program sorts things in a way that makes it easiest to sequence, and will produce the best instant sequences.

- **Sorted by CCDevice, Props, Fixtures:** Your lights will be sorted by CCDevice, [props](#), and then light fixtures. CCRs will be first, props will be next (sorted by row), and light fixtures will be last (sorted by row). This would be useful if you had two mega trees and wanted to do morphs across both mega trees.
- **Native (same order as created):** No sorting is done; the CCRs, props, and light fixtures are put in the same order that they were created in when you created the visualization. Depending on what order you created objects in the [Visualizer](#), you could end up with things being in a somewhat random order in the green sequencing grid.
- **Scrunch the Sequencing Grid:** As mentioned, sorting by rows gives the best instant sequences, but may create more rows than you have a [license](#) for. If you have purchased the 2_CCR license level, you can only export two sequencing rows. So, if "Sorted by Rows" put your lights into three or more rows, you will not be able to export all rows. In this case, you can use "Scrunch the Sequencing Grid", and it will scrunch everything into as few rows as possible. Using "Scrunch the Sequencing Grid" makes it so if you have 100 light fixtures or less, you will be able to fit all of them onto two sequencing rows and will be able to export your sequences with the 2_CCR license level.

Special notes on Import Visualization

When importing your visualization, you may get the warning: "The visualization file being loaded

contains fixtures that have no assigned channels or duplicate channels. These fixtures will be drawn in dark grey and cannot be selected."

If you have light fixtures in your visualization that have no channels assigned to them, they will be drawn in dark gray in the SuperStar screen and will be inactive (meaning they cannot be selected and will never light up).

Also, SuperStar likes to have each channel assigned to only one light fixture. However, it is common to have a channel assigned to more than one light fixture. To solve this, the additional fixtures that are assigned to the channel are drawn in dark gray and are inactive, meaning that they cannot be selected and will never light up within SuperStar. However, when you export the sequence and play it from the [Sequence Editor](#) to your lights, or to the [Visualizer](#), all of the light fixtures connected to that channel will light up.

Instant Sequences using a visualization

The Instant Sequence also feature works for visualizations, using the following steps:

- Click on the File menu and select "Import Visualization"
- Select a visualization file that you created using the [Light-O-Rama Visualizer](#)
- Press Ctrl+I to launch the Instant Sequence dialog box, and use the three buttons in the lower left of the dialog box
- Click on the "Open Audio File" button to open your audio file
- Click on the "Sequence All" button
- Click on the "Play/Stop All" button

Is the SuperStar program now a Visualizer program?

No. The [SuperStar Sequencer](#) imports the visualization file and displays it in the SuperStar work area. The SuperStar Sequencer can only display the visualization file; the [Light-O-Rama Visualizer](#) is used to create or modify visualizations.

Selecting a light fixture

After importing a visualization file, you can click on any of the light string [fixtures](#) to select them. A single click selects one item, while Ctrl+click can be used to select additional items. A click and drag will select any item within the drag rectangle. Each light string fixture is also mapped to a box in the green sequencing grid. When clicking on a light fixture, you will see it become selected, and will also see a green square get selected. You can also select fixtures by clicking on the green squares. Left click selects, and right click deselects.

Adding an effect

- Select one or more light [fixtures](#).
- Click on the Tools menu and select Scenes. The Scene dialog box will appear.
- Click on the Add button in the Scene dialog box. A white bar will appear in the time layer area. This bar represents the effect you just added.

Play the effect

In the toolbar is a group of buttons that look like the controls on a tape recorder. Press the Play

button (the button with a right-facing triangle); this will play eight seconds of the sequence. After pressing Play, you should see your selected light [fixtures](#) turn on when the play cursor runs across the white bar which represents the effect that you just added.

Add a morph

- Click on the Tools menu and select Morphs. The Morph dialog box appears, and the first and last boxes in the green sequencing grid should have "1" and "2" on them.
- In the yellow time scale, select from 3.00 seconds to 4.00 seconds.
- Click on the Add button in the Morph dialog box.

A white bar with a tail should appear in the time layer area.

Play it

Click on the Play button again. When the play cursor runs across the white bar with a tail, the morph will turn on every [fixture](#), one at a time. In other words, the effect starts at the "1" on the green sequencing grid, and travels to the "2" on the green sequencing grid. This ends up doing a sweep or a chase across all the fixtures.

The concept

Every light in your visualization has a location and a color. When selecting a [fixture](#), you have selected a location. You select the color by using the red, green, blue and white color controls on the left side of the [SuperStar Sequencer](#). The default is to have all four color controls "on". However, if you want to turn on all the red lights in your display, turn on only the red color controls and select all your fixtures. Add a scene, and you will see only the red lights in your display turn on when you hit the Play button.

Note: Click on the word "Main" above the color controls, and it will cycle through the basic rainbow colors.

Instant Sequence

You can use the [Instant Sequence](#) feature on your visualization:

- Click on the Tools menu and select "Instant Sequence".
- If you don't already have an audio file loaded, click on the "Open Audio File" button in the Instant Sequence dialog box.
- Click on the "Sequence All" button.
- After all the processing is done, click on the "Play/Stop All" button.

If you want to change the number of effects that are being created, click on the Timing Map button in the upper left of the Timing Map dialog box, and change the Sensitivity setting.

To create a different instant sequence, click on the "Roll Dice" button in the Instant Sequence dialog box. Then click on Sequence All, then Play/Stop All.

Future enhancements

While a wide range of visualizations have been tested with the [SuperStar Sequencer](#), there is an

even wider range of possible visualizations, and so it is difficult to test every scenario. So, as you work with your particular visualization, feedback is welcomed on ways that support can be improved for your particular needs. Please send such feedback to wishlist@lightorama.com.

5.4.6 Summary of Commands and Keyboard Accelerators

The following pages in this help file summarize various commands and keyboard accelerators in the [Light-O-Rama SuperStar Sequencer](#):

- [Toolbar Summary](#)
- [Toolbar Buttons that have Keyboard Modifiers](#)
- [Timeline and Effect Object Selection](#)
- [Top Part of Color Controls](#)
- [Color Picker Dialog Box](#)
- [Bottom Part of Color Controls](#)
- [Sequencing Grid Commands for Scenes](#)
- [Selection Grid Commands for Morphs](#)

5.4.6.1 Toolbar Summary

The following is a summary of the various buttons in the toolbar of the [Light-O-Rama SuperStar Sequencer](#):



New Sequence, Open Sequence, Save Sequence, Cut, Copy, Paste



Delete a selected group, Fast Rewind, Rewind, Pause or Freeze Frame, Stop, Play 8 seconds, Forward, Fast Forward, Play All



Set or add a scene, Scene Mode, Morph Mode, Image Mode, Text Mode

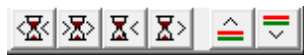

Nudge Left, Nudge Right, Nudge Length Left, Nudge Length Right, Move Effects up, Move Effects Down



Star Rays, Wide Grid, Narrow Grid





Select Props, Select Fixtures

See also [Toolbar Buttons that have Keyboard Modifiers](#).

5.4.6.2 Toolbar Buttons that have Keyboard Modifiers

The following is a summary of toolbar buttons that have keyboard modifiers in the [Light-O-Rama SuperStar Sequencer](#):

Shift +  = Paste and keep all effects in their original locations

Ctrl +  = Fast rewind to beginning

Ctrl +  = Fast forward to end

 = Freeze frame mode: Use the left and right arrow keys to step through the sequence.

Ctrl +  = Big nudge left

Ctrl +  = Big nudge right

Ctrl +  = Big nudge length left

Ctrl +  = Big nudge length right

See also [Toolbar Summary](#).

5.4.6.3 Timeline and Effect Object Selection

The timeline and selecting effect objects in the [Light-O-Rama SuperStar Sequencer](#):

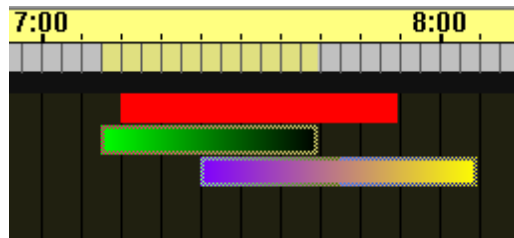

Timeline and Effect Object Selection

Dragging the mouse on the gray area of the timeline will select the time duration.

Selecting an object will also set the time duration in the timeline.

Ctrl+mouse click on an unselected object will add that object to the selection group.

Ctrl+mouse click on a selected object will remove that object from the selection group.

Ctrl+mouse drag on unselected objects will add those objects to the selection group.

Ctrl+mouse drag on selected objects will remove those objects from the selection group.

5.4.6.4 Top Part of Color Controls

The top part of color controls in the [Light-O-Rama SuperStar Sequencer](#):



Top part of color controls

Left click on a color box, or on "Main" or "Tail" = Step through the 8 basic color wheel colors.

Right click on a color box, or on "Main" or "Tail" = Launch the [Color Picker dialog box](#).

5.4.6.5 Color Picker Dialog Box

The Color Picker dialog box of the [Light-O-Rama SuperStar Sequencer](#):

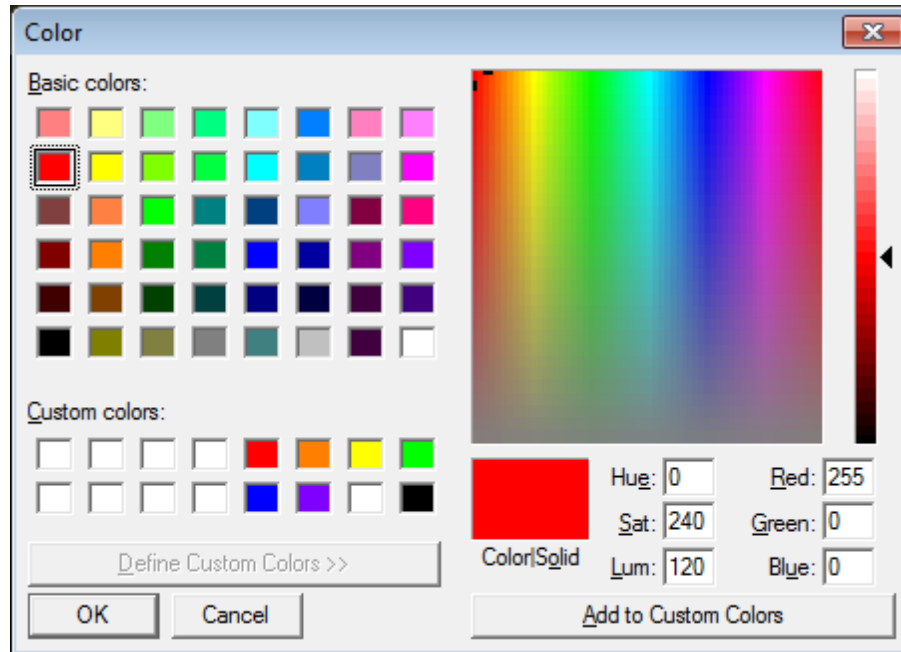

The Color Picker dialog box

Select a color and click OK to set the color.

Note that the eight basic colors of the color wheel are already among the custom colors.

5.4.6.6 Bottom Part of Color Controls

The bottom part of color controls in the [Light-O-Rama SuperStar Sequencer](#):

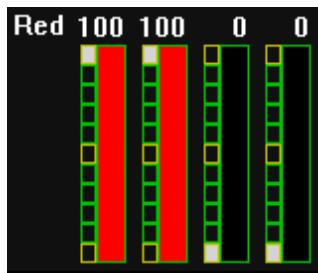

Bottom part of color controls

Mouse click on the control to set the intensity. Mouse drag will also set the intensity.

Double click on the first color to set the second and third colors also. For example:

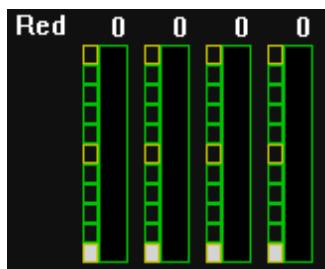

Before a double click on the first color

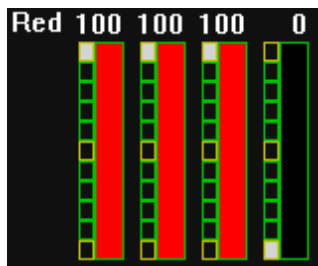

After a double click on the first color

5.4.6.7 Sequencing Grid Commands for Scenes

Sequencing grid commands for scenes in the [Light-O-Rama SuperStar Sequencer](#):

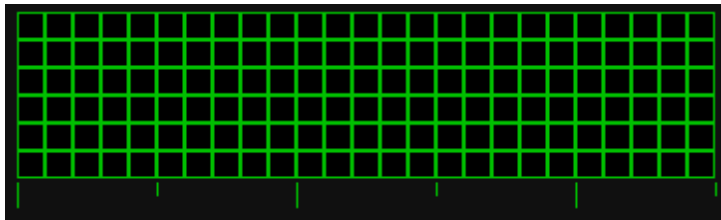

Sequencing grid for scenes

- Left mouse click = Set a pixel.
- Right mouse click = Clear a pixel.
- Left mouse drag = Set pixels.
- Right mouse drag = Clear pixels.
- Ctrl+left mouse click = Set all pixels.

- Ctrl+right mouse click = Clear all pixels.
- Shift+left mouse click = Toggle pixel.
- Shift+left mouse drag = Toggle pixels.

Example of a toggle:

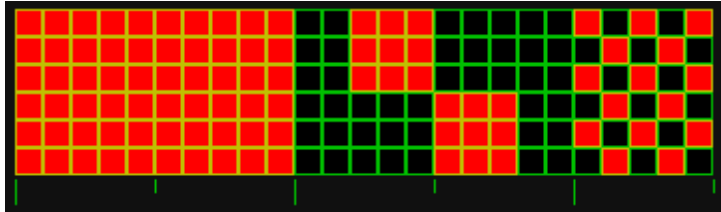

Before Shift+left mouse drag

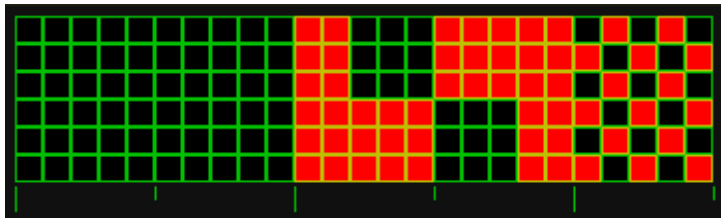

After Shift+left mouse drag

5.4.6.8 Selection Grid Commands for Morphs

Selection grid commands for morphs in the [Light-O-Rama SuperStar Sequencer](#):

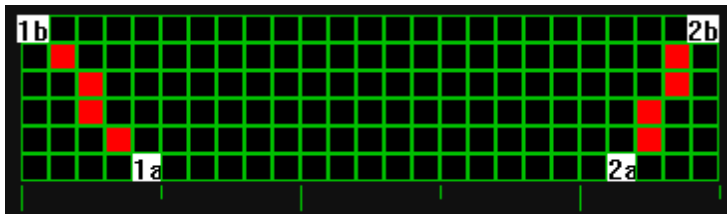

Selection grid for morphs

Left mouse drag to set the State 1 line: "1a" marks the beginning of the left mouse drag; "1b" marks the end.

Right mouse drag to set the State 2 line: "2a" marks the beginning of the right mouse drag; "2b" marks the end.

When the morph is performed, "1a" morphs to "2a", and "1b" morphs to "2b".

5.5 Show Editor

The Light-O-Rama Show Editor is used to create [shows](#). Shows are groups of [sequences](#) to be played as a group. They can be [scheduled](#) to play at certain times using the [Schedule Editor](#), and will then be played using the [Show Player](#).

To start the Show Editor, you can run it from your computer's Start Menu by selecting "All Programs" -> "Light-O-Rama" -> "Light-O-Rama Show Editor". Alternatively, if the [Light-O-Rama Control Panel](#) is already running, you can right-click its icon in your computer's system tray, and select "Show Editor" from the popup menu that will open.

Shows consist of several sections. Each section serves a different purpose - for example, the "[startup section](#)" is a list of sequences that will be played when the show begins, while the "[animation section](#)" is a list of animation sequences that will be played throughout most of the show's duration (after startup and before [shutdown](#)). All sections are optional.

For details on each of the sections, please refer to the following:

- [The Background Section](#)
- [The Startup Section](#)
- [The Animation Section](#)
- [The Musical Section](#)
- [The Interactive Section](#)
- [The Shutdown Section](#)

The Show Editor consists of six main tabs, and a toolbar at their top. Each of the tabs is associated with one of the six sections of the show (such as "background" and "animation"), while the toolbar has buttons to create, open, and save shows.

To add a sequence to a section, click on that section's tab, and then on the large "+" button. This will prompt you for the name of the sequence that you want to add. Similarly, to remove one, select the sequence from the section's list by clicking on its name, and then click the large "-" button.

A sequence can be moved up or down in a section's list by clicking on its name and then on the large up arrow or down arrow buttons. This generally affects the order that the sequences will be played in, but not always: For example, in the musical section, you can select that the sequences will be played in the order listed, or in a random shuffle; if you choose the latter, it doesn't matter what order they are listed in. Similarly, in the animation section, you can select that the sequences be played simultaneously (as opposed to sequentially); if you do, their listed order does not matter.

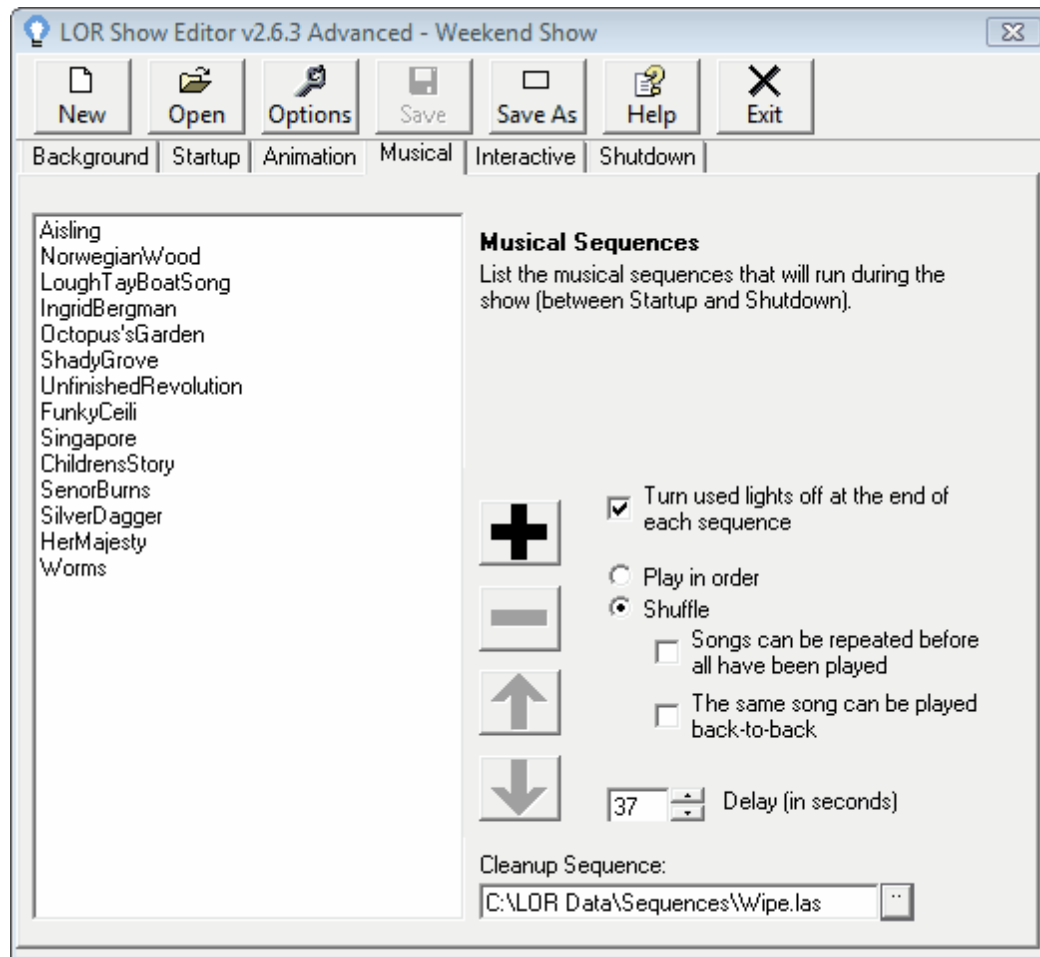

The Show Editor's tab for the musical section of a show

5.6 Schedule Editor

The Light-O-Rama Schedule Editor is used to [schedule shows](#) to be played at certain times. Shows are created using the [Light-O-Rama Show Editor](#), and consist of [sequences](#), which are created using the [Light-O-Rama Sequence Editor](#). Scheduled shows are then played by the [Light-O-Rama Show Player](#).

To start the Schedule Editor, you can run it from your computer's Start Menu by selecting "All Programs" -> "Light-O-Rama" -> "Light-O-Rama Schedule Editor". Alternatively, if the [Light-O-Rama Control Panel](#) is already running, you can right-click its icon in your computer's system tray, and select "Schedule Editor" from the popup menu that will open.

For an overview of schedules, please refer to:

- [Schedules](#)
 - [The Weekly Schedule](#)
 - [The Calendar Schedule](#)

For help on the Schedule Editor, please refer to:

- [Opening, Saving, and Reverting](#)
- [Switching between the Weekly and Calendar Schedules](#)

- [Adding a Show to the Weekly Schedule](#)
- [Adding a Show to the Calendar Schedule](#)
- [Editing a Scheduled Show](#)
- [Deleting a Scheduled Show](#)

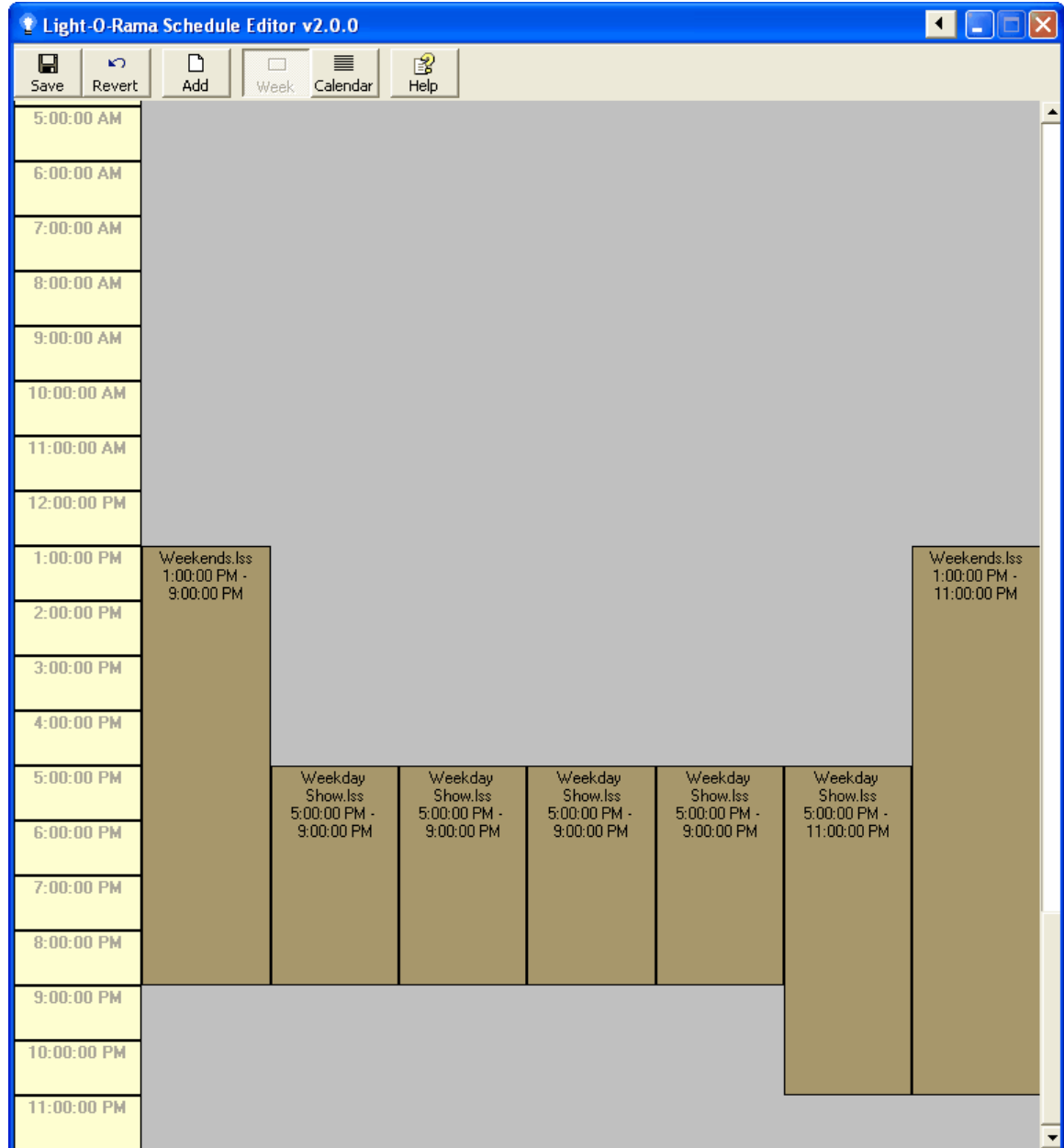

The Schedule Editor, showing the weekly schedule

Opening, Saving, and Reverting

Light-O-Rama maintains just a single [schedule](#) (with two parts - the [weekly schedule](#) and the [calendar schedule](#)), so when the [Schedule Editor](#) starts, it automatically opens and displays the current schedule. Once you start editing it, however, the displayed schedule may differ from the saved schedule. So, after you have edited the schedule and are satisfied with the changes you

made, click the toolbar's Save button to save your changes.

On the other hand, if you wish to discard your changes without saving them, click the toolbar's Revert button instead. Only the changes made since the last time that you saved will be discarded.

In order for the changes that you have made to the schedule to take effect, you must first save the schedule.

Switching between the Weekly and Calendar Schedules

The [schedule](#) consists of two parts - the [weekly schedule](#) and the [calendar schedule](#). The [Schedule Editor](#) only displays one of these two at a time, although both are always in effect.

When the Schedule Editor starts, it displays the weekly schedule. You can switch to the calendar schedule by pressing the toolbar's Calendar button, and you can switch back to the weekly schedule by pressing its Week button.

Adding a Show to the Weekly Schedule

With the [weekly schedule displayed](#), there are two ways to add a [show](#) to it:

- Click the toolbar's Add button.
- Click on an unscheduled area of the schedule and select "Add" from the popup menu.

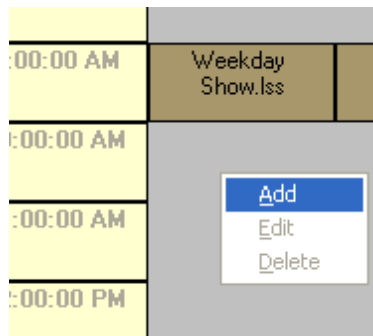

Adding a new show to the weekly schedule

In either case, the Add Show dialog will open:

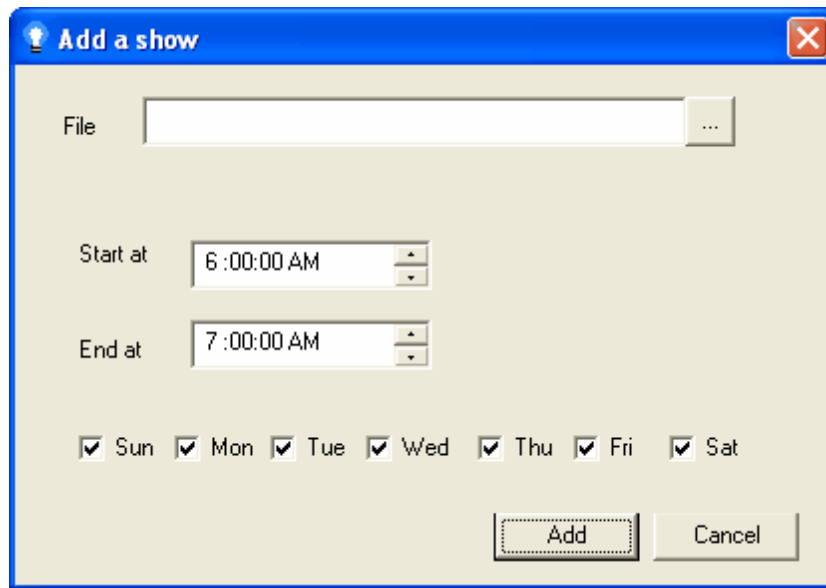

The Add Show dialog for the weekly schedule

Opening the Add Show dialog by clicking on an unscheduled area, rather than by using the Add button, has a couple advantages: First, it will automatically be populated with a start time and an end time based on where you had clicked. In the above example, the click was made at approximately 6:30 AM, and so the start and end times were automatically set to 6:00 AM and 7:00 AM.

Second, it automatically takes into account conflicts between the new show and any existing shows. For example, if there were already a show scheduled starting at 6:45, the end time of the new show would have automatically been set to 6:45 rather than 7:00. Similarly, if a show had already been scheduled at this time on Sunday, the "Sun" checkbox for the new show would have automatically been unchecked.

To add a new show using this dialog, first select the name of the show file; it is easiest to do this using the "..." button next to the File box, which will open up a dialog allowing you to choose among the existing show files.

Next, choose the start and end time for the show, and then select the day or days of the week that you wish this show to run.

Close the dialog by pressing "Add" (or "Cancel" if you no longer wish to add the new show), and [save your changes](#) by pressing the toolbar's "Save" button (or "Revert" if you wish to get rid of your changes).

Adding a Show to the Calendar Schedule

With the [calendar schedule displayed](#), there are two ways to add a new [show](#). In either case, first select the day that you want to schedule the show for (by clicking that day in the calendar), and then either:

- Click the toolbar's Add button, or
- Click on an unscheduled area of the schedule and select "Add" from the popup menu.

29 27 28 29 30 31

March 2008

Sat	Sun	Mon	Tue	Wed	Thu	Fri	Sat
2							1
9	2	3	4	5	6	7	8
16	9	10	11	12	13	14	15
23	16	17	18	19	20	21	22
	23	24	25	26	27	28	29
	30	31	1	2	3	4	5

4:00:00 AM
5:00:00 AM
6:00:00 AM
7:00:00 AM
8:00:00 AM
9:00:00 AM
10:00:00 AM
11:00:00 AM

Add
Edit
Delete

Adding a show to the calendar schedule for March 15, 2008

In either case, the Add Show dialog will open:

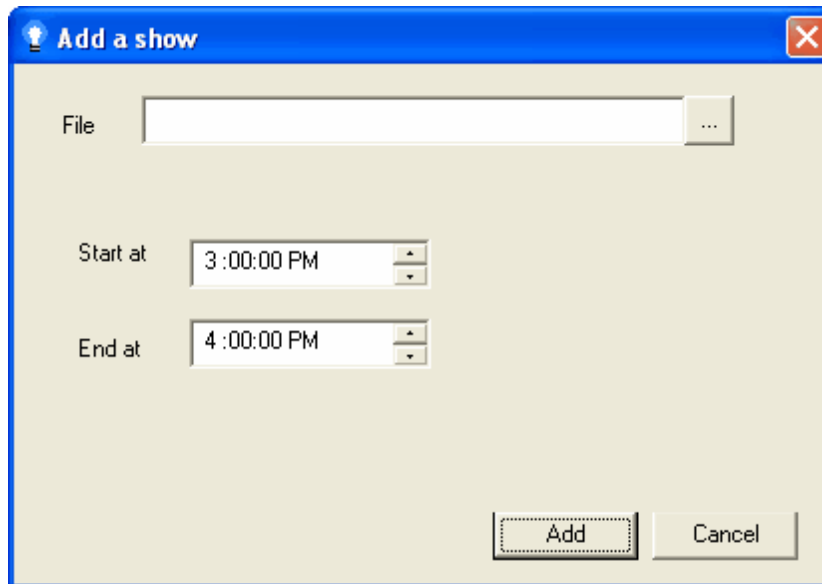

The Add Show dialog for the calendar schedule

Opening the Add Show dialog by clicking on an unscheduled area, rather than by using the Add button, has a couple advantages: First, it will automatically be populated with a start time and an end time based on where you had clicked. In the above example, the right-click was made at approximately 3:30 PM, and so the start and end times were automatically set to 3:00 PM and 4:00 PM.

Second, it automatically takes into account conflicts between the new show and any existing shows. For example, if a show had already been scheduled to start at 3:45 PM, the end time in the

above dialog would have automatically been set to 3:45 rather than 4:00. Note that this conflict checking is only done for other shows in the calendar schedule, not for shows in the weekly schedule; this is because the purpose of the calendar schedule is to easily override the weekly schedule for specific dates and times.

To add a new show using this dialog, simply select the show's filename (this is easiest using the "..." button, which will let you choose from the list of existing shows), select the start and end times, and "Add" (or "Cancel" if you wish to discard the new show).

Finally, remember to [save your changes](#) using the toolbar's "Save" button (or, if you wish to discard your changes, "Revert" instead).

Editing a Scheduled Show

No matter whether the [weekly schedule](#) or the [calendar schedule](#) is currently [displayed](#), you can edit a [scheduled show](#) by clicking on that show in the schedule, and selecting "Edit" from the popup menu:

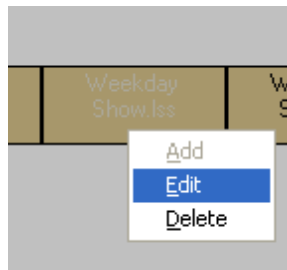

Editing an existing show

This will open a dialog very similar to the one you originally used to add the show. It will allow you to modify the name of the show file to be used, the start and end time, and, in the weekly schedule, the days of the week that the show will run on.

Finally, remember to [save your changes](#) using the toolbar's "Save" button (or, if you wish to discard your changes, "Revert" instead).

You cannot edit the contents of a show - such as the sequences it uses - from the [Schedule Editor](#). In order to do that, you need to use the [Show Editor](#).

Deleting a Scheduled Show

No matter whether the [weekly schedule](#) or the [calendar schedule](#) is currently [displayed](#), you can delete a [scheduled show](#) by clicking on that show in the schedule, and selecting "Delete" from the popup menu:

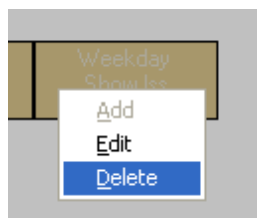

Deleting an existing show

Note that this does not actually delete the show - it only deletes it from the schedule. The show will still be available for editing with the [Show Editor](#), or for scheduling at some other time.

Finally, remember to [save your changes](#) using the toolbar's "Save" button (or, if you wish to discard your changes, "Revert" instead).

5.7 Simple Show Builder

The Light-O-Rama Simple Show Builder is an alternative to the [Show Editor](#) and the [Schedule Editor](#), allowing you to create [shows](#) and to [schedule](#) them to be played at certain times. While the Simple Show Builder is easier to use, the Show Editor and the Schedule Editor are more flexible and powerful.

The Simple Show Builder progresses, step by step, through a few screens:

First, a "[Welcome](#)" screen is displayed, giving some brief instructions on what you will need to have ready in order to use the Simple Show Builder.

Next, you are given a [choice of what type of device type](#) you want to use for your show.

Then, you can [select the sequences](#) that you want to use for the show.

Next, you can [pick the time or times that the show should run at](#).

If you chose to use an MP3 device, you will then be asked to [insert your SD card into your SD card reader/writer, and to tell the Simple Show Builder when you have done so](#). Your show will then be downloaded to your SD card.

Otherwise, you will be presented with a [final screen](#), showing some directions on how to enable the Show Player to run the show that you have just scheduled.

Welcome

The first screen in the [Simple Show Builder](#) shows a list of things that it would help to have ready before you use it. After you have these things ready, simply click "Next".



The Simple Show Builder's welcome screen

Choose the Device Type

The next screen in the [Simple Show Builder](#) allows you to select the type of device that you want to control your show. You can run it from your PC (using the [Light-O-Rama Show Player](#)), or any of a few types of Light-O-Rama MP3 devices. Choose the device you wish to use, and click "Next".



Select the device type that will control your show

Select Sequences

The [Simple Show Builder](#) will next ask you which [sequences](#) you wish to use in the [show](#). On the left is a list of your existing [musical sequences](#) (either those with 16 [channels](#), those with 32 channels, or all of your musical sequences, based on your choice of the radio buttons at the bottom).

Add a sequence to the show by highlighting it and then clicking the "Add" button; this will move the show from the left pane to the right pane, which is the list of sequences in your show. Similarly, remove one from your show by highlighting it and clicking "Remove".

The sequences will be played in the order that you list them, but you can change the order simply by clicking on the "Up" or "Down" arrow (on the right-hand side).

When you are satisfied with the sequences in your show and their order, continue by pressing the "Next" button.

Note that if any other than "Use a PC" is selected, only [effects](#) on [channels](#) that are set up to use the Regular Light-O-Rama [network](#) will be downloaded.

Note that only musical sequences can be scheduled using the Simple Show Builder. If you wish your show to have [animation sequences](#), you must instead use the [Show Editor](#) and the [Schedule Editor](#).

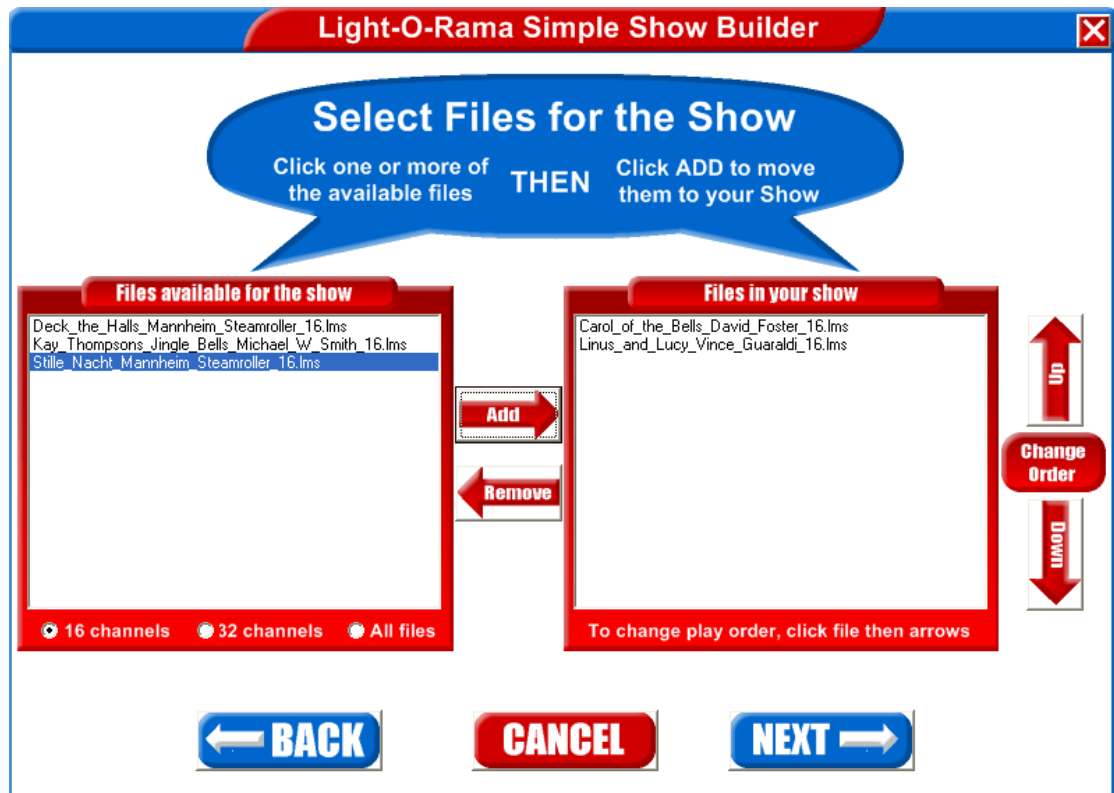

Select the sequences to be played in your show, and the order they will be played in

Choose the Times

The [Simple Show Builder](#) will then ask you to select the times at which you want your [show](#) to run. You can have different times for up to two different sets of days of the week. You can select any days you want to be in either set, but typically this is used to have your show played during different times on weekdays and weekends. Note that "weekends" here might mean "Friday and Saturday", rather than "Saturday and Sunday", since your show will probably be playing while it's dark out, and so "weekend" is really "the night before a weekend day". In fact, this is how the Simple Show Builder operates by default, but again, you can change this however you want.

After selecting the days of the week, select the start and end times for each.

Next, choose whether you want the show to run continuously, or once every hour or every half hour. If you select "continuously", then after all of its [sequences](#) have been played, the show will automatically start over with the first sequence; this will continue until the end time is reached. If, instead, you select "once every hour" or "once every half hour", the show will stop after its last sequence, and start again once every hour (or half hour), until its end time is reached.

When you are satisfied with the scheduled times, click "Next".

Light-O-Rama Simple Show Builder

Schedule When Your Show Plays

Select days for Regular Hours: Sun Mon Tue Wed Thu Fri Sat

Regular Start Time: 6:00PM Regular End Time: 10:00PM

Select days for Weekend Hours: Sun Mon Tue Wed Thu Fri Sat

On weekends you may want the show to run a little later

Weekend Start Time: 6:00PM Weekend End Time: 11:00PM

At Scheduled Times

- Run Continuously
- Once Every Hour
- Once Every Half Hour

← BACK **CANCEL** **NEXT →**

Select the times that you want the show to run at

Download to the SD Card

If you had asked the [Simple Show Builder](#) to control your [show](#) via a Light-O-Rama MP3 device, rather than via the [Show Player](#) on your computer, you will then be prompted to insert your SD card in your SD reader/writer. When you have done so, click the large "CLICK HERE to write the SD card" button, and wait for confirmation that your show has been written to the SD card.

The Simple Show Builder is then complete; simply move your SD card to the Light-O-Rama MP3 device, and the [sequences](#) that you selected will play at the times that you selected.



Download the show to your SD card

Finished

If you had asked the [Simple Show Builder](#) to control your [show](#) via the [Show Player](#) on your computer, rather than via a Light-O-Rama MP3 device, you will be presented with a final screen giving directions on how to enable the Show Player. After you have read and understood them, simply click "Finish", and your show will be [scheduled](#).

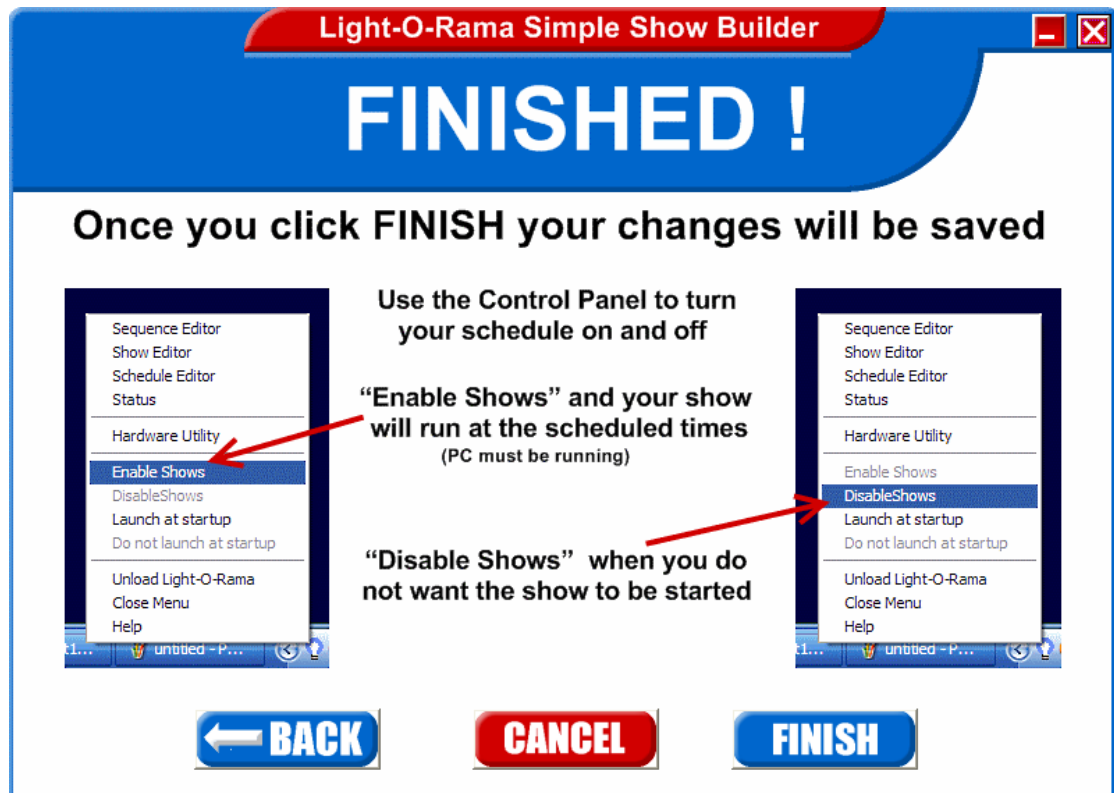

Final directions from the Simple Show Builder

5.8 Show Player

The Light-O-Rama Show Player is a program that runs behind the scenes, monitoring your [schedule](#) to see if a [show](#) should be playing at the current time, and if so, playing it.

To make sure that the Show Player is running, and therefore that your scheduled shows will be played, you first must ensure that the [Light-O-Rama Control Panel](#) is running. Next, right-click on the Light-O-Rama Control Panel's icon in your computer's system tray, and select "[Enable Schedule](#)" from the [popup menu](#). If "Enable Shows" is greyed out, that means that it is already selected.

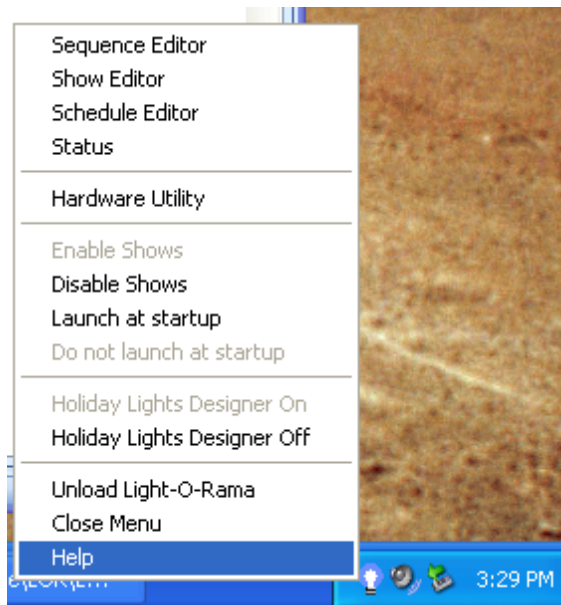

The Light-O-Rama Control Panel, with shows enabled

If the Light-O-Rama Control Panel is not running, or if "[Disable Shows](#)" is greyed out, your scheduled shows will *not* be played.

Note that only one source can control your lights at any time - either the Show Player, the [Sequence Editor](#), or the [Hardware Utility](#). So, if you try to enable the Show Player with one of the others running, you may be shown a message saying that you need to shut down the others before "Enable Shows" will work.

5.9 Comm Listener

The LOR Comm Listener is a program that runs in the background, allowing other programs (such as the [Sequence Editor](#) and the [Show Player](#)) to control [DMX devices](#). The Comm Listener must be running in order for those programs to control such devices.

The LOR Comm Listener is automatically started when the [LOR Control Panel](#) is started, unless DMX support is not configured (for example if the license level does not support it, or if no DMX listener port is specified in the Sequence Editor's [Network Preferences dialog](#)). Also, it is automatically shut down when the LOR Control Panel is shut down. So, to make sure that you can control your DMX devices, make sure that the LOR Control Panel is running.

5.10 Hardware Utility

The Light-O-Rama Hardware Utility is used to manage the [hardware](#) that you use to control your lights. This includes several types of controllers as well as other devices such as Light-O-Rama MP3 Directors and Light-O-Rama wireless devices.

Each of these types has a different tab in the Hardware Utility. When you start the Hardware Utility, the tab for Light-O-Rama controllers is displayed; to access one of the others, simply click its tab.

For details on each, please refer to the following sections:

- [Light-O-Rama Controllers](#)

- [Selecting a Comm Port](#)
- [Setting Unit IDs](#)
- [Configuring Units](#)
- [Testing Units](#)
- [Downloading Sequences](#)
- [Firmware Update](#)
- [Light-O-Rama MP3 Directors](#)
- [Light-O-Rama Wireless Devices](#)
- [Digital IO Boards](#)
- [X10 Controllers](#)
- [Test Console](#)

To run the Hardware Utility, select it from your computer's Start menu (Start / Light-O-Rama / Hardware Utility) or, if the [Light-O-Rama Control Panel](#) is currently running, right-click on its icon in your computer's system tray and select "Hardware Utility" from the popup menu.

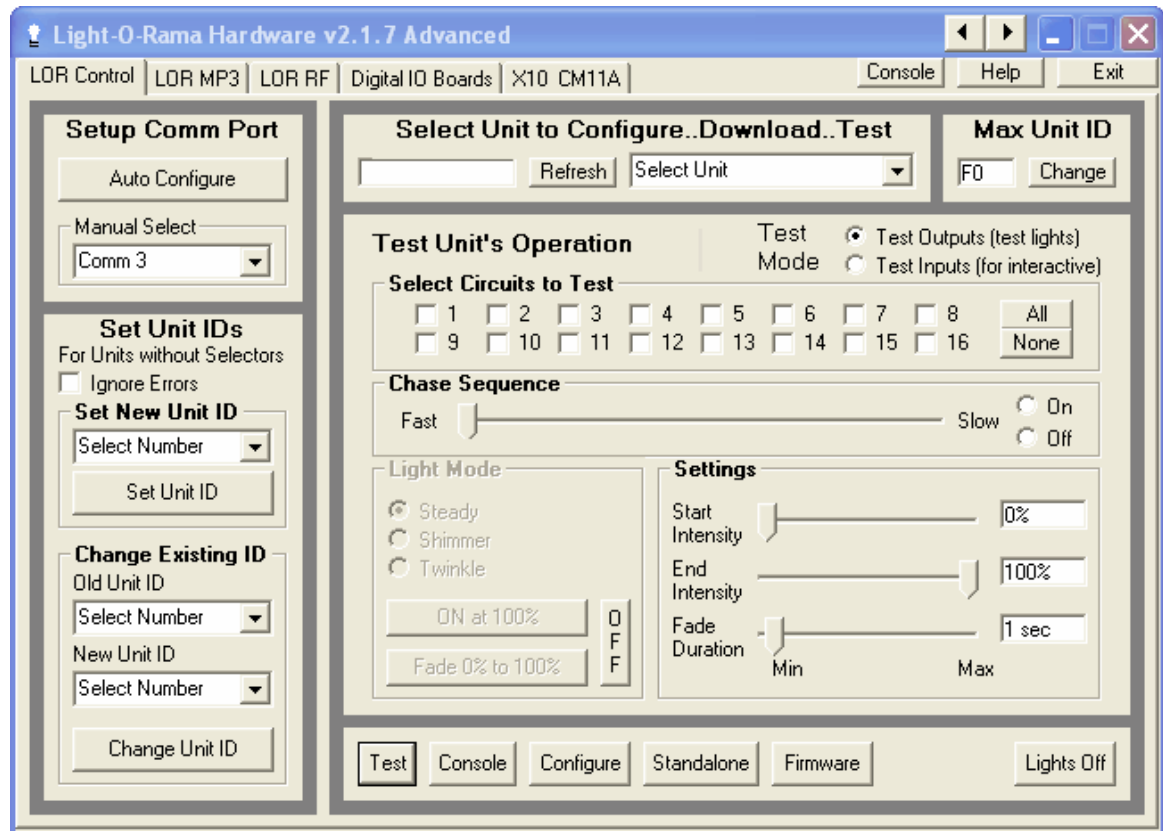

The Hardware Utility's tab for Light-O-Rama controllers

5.10.1 Light-O-Rama Controllers

The [Light-O-Rama Hardware Utility](#) can be used to configure and test [Light-O-Rama controllers](#) in several ways:

- [Selecting a Comm Port](#)
- [Setting Unit IDs](#)
- [Configuring Units](#)
- [Testing Units](#)
- [Downloading Sequences](#)

- [Firmware Updates](#)

To use these, select the Hardware Utility's tab labeled "LOR Control" (it is already selected by default when the Hardware Utility is started).

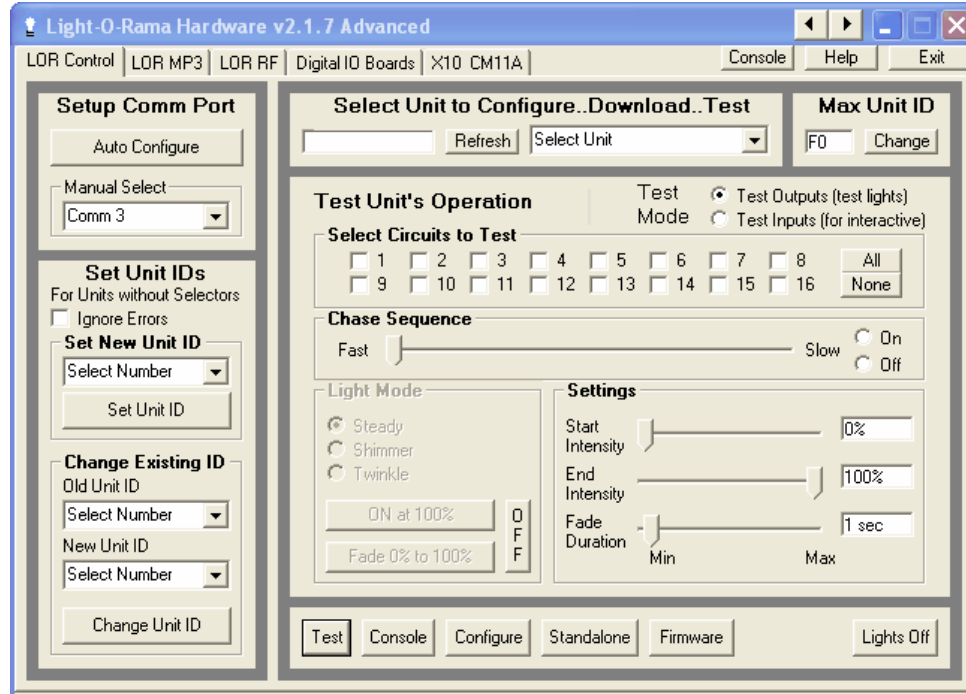

The Hardware Utility's "LOR Control" tab, for configuring and testing Light-O-Rama controllers

5.10.1.1 Selecting a Comm Port

The "Setup Comm Port" section of the [LOR Control tab](#) of the [Light-O-Rama Hardware Utility](#) is used to set which RS-232 comm port the Hardware Utility will use for [Light-O-Rama controllers](#).

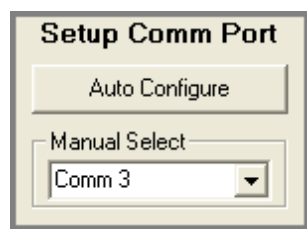

The Setup Comm Port section

While the [Sequence Editor](#) and [Show Player](#) can use up to four different comm ports simultaneously for Light-O-Rama controllers, the Hardware Utility only uses one at a time. By default, it will be set to use the port you have configured to be your "Regular" port (if you have done so); see "[Network Preferences](#)" in the Sequence Editor for details on how to set your Light-O-Rama ports.

Only comm ports 1 through 16 are supported in the Hardware Utility.

If you know the comm port that it should be using, you can simply select it from the "Manual Select" dropdown box. If you select a port other than your "Regular" port, the Hardware Utility will offer to automatically change your "Regular" port to be the one that you selected.

If you do not know the comm port to be used, you can ask the Hardware Utility can automatically detect it:

- Connect a Light-O-Rama controller to your PC, for example using an SC485 connector or a USB-RS485 adapter.
- Connect the controller to AC power, and turn it on.
- Click on the "Auto Configure" button.

The Hardware Utility should then automatically detect the comm port that you have hooked the controller up to. If it does not:

- Check the physical connection (such as cables and the SC485 connector).
- Check that the controller's power is on.
- Ensure that switches or jumpers on the controller are correct.
- Ensure that the correct type of cable is used.
- Retry the "Auto Configure" button.

If all of the above fails to find the port, then watch the controller's blinking LED light while manually selecting different comm ports from the list. Once a comm port is selected, wait about five seconds. If the LED stops blinking, then that is the correct port. If it does not stop blinking, try the next comm port in the list.

If this still does not determine the correct comm port, there may be a problem with the connector or the controller.

If "Auto Configure" does not work, but you were able to determine the comm port by manual selection, there may be a problem with the connector. Or, if your computer is an older PC or laptop, there may be a compatibility issue with the computer's communications drivers.

In any case, if you can get the unit's LED to stop blinking, then that controller will most likely work on your PC.

5.10.1.2 Setting Unit IDs

Each [Light-O-Rama controller](#) must have a unique assigned [unit ID](#), identifying this particular controller. The reason for this is that every Light-O-Rama controller in a network can see every [lighting command](#) message that is sent over the [network](#), not only the lighting commands sent for that controller. So, all of the commands contain a unit ID, and a controller only acts upon a command if the unit ID of the controller matches the unit ID of the message.

A unit ID is a two-character field. Each character can have any of the values 0, 1, 2, 3, 4, 5, 6, 7, 8, 9, A, B, C, D, E, and F. For example, a unit ID might be "03", "07", "25", "37", "6B", "C8", or "DA". However, certain values are reserved, and so not allowed (specifically, "00", and "F1" through "FF").

Some Light-O-Rama controllers have selector switches that allow you to directly set their unit IDs. In that case, simply use a small screwdriver (making sure that the unit is not attached to power) to dial the switches to the desired unit ID.

Other controllers do not have selector switches. To set the unit IDs of these controllers, you can use the [LOR Control tab](#) of the [Light-O-Rama Hardware Utility](#):

- [Connect the Unit to the Computer](#)
- [Select the Comm Port](#)

- [Set the ID of a New Unit](#)
- [Change the ID of an Existing Unit](#)
- [Troubleshooting](#)

Connect the Unit to the Computer

The first step in setting a [Light-O-Rama controller's unit ID](#) using the [Hardware Utility](#) is to connect the unit to the computer, for example using an SC485 adaptor or a USB-RS485 adaptor. Make sure that the selector switches are correctly set for the type of cable used (units are shipped ready to use [data cables](#)). Plug the unit into an AC outlet, and turn the unit on.

Select the Comm Port

After you have [connected the unit](#) to the computer, [select the comm port](#) that the [Hardware Utility](#) should use to communicate with the controller.

Set the ID of a New Unit

If this is a new unit that has not previously been assigned a [unit ID](#), use the "Set New Unit ID" section of the [LOR Control tab](#) of the [Hardware Utility](#). Simply select the unit ID you want to assign, and click the "Set Unit ID" button.

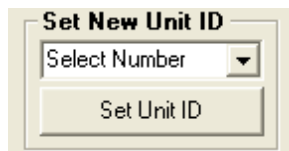

Setting the ID of a new unit

Change the ID of an Existing Unit

If you have previously assigned a unit ID to this unit, but want to change it, use the "Change Existing ID" section of the LOR Control tab of the Hardware Utility. Select the unit's current ID in the "Old Unit ID" list, and the unit ID that you want to change it to in the "New Unit ID" list. Finally, click the "Set Unit ID" button.

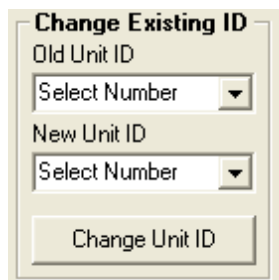

Changing a unit ID

If you do not remember the unit's current unit ID, or if the controller doesn't seem to be reacting to its current ID, you can change it to a new unit ID by selecting "Any Unit" in the "Old Unit ID" list. However, **be very careful**. If you select "Any Unit", then *all* units that are connected to the PC will have their unit IDs changed. So, make sure that you have only the one controller (whose unit ID you wish to change) connected.

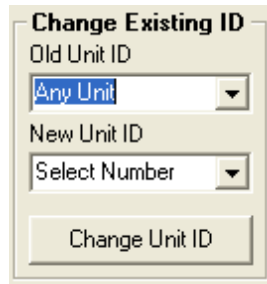

Changing a unit ID for "Any Unit"

Troubleshooting

If, while setting a [Light-O-Rama controller's unit ID](#), you receive an error saying that the unit cannot be located, the first thing to do is to check all connections and to [make sure that the correct comm port is selected](#). If the [Hardware Utility](#) still cannot locate the unit, check the Communication LED on the unit. When the unit is disconnected from the data cable the LED should blink; when it is connected and the Hardware Utility is running with the correct comm port selected, the LED should stop blinking, turning on steady.

If the Communications LED continues to blink regardless of the steps taken, then there may be a problem with the cable, the adaptor, the controller, or the PC's comm port.

If the LED stops blinking but you still get an error when attempting to set the unit ID, then there may be a problem with the adaptor or the controller, or the PC may have a communications driver that is not completely compatible with Light-O-Rama. However, you may still be able to set the unit ID by checking the "Ignore Errors" box and then trying to set the unit ID again. If you do check the "Ignore Errors" box, make sure that the unit ID has been set correctly by [running some tests](#) on the controller.

5.10.1.3 Configuring Units

Some [Light-O-Rama controllers](#), such as the MC-Px and CTBxxD units, have special options that can be configured. You can use the [LOR Control tab](#) of the [Hardware Utility](#) to do so, using the following steps:

- [Connect The Unit to the PC](#)
- [Select the Comm Port](#)
- [Select the Unit](#)
- [Choose "Configuration"](#)
- [Set the Minimum and Maximum Intensities](#)
- [Set the Input Channel Types](#)
- [Set the Port Type](#)
- [Configuring DIO32 Servos](#)
- [Configuring Cosmic Color Ribbons and Cosmic Color Bulbs](#)
- [Dimming Curves](#)
- [Update](#)

Connect the Unit to the PC

The first step is to connect the unit to the computer, for example using an SC485 adaptor or a USB-RS485 adaptor. Make sure that the selector switches are correctly set for the type of cable used (units are shipped ready to use [data cables](#)). Plug the unit into an AC outlet, and turn the unit on.

Select the Comm Port

After you have [connected the unit](#) to the computer, [select the comm port](#) that the [Hardware Utility](#) should use to communicate with the controller.

Select the Unit

After you have [connected the unit to the PC](#) and [selected the comm port](#), select the [unit ID](#) of the [controller](#) that you wish to configure: Hit the "Refresh" button, and the [Hardware Utility](#) will scan your [network](#) for connected units. You can then select the unit ID from the dropdown list. Alternatively, if you already know the unit ID, you could simply type it into the dropdown box, without hitting "Refresh" first; this is quicker, but has some drawbacks:

Depending upon the type of controller and the level of firmware, hitting "Refresh" may allow the Hardware Utility to automatically populate the configuration settings screen with the actual current configuration of the controller. Typing in the unit ID, without first hitting "Refresh", will not do this, and so the configuration settings screen will simply show default values, which may or may not be how the controller is currently configured.

Also, "Refresh" allows the Hardware Utility to figure out the type of the controller, which lets it know various things about how to interact with this controller specifically; for example, the maximum number of bytes in a [standalone sequence](#) varies with the type of controller. If you hit "Refresh", the Hardware Utility will know how many bytes this controller can handle, and so won't allow a larger sequence to be sent to the controller. Simply typing in the unit ID, without first hitting "Refresh", will not do this, and so the Hardware Utility may try to send a standalone sequence that is larger than the controller can deal with.

NOTE: Scanning the network may take some time. If you have set the unit IDs of your controllers to low values, you can use the "Max Unit ID" section to speed up this scan drastically. It is therefore a good habit to assign your controllers unit IDs starting at 01, and increasing sequentially through 02, 03, and so on.



The screenshot shows a software interface with two main sections. The left section is titled "Select Unit to Configure..Download..Test" and contains a text input field, a "Refresh" button, and a "Select Unit" dropdown menu. The right section is titled "Max Unit ID" and contains a text input field with the value "05" and a "Change" button.

Selecting the unit to configure

Choose "Configuration"

Next, click the "Configuration" button (near the bottom of the [LOR Control tab](#) of the [Hardware Utility](#)). This brings up configuration settings:

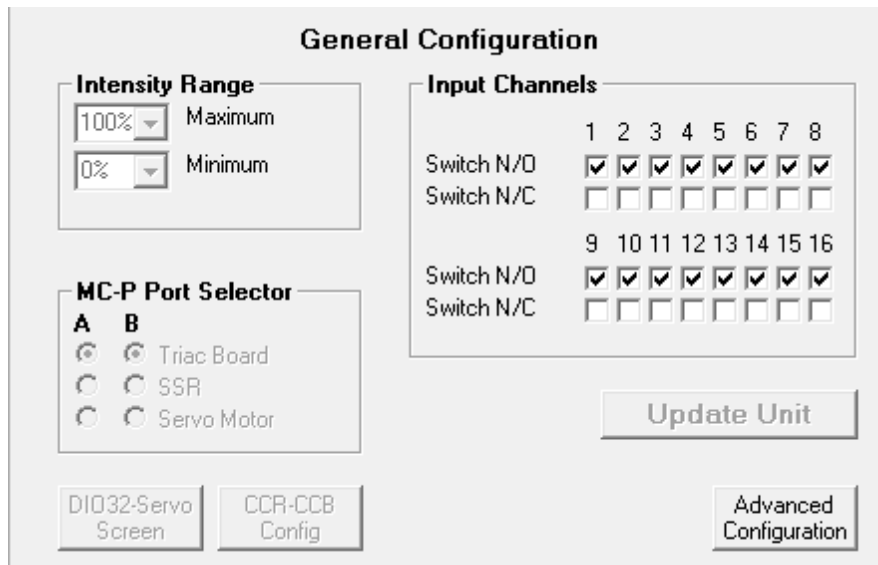

The configuration section of the LOR Control tab

Set the Minimum and Maximum Intensities

While active, the [controller](#) will not set its lights' intensities below the specified minimum. If, however, it loses communications with its director, it will turn them off (i.e. 0% intensity). The lights are not turned up to the minimum until the unit receives its first lighting command.

Setting a maximum intensity below 100% may be used to help prolong the life of bulbs, although there is an important exception: Retro LED C7 and C9 bulbs (also known as replacement LEDs) can be harmed by using them at any intensity *other* than 100% or 0%.

The initial values displayed in this section are read from the controller itself (although this is supported only for certain versions of firmware - your controller may need a [firmware update](#) in order to read the values from the controller).

These settings only take effect for [ports that are configured](#) as "Triac Board".



Setting the intensity range

Set the Port Type

The port type can be set to Triac Board, SSR, or Servo Motor. When set to Triac Board, dimming and fading are possible. When set to SSR, the unit will support SSRs with zero cross detectors. For the CTB08D controller, the two servo pins can be activated by setting Port B to Servo.

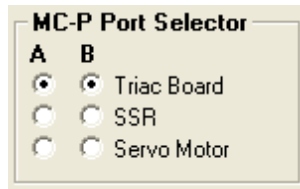

MC-P Port Selector

A B

Triac Board

SSR

Servo Motor

Setting the port type

Set the Input Channel Types

[Circuits](#) that are used for [interactive triggers](#) can be either normally open ("N/O") or normally closed ("N/C"). The current value for each circuit is read from the [controller](#) itself, and the value can be updated in the "Input Channels" section.

Not all versions of [firmware](#) support this feature; if your controller has not yet been updated with firmware that supports it, the circuit will be treated as normally open (which is also the default for versions of firmware that can support both).

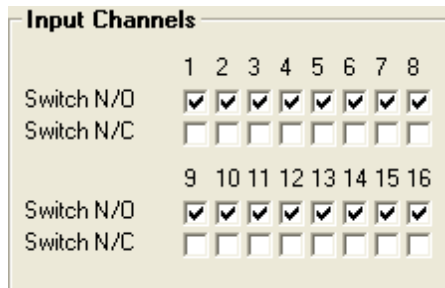

Input Channels

	1	2	3	4	5	6	7	8
Switch N/O	<input checked="" type="checkbox"/>	<input checked="" type="checkbox"/>	<input checked="" type="checkbox"/>	<input checked="" type="checkbox"/>	<input checked="" type="checkbox"/>	<input checked="" type="checkbox"/>	<input checked="" type="checkbox"/>	<input checked="" type="checkbox"/>
Switch N/C	<input type="checkbox"/>	<input type="checkbox"/>	<input type="checkbox"/>	<input type="checkbox"/>	<input type="checkbox"/>	<input type="checkbox"/>	<input type="checkbox"/>	<input type="checkbox"/>
	9	10	11	12	13	14	15	16
Switch N/O	<input checked="" type="checkbox"/>	<input checked="" type="checkbox"/>	<input checked="" type="checkbox"/>	<input checked="" type="checkbox"/>	<input checked="" type="checkbox"/>	<input checked="" type="checkbox"/>	<input checked="" type="checkbox"/>	<input checked="" type="checkbox"/>
Switch N/C	<input type="checkbox"/>	<input type="checkbox"/>	<input type="checkbox"/>	<input type="checkbox"/>	<input type="checkbox"/>	<input type="checkbox"/>	<input type="checkbox"/>	<input type="checkbox"/>

Setting the input channel types

Configuring DIO32 Servos

DIO32 devices can be set up to control servos; the [Hardware Utility](#) can be used to configure them by clicking the "DIO32-Servo Screen" button in the [Configuration](#) section. Doing so brings up the following:

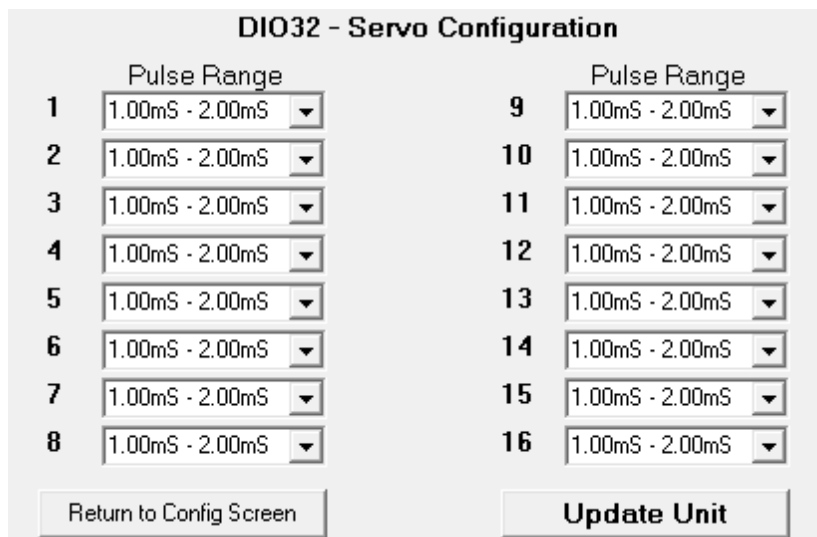

DIO32 - Servo Configuration

	Pulse Range		Pulse Range
1	<input type="text" value="1.00mS - 2.00mS"/>	9	<input type="text" value="1.00mS - 2.00mS"/>
2	<input type="text" value="1.00mS - 2.00mS"/>	10	<input type="text" value="1.00mS - 2.00mS"/>
3	<input type="text" value="1.00mS - 2.00mS"/>	11	<input type="text" value="1.00mS - 2.00mS"/>
4	<input type="text" value="1.00mS - 2.00mS"/>	12	<input type="text" value="1.00mS - 2.00mS"/>
5	<input type="text" value="1.00mS - 2.00mS"/>	13	<input type="text" value="1.00mS - 2.00mS"/>
6	<input type="text" value="1.00mS - 2.00mS"/>	14	<input type="text" value="1.00mS - 2.00mS"/>
7	<input type="text" value="1.00mS - 2.00mS"/>	15	<input type="text" value="1.00mS - 2.00mS"/>
8	<input type="text" value="1.00mS - 2.00mS"/>	16	<input type="text" value="1.00mS - 2.00mS"/>

DIO32 servo configuration options

For each [circuit](#), you can select the appropriate pulse width to be used for the servo attached to that circuit. There are at least two reasons why you might want to do this: First, some servos support different pulse widths than others; second, you might want to use this to limit the range of the servo.

The minimum value in the selected pulse width will be used whenever a 0% [intensity](#) is set on that circuit's [channel](#); the maximum value will be used whenever a 100% intensity is set. Regardless of the pulse width, 50% intensity always corresponds to 1.5 milliseconds.

Note that only sixteen circuits are displayed, though the DIO32 has 32 circuits. This is because its 32 circuits are spread among two [unit IDs](#). For example, the first sixteen circuits might be for unit ID 01, in which case the next sixteen would be for unit ID 02. Both sets of sixteen can be configured independently, by [selecting the appropriate unit ID](#). However, if you want to configure both, make sure to [update](#) the controller with your changes for one before proceeding to the other.

Configuring Cosmic Color Ribbons and Cosmic Color Bulbs

Cosmic Color Ribbons and Cosmic Color Bulbs have their own configuration options, unique to them. You can use the [Hardware Utility](#) to configure these options by clicking the "CCR-CCB Config" button in the [Configuration](#) section (note, though, that this button will be greyed out unless you have [selected a Cosmic Color Ribbon or Cosmic Color Bulb unit](#); you may have to use the Refresh button in order to let the Hardware Utility know about your Cosmic Color Ribbon or Cosmic Color Bulb). Doing so will bring up the following screen:

Cosmic Color Ribbon/Cosmic Color Bulb configuration options

For details on these options, please refer to your Cosmic Color Ribbon or Cosmic Color Bulb manual (a PDF of the CCR manual is available online at http://lightorama.com/Documents/CR150D_Man_Web.pdf). Here is a brief overview of each:

- **Unit ID Mode:** In "Normal" mode, the Cosmic Color device will be a single [unit ID](#), with 157 [circuit IDs](#). In "Legacy" mode, the Cosmic Color device will use up to ten sequential unit IDs (depending upon the configured resolution), with up to 16 circuit IDs for each unit ID.
- **Channel Mode:** In "Triples" mode, [channels](#) will be arranged red, green, blue, red, green, blue, and so forth. For example, circuit 1 is red for the first pixel; circuit 2 green for the first pixel;

circuit 3 blue for the first pixel; circuit 4 red for the second pixel; and so on. In "Sequential" mode, all red pixels will come first, then all green pixels, then all blue pixels.

- **Standalone Speed:** The speed at which a [standalone sequence](#) will run. A value of 8 is normal speed; higher values are faster, and lower values are slower.
- **Resolution:** The number of logical pixels that the Cosmic Color device will be. For example, setting it to 50 will give individual control over each of the 50 physical pixels, using 150 channels (one red, one green, and one blue for each pixel), while setting it to 1 will make all of the lights on the Cosmic Color device act as a single pixel, using three channels (red, green and blue).
- **Num of strings/ribbons:** The number of end-to-end connected strings or ribbons.
- **Flip String 1 / Ribbon:** Reverses the order of the pixels on the ribbon, or string 1 of the CCB. Thus, when unchecked, pixel 1 is nearest the controller, and when checked, pixel 50 is nearest the controller.
- **Flip String 2:** For a Cosmic Color Bulb, reverses the order of the pixels on string 2 of the CCB. This setting has no effect on CCRs.
- **DMX Mode:** Selects how the Cosmic Color device will appear in a DMX universe: just the RGB channels, just the Macro channels, or both.

After choosing the configuration options, make sure to [update the unit](#) with the new settings.

Dimming Curves

The [Hardware Utility's](#) Advanced Configuration screen can be used to set dimming curves for Gen3 [controllers](#), or for pre-Gen3 controllers that have Gen3 firmware installed. To get to the Advanced Configuration screen, click on the Advanced Configuration button in the [Configuration section](#) of the [LOR Control tab](#) of the Hardware Utility.

Dimming curves determine the output of a [channel](#) versus the intensity setting of that channel. For example, the On/Off only curve has the output set at 100% for intensity values greater than 50% (or DMX 128), and the output at 0% for any other intensity value.

Each channel can be configured for a specific dimming curve. Gen3 firmware comes with three curves: "LOR standard" (which is normal for incandescent lights), "Dim Curve01" (which is a good curve for LED Lighting), and "On/Off only" (which is best with loads such as strobe lights that should never be dimmed).

The LOR Standard and On/Off curves cannot be changed. Any other curves can be downloaded and updated on the controller. If a channel is set to use a dimming curve that is not present on the controller, then the channel will default to using LOR Standard.

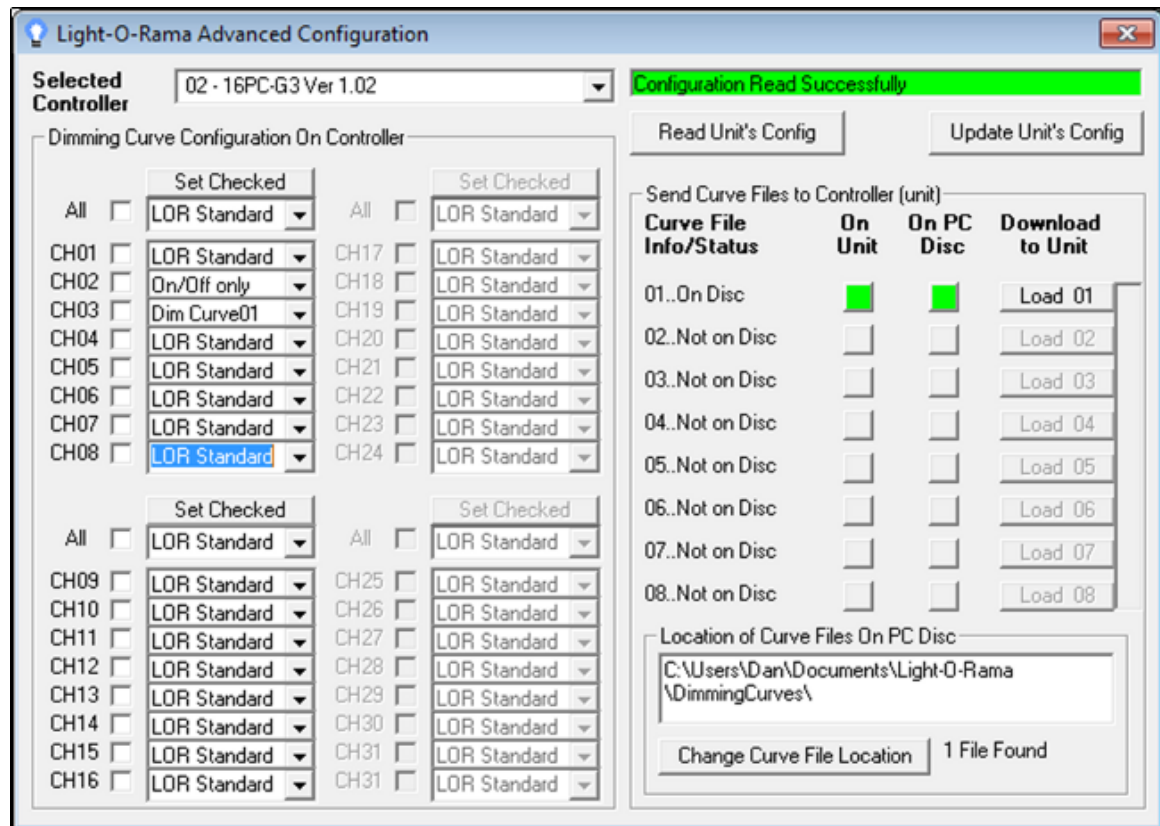

The Advanced Configuration screen

Update

When you have set the configuration settings to the value you want, click the "Update Unit" button to send the new configuration information to the [controller](#). Note: Doing so will update both the settings from the [main screen](#) and the settings from the [DIO32 servo screen](#).

After updating, hit "[Refresh](#)" again to reload the new settings from the controller into the Hardware Utility.

5.10.1.4 Testing Units

You can test the operation of [Light-O-Rama controllers](#) using the [LOR Control tab](#) of the [Hardware Utility](#), sending commands to turn lights on and off and to do other [effects](#), or generate [interactive triggers](#), by taking the following steps:

- [Connect the Unit to the Computer](#)
- [Select the Comm Port](#)
- [Select the Unit](#)
- [Test the Unit](#)

Connect the Unit to the Computer

The first step is to connect the unit to the computer, for example using an SC485 adaptor or a USB-RS485 adaptor. Make sure that the selector switches are correctly set for the type of cable used

(units are shipped ready to use [data cables](#)). Plug the unit into an AC outlet, and turn the unit on.

Select the Comm Port

After you have [connected the unit](#) to the computer, [select the comm port](#) that the [Hardware Utility](#) should use to communicate with the controller.

Select the Unit

After you have [connected the unit to the PC](#) and [selected the comm port](#), select the [unit ID](#) of the [controller](#) that you wish to use. If you know the controller's unit ID, you can simply type it into the dropdown box labelled "Select Unit". If not, use the "Refresh" button, and the [Hardware Utility](#) will scan your [network](#) for connected units. You can then select it from the dropdown list.

NOTE: Scanning the network may take some time. If you have set the unit IDs of your controllers to low values, you can use the "Max Unit ID" section to speed up this scan drastically. It is therefore a good habit to assign your controllers unit IDs starting at 01, and increasing sequentially through 02, 03, and so on.



The screenshot shows two panels from the Hardware Utility software. The left panel is titled "Select Unit to Configure..Download..Test" and contains a text input field, a "Refresh" button, and a "Select Unit" dropdown menu. The right panel is titled "Max Unit ID" and contains a text input field with the value "05" and a "Change" button.

Selecting the unit to use

Test the Unit

The "Test Unit's Operation" screen of the [LOR Control tab](#) of the [Hardware Utility](#) is the screen displayed by default when the Hardware Utility is opened. If it is not currently open, make sure you have selected the LOR Control tab, and then hit the "Test" button near the bottom of the Hardware Utility:

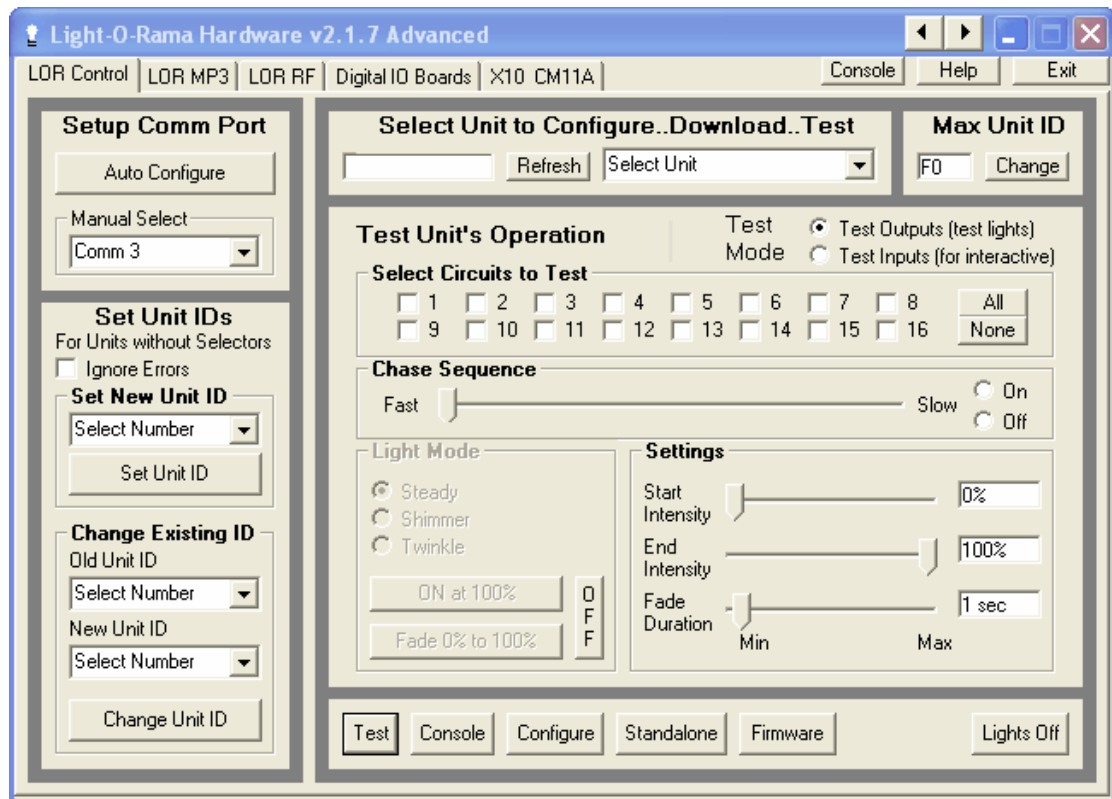

The testing section of the LOR Control tab

By setting the "Test Mode" appropriately, you can either [test output to the controllers](#) - that is, test that they can control your lights - or [test input from your controllers](#) - that is, test that they can generate [interactive triggers](#).

Test Outputs (test lights)

To test that your controllers can control your lights, select "Test Outputs (test lights)" as your "Test Mode".

After selecting the circuits that you wish to test (by checking their boxes in the "Select Circuits to Test" section), you can send a [lighting effect](#) command to those circuits by choosing the "Light Mode", "Start Intensity", "End Intensity", and "Fade Duration", and clicking on either the "ON", "OFF", or "Fade" buttons. **Note:** If "ON" is used, the intensity is specified via "End Intensity", not "Start Intensity".

Alternatively, the "Chase Sequence" section can be used to turn the selected [circuits](#) on and off in sequence.

Test Inputs (for interactive)

To test that your controllers can generate [interactive triggers](#), select "Test Inputs (for interactive)" as your "Test Mode".

Select the circuits that you want to test. When you trip a trigger for one of those [circuits](#), it should show up as red in this screen.

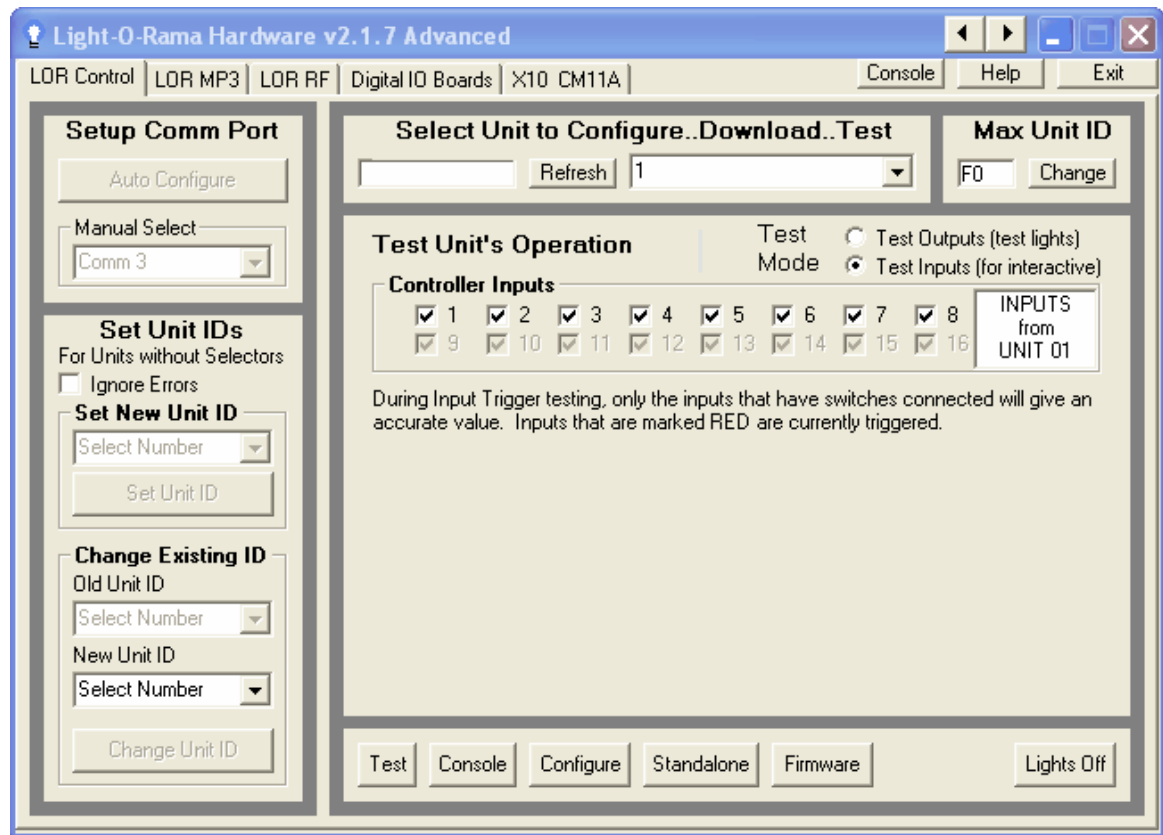

The input testing section of the LOR Control tab, with no circuits tripped

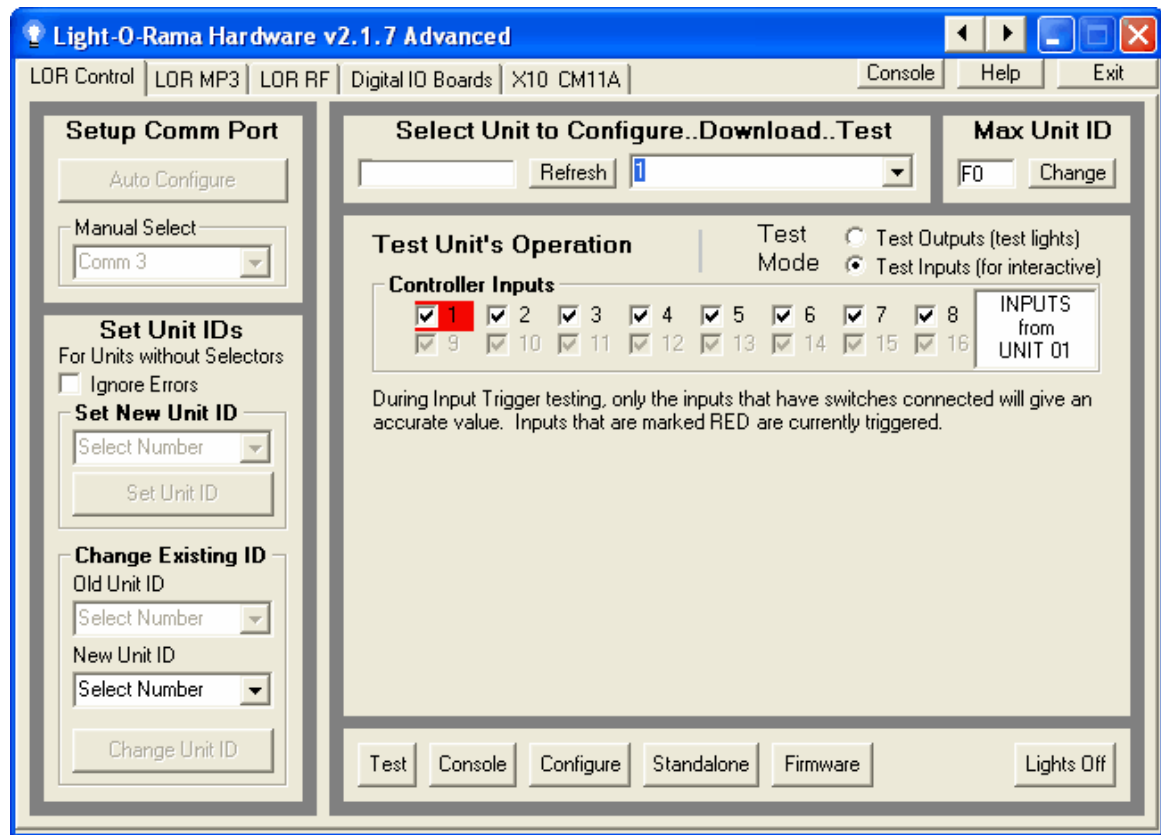

The input testing section of the LOR Control tab, with circuit 1 tripped

5.10.1.5 Downloading Sequences

The Standalone Sequence Downloader section of the [LOR Control tab](#) of the [Light-O-Rama Hardware Utility](#) can be used to send an [animation sequence](#) to a [Light-O-Rama controller](#), which can later run that sequence independently, in "standalone" mode, without being hooked up to a computer running [Light-O-Rama software](#).

When a unit runs a [sequence](#) in standalone mode, it not only executes the [lighting commands](#) in the sequence that are for that controller itself, but also, if the sequence contains any commands for other units, it will transmit them to the other units that it is connected to. In this way, a single controller can be downloaded with a sequence, and act as a "director" for several linked controllers.

It is important that only one controller in any mutually connected group act as a director. Downloading sequences to two separate controllers that are hooked up in a mutually connected group will have undesired results, as the commands transmitted by the two will interfere with each other. Similarly, it is important not to also control sequences from your computer while you have a controller hooked up to it acting in standalone mode, for the same reason.

Normally, the controller will execute the standalone sequence any time that it is powered on. However, some controllers have internal clocks that allow the standalone sequence to be scheduled to run during a particular timeframe.

Note: The CTB08 controller does not have transmit capability in standalone mode.

To download a sequence to a controller to be used in standalone mode, take the following steps:

- [Create the Sequence](#)
- [Connect the Controller to the PC](#)
- [Select the Comm Port](#)
- [Select the Unit](#)
- [Download the Sequence](#)

You can also use this section of the Hardware Utility to [choose when the sequence will run](#) (for controllers that support this), to [remove the standalone sequence from a controller](#), and to [test a standalone sequence](#).

To get to the Standalone Sequence Downloader screen, make sure that you are in the [LOR Control tab](#) of the Hardware Utility, and then click on the "Standalone" button.

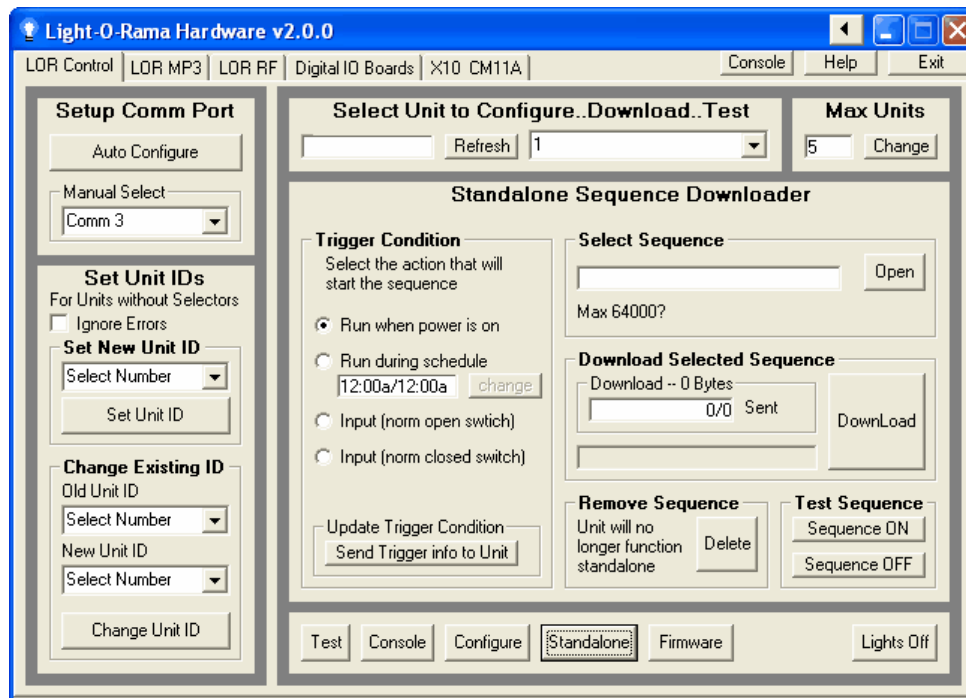

The Standalone Sequence Downloader section of the Hardware Utility

Create the Sequence

Using the [Sequence Editor](#), create an [animation sequence](#). Only animation sequences - not [musical sequences](#) - can be downloaded for standalone mode. When you create the [sequence](#), you must assign [unit IDs](#) and [circuit IDs](#) to the [channels](#), as normal.

Some [controllers](#) have very little storage space for sequences. Because size is a limiting factor, you should consider the following tips to keep your sequence's size at a minimum:

- [Fade](#) commands take up the most space.
- The least space is used when all lights on a controller are at either 100% or 0% intensity.
- When possible, place similar commands at the same time. For example, if you turn one circuit of a controller off and then, a tenth of a second later, turn another circuit on the same controller off, that will take about twice as much space as would turning both of them off at the same time.
- Use [loops](#) whenever possible.

- Different types of controllers have different maximum sequence sizes; controllers such as the CTB08 have little space and can handle only very simple animations.

Also, sequences to be used in standalone mode have some limitations:

- The sequence must contain only one [track](#).
- The sequence should only contain commands for controllers on a single [network](#); unexpected results may occur if you have more than one network listed in the sequence.
- [Timings](#) are only supported on tenth-of-a-second boundaries (for example, 1 second, 1.1 seconds, 1.2 seconds). If any timings in the sequence are at some centisecond other than a tenth-of-a-second boundary (for example, 1.15 seconds), they will be considered to be at the next tenth-of-a-second boundary.
- Depending on the device type, between 1 and 10 loop levels may be supported.
- Loop speed modification is not supported, and will be ignored.

Connect the Controller to the PC

Connect the unit to the computer, for example using an SC485 adaptor or a USB-RS485 adaptor. Make sure that the selector switches are correctly set for the type of cable used (units are shipped ready to use [data cables](#)). Plug the unit into an AC outlet, and turn the unit on.

Select the Comm Port

After you have [connected the unit](#) to the computer, [select the comm port](#) that the [Hardware Utility](#) should use to communicate with the controller.

Select the Unit

After you have [connected the unit to the PC](#) and [selected the comm port](#), select the [unit ID](#) of the [controller](#) that you wish to use. If you know the controller's unit ID, you can simply type it into the dropdown box labelled "Select Unit". If not, use the "Refresh" button, and the [Hardware Utility](#) will scan your [network](#) for connected units. You can then select it from the dropdown list.

NOTE: Scanning the network may take some time. If you have set the unit IDs of your controllers to low values, you can use the "Max Unit ID" section to speed up this scan drastically. It is therefore a good habit to assign your controllers unit IDs starting at 01, and increasing sequentially through 02, 03, and so on.



Selecting the unit to use

Download the Sequence

Choose the [animation sequence](#) you wish to download using the "Open" button in the "Select Sequence" section, and then download it using the "DownLoad" button in the "Download Selected Sequence" section:

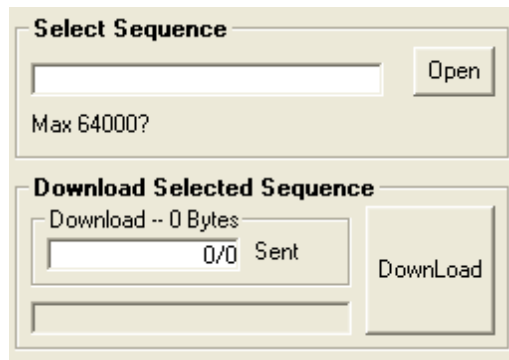

Selecting and downloading the sequence

If you do not see this in the [Hardware Utility](#), make sure that you are on the [LOR Control tab](#), and click on the "Standalone" button near the bottom.

Scheduling the Sequence

Some [Light-O-Rama controllers](#) can schedule the downloaded [sequence](#) to run at certain times or in certain conditions (those that cannot will run the sequence continually whenever powered on). To schedule when it will run, use the "Trigger Condition" section:

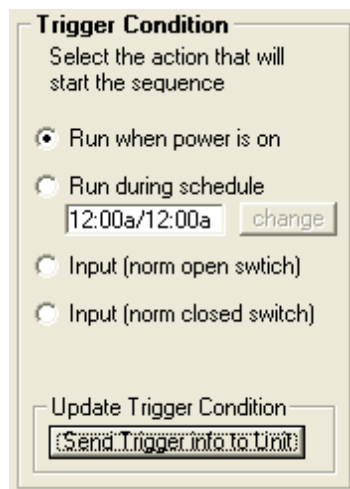

Scheduling the sequence

Select the condition you want to start the sequence, and click "Send Trigger info to Unit".

If you do not see this in the [Hardware Utility](#), make sure that you are on the [LOR Control tab](#), and click on the "Standalone" button near the bottom.

Note: If you choose to use specific scheduled times, the clock on the controller is set to the current time according to your computer. Make sure that the time on your computer is correct.

Removing the Sequence

To remove a downloaded [sequence](#) from a standalone [controller](#), use the "Delete" button in the "Remove Sequence" section:

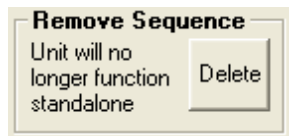

Removing a sequence

Note: This does not *actually* remove the sequence from the controller; rather, it makes it so that the controller will no longer play the sequence. So, if you later decide to use the sequence again, you can simply [reschedule the sequence](#) to run, rather than [downloading the sequence](#) again.

If you do not see this in the [Hardware Utility](#), make sure that you are on the [LOR Control tab](#), and click on the "Standalone" button near the bottom.

Testing the Sequence

After downloading a [sequence](#) to a [controller](#) to be used in standalone mode, it is recommended that you test the sequence, using the buttons in the "Test Sequence" section. To start the sequence, click "Sequence ON"; to stop it, click "Sequence OFF".

Note that the "Sequence OFF" button will stop the sequence even if it was started automatically (by powering on or by schedule, as opposed to via the "Sequence ON" button).

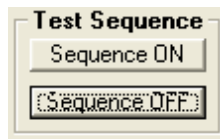

Testing the sequence

If you do not see this in the [Hardware Utility](#), make sure that you are on the [LOR Control tab](#), and click on the "Standalone" button near the bottom.

5.10.1.6 Firmware Updates

The Firmware Update section of the [LOR Control tab](#) of the [Hardware Utility](#) can be used to send new firmware to [Light-O-Rama controllers](#). A controller's firmware has a similar purpose to the operating system on your computer (such as Windows XP or Windows Vista): The operating system on your computer is used to run other programs that you load on the computer, such as [Light-O-Rama](#). The firmware on a Light-O-Rama controller is used to execute the commands to control the lights and run standalone sequences.

From time to time, new versions of firmware will become available. In general, unless the new version of firmware has a new feature that you need to use, you should not update the firmware.

If you do wish to update the firmware of a controller, do so using the following steps:

- [Select the Unit](#)
- [Select the Firmware File](#)
- [Download the Firmware](#)

If any problems are encountered, please see "[Troubleshooting](#)".

To get to the Firmware Update section of the Hardware Utility, make sure that you are in the LOR Control tab, and click the "Firmware" button (near the bottom).

The Firmware Update section of the Hardware Utility

Select the Unit

It is recommended that only one [controller](#) be connected to the computer when updating firmware. Units can have firmware updated when more than one is attached to the computer, but if you choose to do this, make sure that "Selected unit listed above" is selected, and make sure that the proper unit is selected in the "Select Unit to Configure.. Download.. Test" section (above the "Firmware" section).

If you instead use the recommended method of having only a single controller attached to the PC during a firmware update, choose "Only one unit is connected".

To update the firmware of a Light-O-Rama MP3 Player or a Light-O-Rama Wireless Unit, select the matching entry in the "Select Unit" section.

Selecting the unit

Select the Firmware File

Use the "Open" button to select the firmware file that you wish to send to the [controller](#). The "Open" button starts in your Light-O-Rama base directory; the firmware files are typically located in the "Firmware" subdirectory.

Select the latest version of firmware for the unit being updated. The names of the firmware files correspond with the names of the controllers.

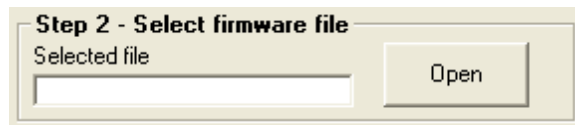

Selecting the firmware file

Download the Firmware

Finally, start the download by pressing the "Download" button. The progress bar will provide you with an update.

If you encounter any problems, please see "[Troubleshooting](#)".

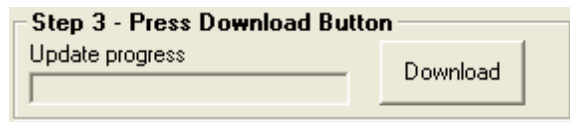

Starting the download

Troubleshooting

If the download does not start within 15 seconds of hitting the "Download" button, check that the unit is powered and properly connected to the PC. If all else fails, power the unit on and off **after you click the download button and the PC is attempting to start the download.**

5.10.2 Light-O-Rama MP3 Directors

The LOR MP3 tab of the [Light-O-Rama Hardware Utility](#) can be used to download [musical sequences](#) to a Light-O-Rama MP3 director (such as an "LOR1602W with Show Director and MP3 Player"), and schedule when those sequences should be played.

Up to nine separate shows can be downloaded to an MP3 director.

For details, please refer to the following sections:

- [Scheduling/Show Options](#)
 - [Old Firmware](#)
 - [Select When Show Plays](#)
 - [Select How Show Plays](#)
- [MP3 Player Showlist](#)
- [Download the Show](#)
- [Set the Time](#)

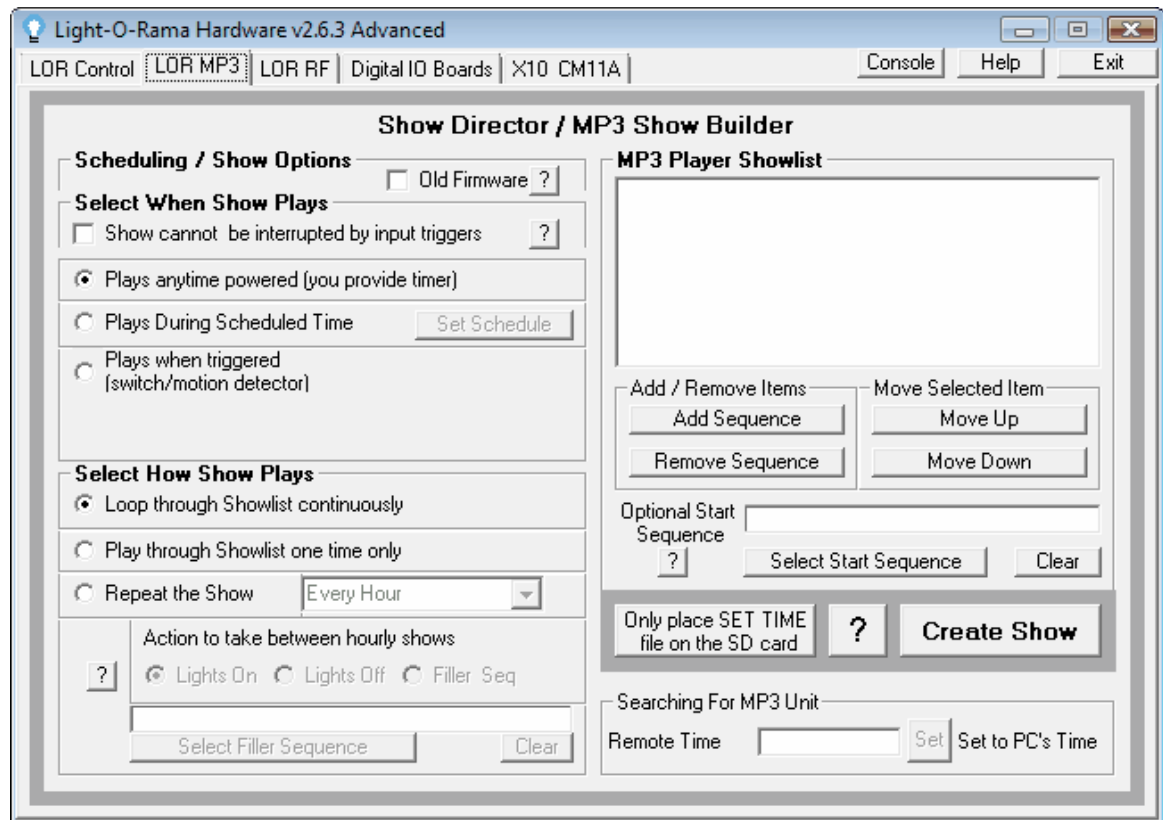

The LOR MP3 tab of the Hardware Utility

Scheduling/Show Options

This section allows you to select various options about the show:

- [Old Firmware](#)
- [Select When Show Plays](#)
- [Select How Show Plays](#)

Old Firmware

If your MP3 unit has the original firmware (Version 1.0) then you must check this box. To determine if the unit has this old version of firmware, watch the LEDs when you apply power. Newer versions of firmware will chase the LEDs briefly when power is first applied. The Old version of firmware will not perform the chasing of the LEDs.

New versions of firmware will provide you with many new scheduling features. It is recommended that if you [update your firmware](#) if you want these additional features.

Select When Show Plays

This section gives three main options for when the show will play: "plays anytime powered", "plays during scheduled time", and "plays when triggered". Additionally, you can specify that the show cannot be interrupted by input triggers, even if other shows are set up to start on those triggers.

Selecting "plays anytime powered" will cause the show to run whenever the MP3 director is powered

on.

Selecting "plays during scheduled time" allows you to specify a time or times when the show should play. Up to nine shows can be downloaded to a controller, and each will be assigned a number between 1 and 9. If two shows are scheduled for the same time, the lower numbered show will be played.

Selecting "plays when triggered" will cause the show to start whenever some external trigger happens (such as a circuit being closed or a motion detector being tripped). If you choose this option, you will be prompted to select the trigger's switch number (up to six switches are supported), and whether the switch is normally open or normally closed.

A normally open switch has its contacts open until you activate it, at which point they close; a normally closed switch has its contacts closed until you activate it, at which point they open. Most switches are normally open; motion detectors, however, are typically normally closed. This is because they are often used in security systems, where it is important to notice that a wire has been cut.

Select How Show Plays

In this section, you can choose whether the show should loop continuously (that is, when it finishes playing the last sequence in its list, it will start over at the first), or only one time, or every so often (every hour, half hour, fifteen minutes or ten minutes).

If you choose to play the show every so often, you will also be prompted for what the lights should do in between. You can choose to have all your lights on, or off, or else use an [animation sequence](#) as a "filler" that will play continuously during the time in between.

MP3 Player Showlist

You can add [musical sequences](#) to the show by clicking the "Add Sequence" button. To remove one, click on it to highlight it, and then click the "Remove Sequence" button.

The sequences will be played in the order listed. You can change the order by clicking on a sequence to highlight it, and then clicking "Move Up" or "Move Down".

Sequences with [subsequences](#) cannot be added to the showlist.

Optionally, you can also specify a "start sequence", which will be played once and only once every time the show starts up, before the other sequences. This is most useful if you selected that the show should loop continuously. For example, a show with a start sequence and three sequences in the showlist will, when "loop continuously" is turned on, first play the start sequence, then the first sequence of the showlist, then the second, then the third, and then back to the first in the showlist - *not* back to the start sequence.

Both musical sequences and [animation sequences](#) can be used as start sequences.

Note that only [effects](#) from [channels](#) set up to use the Regular Light-O-Rama [network](#) will be downloaded; those on auxiliary networks will not.

Download the Show

When you have selected the show's options and the [sequences](#) to be played, you can download the show to an SD card (which can later be placed into the MP3 director). Make sure that you have your SD card reader/writer hooked up to your PC, and click on the "Create Show" button. This brings up a final options screen:

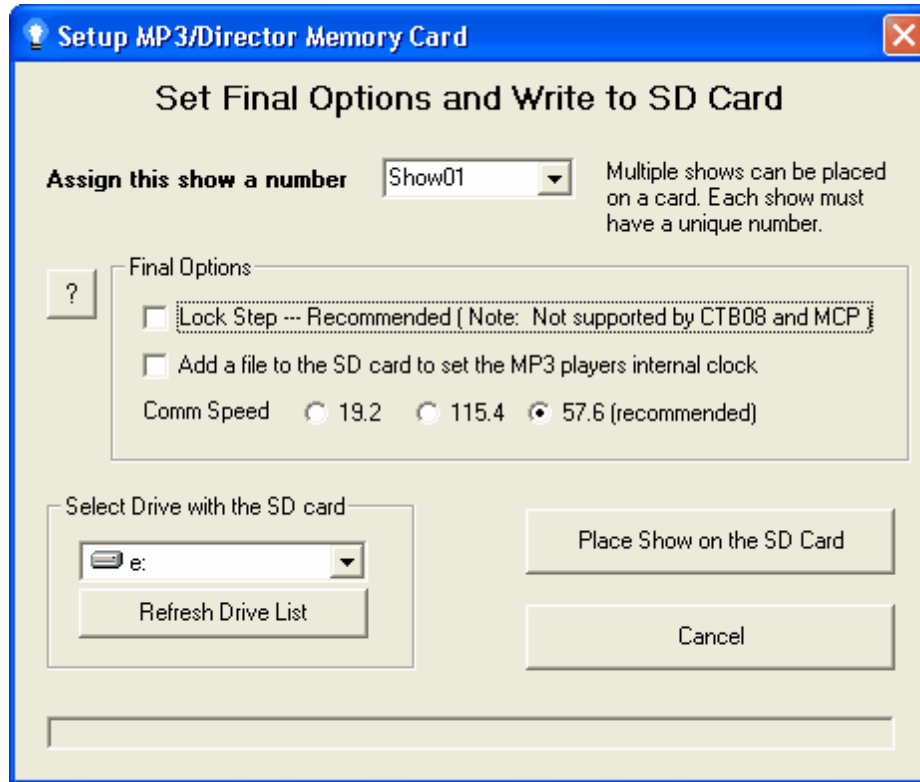

The final options for downloading a show to the SD card

On this screen, first select the show number that you want to use for this show. Each show on a card must have a unique number assigned. If multiple shows are scheduled at the same time, the lowest numbered show will take priority.

If you have a very large display, selecting "lock step" may help the different controllers used in the display react with a higher degree of synchronization. This is not supported on all controller types, and the level of firmware in the controllers must be 3.0 or higher.

If you wish to add a file to the SD card to set the MP3 director's internal clock, check the box that says so. Note that there are also [other ways to set the director's clock](#).

Select the communications speed that will be used to broadcast lighting commands. The recommended setting (57.6) will suffice for many users' displays. If you have many controllers that are far distances apart, a slower speed may help; if your sequences use many rapid lighting commands, a faster speed may help.

Next, select the drive that contains your SD card, and click "Place Show on the SD Card". After this completes, you can move the SD card to your MP3 director.

Set the Time

If any of your shows are set up to run on schedules, it is important to set the MP3 director's clock appropriately. There are several ways to do this:

First, you can directly hook your MP3 director up to your PC, and click on the "Set to PC's time" button (in the lower right-hand corner of the LOR MP3 tab).

If you cannot (or do not wish to) hook the MP3 director up to your PC, you can instead create a "time file" to be placed on an SD card. The first time that SD card is placed in the MP3 director, the director's clock will be set to the time specified in the time file (which you can choose, so that you have enough time to move the card from your PC to your MP3 director).

There are two ways to build a time file: First, you can click on the "Only place SET TIME file on the SD card"; this will create a time file and download it, without downloading a show as well. Second, when you create a show, during the final options dialog, you can request that a time file be created and downloaded along with the show.

Finally, you can manually set the time on an MP3 director. See the director's user's guide for details.

5.10.3 Light-O-Rama Wireless Devices

The LOR RF tab of the [Light-O-Rama Hardware Utility](#) can be used to configure Light-O-Rama wireless devices (such as the Easy Light Linker).

When using this tab, make sure that only a single wireless device is in the daisy-chained network hooked up to the PC.

For details, please see the following sections:

- [Frequency](#)
- [Speed](#)
- [Power Level](#)
- [Stream Data](#)
- [Get Current Configuration](#)
- [Set Defaults](#)
- [Update Configuration](#)

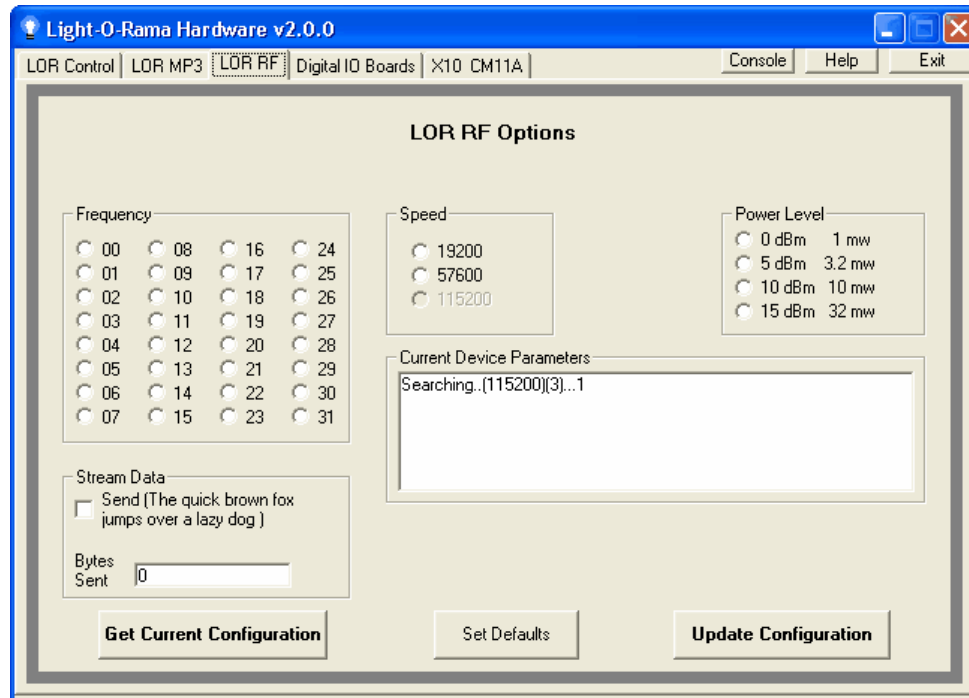

The LOR RF tab of the Hardware Utility

Frequency

Use this section to control the frequency used by the wireless device. Note that the transmitter and any receivers for it must be set to use the same frequency.

You can also use this to set the frequencies of two different transmitters to different values, so that they will not interfere with each other; these different transmitters can then be placed far apart from each other, effectively increasing the range of your wireless network.

Finally, some other wireless source in your area may interfere with Light-O-Rama's wireless communications at certain frequencies, so if you notice problems with the controllers hooked up to your wireless devices, try changing the frequency that is used.

If you change this setting, make sure to click the [Update Configuration button](#) so that the change will be sent to the wireless device currently hooked up to the PC.

Speed

Use this section to control the communications speed used by the devices. The faster speed is typically the better, allowing more frequent lighting effects, unless your controllers are separated over large distances. In that case, if you notice problems with the higher speed, try changing to the lower speed.

Note that a transmitter and its receivers must use the same speed.

If you change this setting, make sure to click the [Update Configuration button](#) so that the change will be sent to the wireless device currently hooked up to the PC.

Power Level

If your transmitter and receivers are physically close to each other, using too much power might cause unintended effects. If you notice this, try setting a lower power level.

If you change this setting, make sure to click the [Update Configuration button](#) so that the change will be sent to the wireless device currently hooked up to the PC.

Stream Data

This section continuously streams data. This is mostly for internal testing purposes, and it is unlikely that you will need to use this.

Get Current Configuration

Clicking this button will retrieve the settings (such as frequency) from the wireless device currently hooked up to the PC, and display them in the "Current Device Parameters" section.

Set Defaults

Clicking this button will reset the settings (such as frequency) of the wireless device currently hooked up to the PC back to their factory defaults.

Update Configuration

After you have changed the frequency, speed, or power level, click this button to send the changes to the wireless device currently hooked up to the PC.

5.10.4 Digital IO Boards

The Digital IO Boards tab on the [Light-O-Rama Hardware Utility](#) can be used to determine if Light-O-Rama can properly communicate with [digital IO boards](#) (including [BSOFT digital IO boards](#)) installed on your computer. In order to use these boards with Light-O-Rama, your computer must have the [Universal Library and InstaCal](#) installed.

To get a list of the boards that Light-O-Rama can find installed on the PC, click the "Refresh List" button. Once a list of boards appears, you can select a board to test. If the board is a BSOFT digital IO board, make sure that you check the appropriate checkbox.

After a board has been selected, you can test either individual pins on the board, or chase through all pins.

If you cannot control the board using the Hardware Utility, then you will not be able to control the board using any Light-O-Rama software, including the [Sequence Editor](#) or the [Show Player](#).

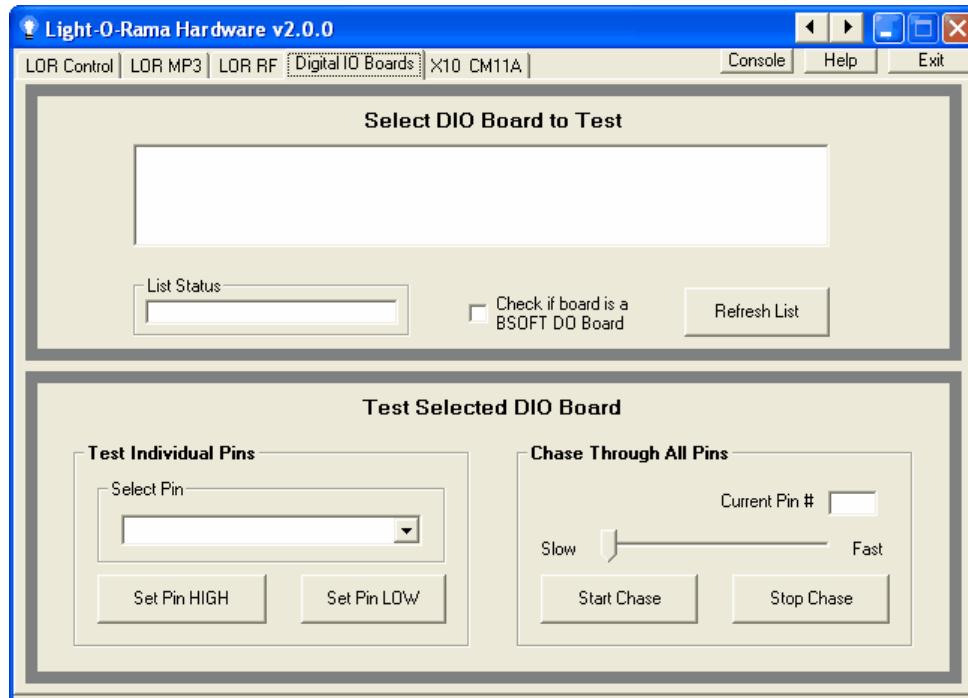

The Digital IO Boards tab of the Hardware Utility

5.10.5 X10 Controllers

Light-O-Rama can control industry standard X10 modules using CM11A [X10 controllers](#) (available for purchase at a variety of online stores). The X10 CM11A tab of the [Light-O-Rama Hardware Utility](#) can be used to test the connection and functionality of such controllers.

To do so, first connect the controller to a serial port, using the cable supplied with the CM11A.

Select the port that you believe the CM11A to be on in the "Select CM11A Port" dropdown list, and click on the "Init Unit" button. In the status window above the port selection dropdown list, you will see if the unit has been located on the selected port. **Note:** Occasionally there will be a false report of a CM11A being located on comm ports that are actually internal modems. This is generally Comm 3.

Select the house code and unit number of the controller, and test the unit using any of the "On", "Off", "Fade Down" and "Fade Up" buttons.

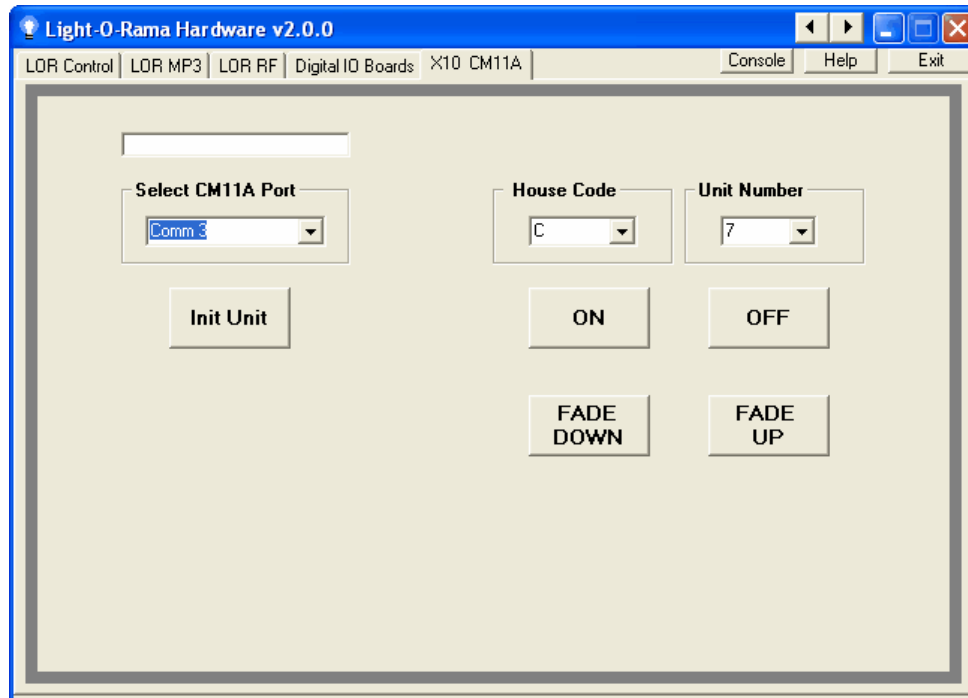

The X10 CM11A tab of the Hardware Utility

5.10.6 Test Console

Clicking on the "Console" button of the [Light-O-Rama Hardware Utility](#) opens the Test Console. The Test Console can be used to test standard Light-O-Rama controllers, or to configure and test Light-O-Rama iDMX-1000 DMX interface.

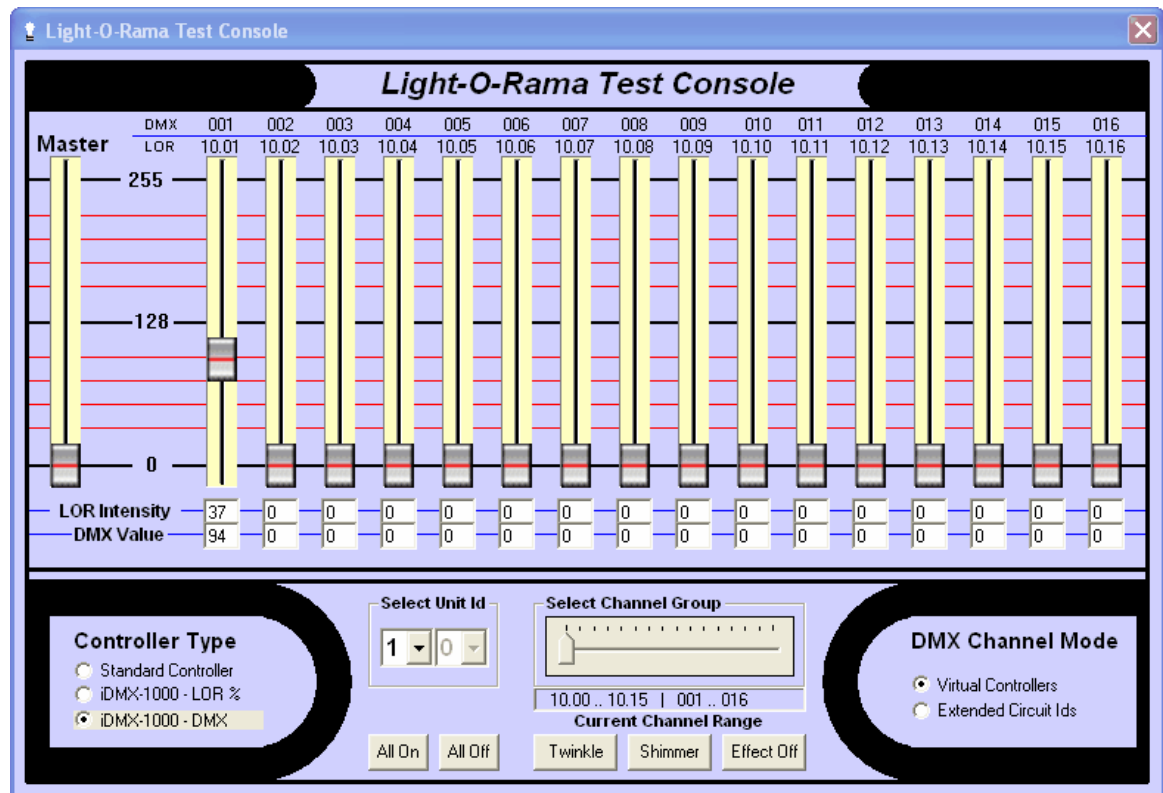

The Test Console of the Hardware Utility

Controller Type

Use this section (in the lower left) to choose whether to use a test a standard Light-O-Rama controller or to configure and test a Light-O-Rama DMX interface. In the latter case, you can choose between the ability to send any of 101 different intensities, from 0 to 100 ("LOR %" mode), or the ability to send any of 256 different intensities ("DMX" mode).

DMX Channel Mode

This section (in the lower right) is available only if the [controller type](#) is set to "iDMX-1000 - LOR %" or "iDMX-1000 - DMX". It allows you to choose how to map Light-O-Rama channels to DMX channels.

NOTE: Only "Virtual Controllers" is currently supported. "Extended Circuit IDs" will be supported in a future release.

In "Virtual Controllers" mode, the DMX interface is treated as sixteen separate Light-O-Rama controllers each having its own unit ID and each with sixteen circuits, for a total of 256 channels. These 256 channels are each mapped to an individual DMX channel.

In "Extended Circuit IDs" mode (which is *not* currently supported), the DMX interface will be treated as a single Light-O-Rama unit ID, but can individually address all 256 circuits (whereas currently a single Light-O-Rama unit ID supports up to 16 circuits).

Select Unit ID

Use this section to select the unit ID.

If the [controller type](#) is set to "Standard Controller", or if the [DMX channel mode](#) is set to "Extended Circuit IDs", both dropdown lists are enabled, with 0 through F available as the choices in each. So, for example, to use unit ID C7, select "C" from the first dropdown list, and "7" from the second.

If the DMX channel mode is set to "Virtual Controllers", only the first dropdown list is enabled. The DMX interface will use all sixteen unit IDs starting with the value selected there. For example, to use unit IDs 30 through 3F, select "3" in the first dropdown box.

Select Channel Group

A Light-O-Rama DMX interface can support up to 256 DMX channels simultaneously. However, the [intensity sliders](#) at the top of the [Test Console](#) only show sixteen of them at once (plus the master slider). To select which sixteen are currently displayed, use the "Select Channel Group" slider with the [controller type](#) set to iDMX-1000.

Set Intensities

The top portion of the [Test Console](#) shows sixteen sliders for the intensities of sixteen channels, plus a master slider (on the left) which can be used to slide them all simultaneously.

Above each slider are the Light-O-Rama [unit ID](#) and [circuit ID](#) associated with that slider. Also, if the controller type is set to iDMX-1000, then above *those* is the corresponding DMX address. These values depend upon the selections made for the [controller type](#), [DMX channel mode](#), [unit ID](#), and [channel group](#).

A common use of this is to determine the Light-O-Rama intensities to be used to produce various effects on a DMX controller. For example, a DMX controller may be able to turn on red, green, or blue lights; each of these is done by sending the same circuit a different command value. In Light-O-Rama, these are represented as intensities. The Light-O-Rama intensities and the corresponding DMX values are displayed below each slider.

So, for example, you could use this portion of the Test Console to determine that your controller turns on a blue light when sent a value of 94, which corresponds to a Light-O-Rama intensity of 37%. So, when building a [sequence](#) in the [Sequence Editor](#), you can tell this DMX controller to turn on a blue light by applying a [Set Intensity effect](#) for 37%.

Test Buttons

You can use the various buttons at the bottom of the Test Console to send lighting effect commands to the controller.

5.11 ServoDog Utility

The Light-O-Rama ServoDog Utility can be used to configure the Light-O-Rama ServoDog, which is a fourteen channel digital controller that can perform digital input, digital output, servo control and PWM ("Pulse Width Modulation") dimming.

For details on how to use the ServoDog Utility, please refer to your ServoDog manual. This can be downloaded from [the Light-O-Rama Support page](#).

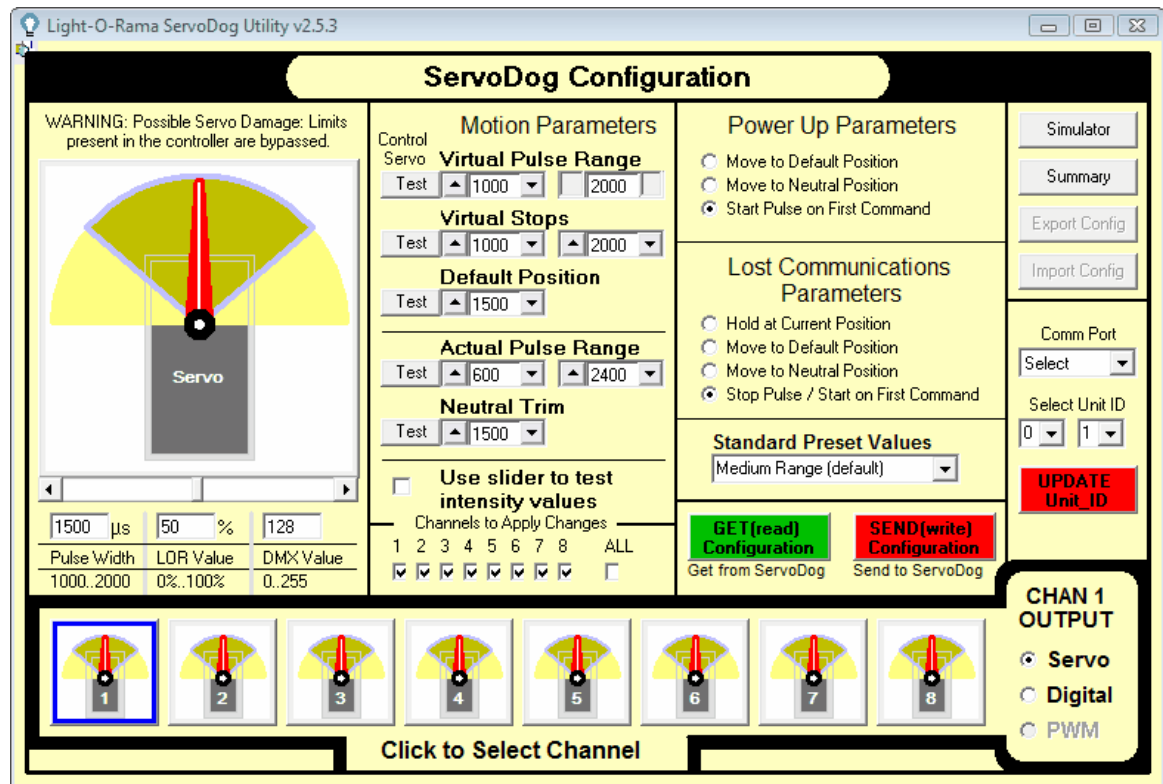

The Light-O-Rama ServoDog Utility

5.12 Visualizer

The Light-O-Rama Visualizer is a sophisticated planning and virtual hardware simulation tool designed to compliment the [Light-O-Rama software suite](#).

The Visualizer will most commonly be used during the design of your [show](#). It allows you to add and edit lights on a virtual [stage](#), to see, what they will look like in the real world. Once the design is complete and the [channels](#) are virtually wired, the [Sequence Editor](#) or the [Show Player](#) can control the Visualizer just as if it were any of the [hardware types](#) supported by Light-O-Rama. This even includes advanced controllers such as Cosmic Color Devices, as the Visualizer includes supports for all CCR macros and color modes (channels 151-157).

Since the Visualizer uses standard IP communication, it is not limited to just design simulations on your sequencing computer; it can also be used as a display item in your show. For example, you could attach a large screen TV to a computer somewhere else on your physical stage and control it from your show computer.

- [System Requirements](#)
- [Limits](#)
- [Concepts and Terminology](#)
- [Tutorial](#)
- [Advanced Topics](#)
- [Dialog Windows](#)
- [Mouse Wheel](#)
- [Shortcut Keys](#)

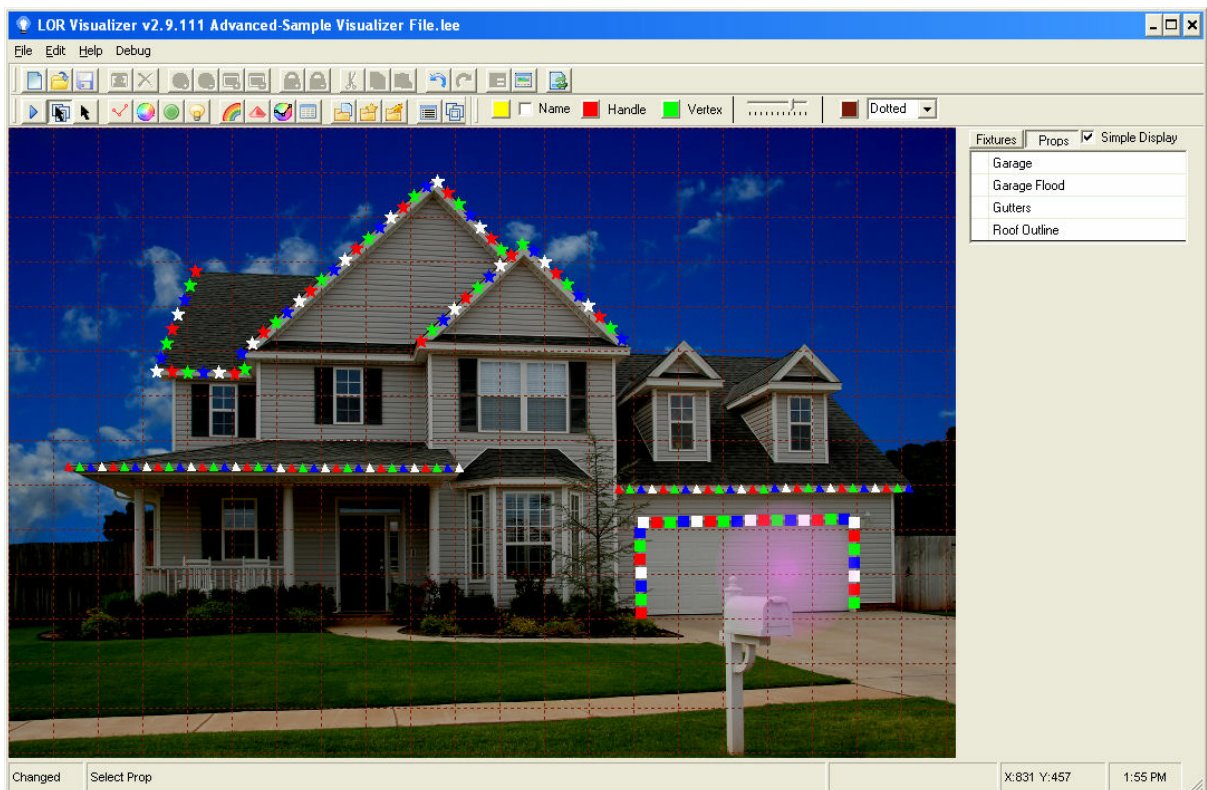

The Light-O-Rama Visualizer

5.12.1 System Requirements

For editing, the [Visualizer](#) should run without difficulty on any reasonably modern computer from the past ten years.

For simulation, the performance of the Visualizer is dependent upon the size of the simulation, the number of channels in use, and the amount of data being sent from the [Sequence Editor](#) or [Show Player](#). The Visualizer has been successfully tested with a 600x400 2000 [channel](#) RGB [sequence](#) on a 2.33 GHz Pentium 4 with 512 MB of RAM running Windows XP - a machine that is approximately 9 years old at the time of writing.

The size limit of a simulation or [background](#) is 2500x2500. If you load a simulation larger than that, or start a new simulation with a picture larger than that, you will be prompted to change the size. Please understand that just because the maximum is 2500x2500, that does not mean that you will have success with your simulation at that size. Smaller simulations will run much faster than larger ones.

5.12.2 Limits

The [Light-O-Rama Visualizer](#) imposes the following limits on your visualizations:

Editor

- **Maximum size of a simulation:** 2500x2500 pixels. However, it may be further limited based on your computer's specifications.
- **Total number of fixtures:** 1024

- **Total number of props:** 512
- **Total number of bulbs/vertices per fixture:** 256
- **Maximum number of loaded channel references:** 10,000 normal plus 10,000 RGB

Simulation

- **Maximum number of virtual channels:** Unlimited, but only the first 255 will be simulated.
- **Maximum number of fixtures per channel:** Unlimited, but only the first 16 fixtures will be simulated.
- **Device types and unit IDs:** This depends upon your license's feature level. Please refer to the [feature comparison chart](#) to check whether your device type or unit ID is supported by your feature level. **Note:** The demo version of the Visualizer counts as Basic with respect to this.

5.12.3 Concepts and Terminology

There are several concepts you should be familiar with before you create your first visualization with the [Light-O-Rama Visualizer](#):

Stage and Background

The main editor area is known as the "stage". The stage is the area where you will be designing your layout, and where the [Visualizer](#) will simulate your design. When creating your stage, you should create one large enough to comfortably create all your design elements, while minimizing the size to enhance performance. You can also import a background picture (in GIF or JPEG format) to give a more realistic representation of your stage.

Drawing Lights

Upon the [stage](#), you can draw bulbs or strings of bulbs, which are simply called "lights". The [Visualizer](#) supports multiple different light types including mini/rope lights, individual bulbs, Cosmic Color Devices, and flood lights. Strings of lights do not need to be continuous - you are free to draw a single string in one location, then another in another location, and make them both part of the same [fixture](#).

There are several different kinds of lights, shapes, and channel effects. Some fixtures can only use certain types of bulbs, or have certain parameters. For example:

- The maximum size of a flood light is 64, versus 16 for "normal" type bulbs.
- Flood lights can only be of round shape, while strings can use any of several different shapes.
- Strings are the only type of light that have a "spacing".

Fixtures

All [lights](#) automatically become part of a "fixture". The fixture is actually the primary element on your [stage](#). Whenever you create or select lights, or make changes, you are actually manipulating one or more fixtures.

Every fixture has its own set of properties depending on what kind of fixture it is and what kind of [channels](#) the fixture uses. These properties allow you to change the size of the bulbs on the virtual

stage, the [foreground/background level](#), name, comment, et cetera.

It helps to think of a fixture as a collection of zero, one, or more channels. For example, if you are using Light-O-Rama to drive a holiday light display, a single fixture could be the "Left Garage Bush", where you have four different color light strings, each being a different channel. You could then also have the "Right Garage Bush", which is a collection of four different channels.

Channels

You can use and reuse any channel on any [fixture](#). There are no restrictions on duplicating one or more channels from one fixture to another.

The number of channels you can assign to a fixture depends on the fixture type as well as the type of channels (normal or RGB). While a fixture that has no assigned channels cannot be simulated, it is perfectly acceptable to create them.

There are three different types of channels in the [Visualizer](#): CCR, Normal, and RGB. The CCR type channel can only be used with CCR (Cosmic Color Ribbon) type fixtures, and cannot be directly created. The RGB type channel, which can be assigned to any fixture type, requires exactly three Normal channels - one each for the red, green, and blue components. When these channels are rendered the three components are combined to create a bulb in true color. Normal channels consist of a single bulb color.

Since the fixture is a collection of channels, it is also where you will create those channels and the colors they represent. While you can use your [sequences](#) or [channel configuration files](#) to help create the channels within the Visualizer (see [Reference Channels](#)), you need to understand that there is no real connection between the sequence file and the Visualizer file. The Visualizer will only ever use the color you specify *within* the Visualizer for a particular channel on a fixture. For example, if you create a channel in the [Sequence Editor](#) that you specify as blue, and then create a fixture that contains the same channel in the Visualizer but instead say that it is red, it will display within the Visualizer as red, not blue.

Even if you use a reference file (i.e. a sequence file or channel configuration file), no connection is maintained between that file and the Visualizer. For example, if you use a reference file that defines a channel in the Sequence Editor as green, and then later change it within the Sequence Editor to white, the Visualizer will still render the channel in green, until you change the channel on the fixture in question within the Visualizer.

With the exception of the color, to properly communicate between the Sequence Editor and Visualizer, you must define the channel identically in both. Think of this as properly "wiring" the Visualizer, much the same as you would wire your stage. For example, if your "Left Garage Bush Blue" channel is defined in the Sequence Editor as [device type LOR](#), Regular [network](#), [unit](#) 1A, [circuit](#) 5, then you should define the channel the same way in the Visualizer: device type LOR, Regular network, unit 1A, circuit 5.

Props

A "prop" in the [Visualizer](#) is a collection of [fixtures](#). Since fixtures are collections of [channels](#), think of a prop as being an easy way to associate different collections of channels. For example, you may create a large Christmas tree on your [stage](#) that consists of eight regions, each of which is four colors. Each region could be made as a fixture, and the collection of all eight regions (fixtures) could be made a prop called "The Tree".

You do not directly draw props. Instead, you create the individual fixtures and then associate them together as a prop.

A Quick Review So Far

[Props](#) contain [fixtures](#), fixtures contain [channels](#), and channels tie the [Visualizer](#) together with your [sequence](#) that is run in the [Sequence Editor](#) or [Show Player](#).

Layers

The [Visualizer](#) uses a concept called "[layering](#)" (or "Z-Order") when creating [fixtures](#). Fixtures can be placed on one of sixteen levels from the "background" (level 1) to the "foreground" (level 16). The primary use of levels is to allow you to layer fixtures on your [stage](#). When you simulate your show, fixtures are rendered in background to foreground order. This means that fixtures on higher levels are rendered on top of those in the back. You can also disable the simulation of certain layers so that you can better see areas that may be hidden.

Layers can also help you design your stage. Much like turning off layers for simulation, you can turn them off for editing. Fixtures that are on edit disabled layers can be made invisible and cannot be selected in the main stage area. This allows for easier selection of fixtures and [props](#) that may be hidden or obstructed.

Wizards

To aid in the creation of complex [props](#) and [fixtures](#), the [Visualizer](#) provides several different [wizards](#). These wizards allow you to quickly create [Trees](#), [Arches and Fans](#), [CCRs](#), and [CCR Matrices](#). Each wizard has unique parameters.

Import/Export

The [Visualizer](#) also helps you quickly create a [stage](#) by allowing for the [import and export](#) of previously created [fixtures](#) and [props](#). You can quickly create a library of standard objects and quickly share them between different Visualizer files, or with other users.

Symbol Fixture Creation

To create complex [fixtures](#), you may want to use the "symbol" create tool. The symbol tool can take a character from a graphics font (such as "Wingdings"), and create a light string representation of it.

5.12.4 Tutorial

This tutorial will walk you step by step through creating your first visualization with the [Light-O-Rama Visualizer](#), and then controlling that simulation through the [Sequence Editor](#). The Visualizer uses standard menu items and controls, so you may want to skip this section and dive right in if you are comfortable.

Since the majority of users of Light-O-Rama create light [shows](#) for the outdoors, this tutorial is geared towards them. However, the concepts presented here apply equally to any [stage](#).

To begin using the Visualizer, you should first have a digital picture of your stage in either JPEG or GIF format (JPEG is recommended). You may want to edit your picture in a photo editing program to reduce its size and to cut out parts of your stage that will not be used in your show. If you would like to follow

along exactly with this tutorial, use the one supplied with the Visualizer (called "InTownHouse.jpg", located in the "Visualizations\Editor\LOR Visualizer Tutorial" directory).

A Quick Review of the Main Window

Start the [Visualizer](#) just like you would any other program in the [Light-O-Rama software suite](#) (either through the [LOR Control Panel's popup menu](#), or your computer's Start menu). There are several main areas of the Visualizer that you should be familiar with:

- Near the top of the screen, you'll see the tool bars. The tool bars give you a quick way to perform most of the commands within the Visualizer. The three toolbars are:
 - **The Edit Bar:** Commands on this bar allow you to manipulate the simulation, [fixtures](#), [props](#), or the [background](#). It includes things such as new file, cut/copy/paste, et cetera.
 - **The Draw Bar:** Commands on this bar allow you to change to various modes - prop selection, fixture selection, simulation, et cetera.
 - **The Display Bar:** Allows control of information display, including the colors of prop and fixture names, the drawing grid, et cetera.
- On the right side, when a simulation is loaded, you'll find the list of props and fixtures being used in the current file. The list is called the "Object Selection" area.
- At the bottom of the screen is the status bar. Program information is displayed there, including the current cursor location, if the file is unsaved, et cetera.

Create a New File

Select the "New File command" to begin creating a new [Visualizer](#) file. You can create the new file by going to the "File" menu and selecting "New", or by selecting the "New File" command on the Edit toolbar. Most menu commands are duplicated on the toolbars.

You will be presented with the first of two dialog windows. The first window asks you if you would like to use a background picture for your [stage](#), or if you would like to use a "blank" background. For this tutorial, select the "use a background" picture option, and then press the select file button ("..."). You can select either a picture of your own stage, or the sample file ("InTownHouse.jpg") included when you installed the Visualizer.

The next dialog presented will allow you to change the size of the simulation. When creating a new simulation, you need to take into account the performance of your computer. The larger the simulation you create, the more resources the Visualizer will need when running your simulation. If you are using the included sample background, you can keep the size as-is. Otherwise, a good size to start with is 800 x 600. The system will automatically resize your background picture to fit the window size you specify. You could also divide your stage up into several different Visualizer files for ease of use. For instance, you may want to use one for stage left, and a separate one for stage right. You should also remember that Visualizer files are separate from any [sequence](#), [channel configuration](#), or [show](#) file. You can use and Visualizer file with any show or sequence.

If you like, you can change the intensity of the background using the slider here, or the one on the "Display Tool Bar" found on the main screen.

Once you have selected your size, the main edit screen will be updated with your new parameters and picture. If in the future you wish to change the size of the simulation or the background graphic, you

may do so by selecting "Simulation Properties". If you resize your simulation, the Visualizer will automatically reposition all of your [lights](#). If you change the background graphic, you will need to move things around as needed.

Drawing Lights and Creating Fixtures

We will now create some [lights](#) and [fixtures](#). Select the "Light String" icon on the toolbar or from the menu: Edit / Toolbox / Draw Light Strings. Move the mouse to the main editing area and your cursor will change into a pencil. You are now in "draw" mode. There are several different draw modes, depending on which tool you are using. Currently you are drawing "strings"; other tools allow you to draw "flood lights", "single bulbs", "CCRs", et cetera.

Pick a place where you would like to start drawing strings, and click the left mouse button once. For this tutorial, select the leftmost roof edge. Now move the mouse to the second location - at the bottom of the roof. When you move the mouse, you'll see a sight line appear. It is along this line that the [Visualizer](#) will create your string of lights. Click again. This anchors the lights at that location, and you can continue drawing. Draw several more lines of lights along the roof until you get to the second "peak", and then double click. You've just created your first fixture!

Depending on if you have changed any of the Visualizer options, you should be presented with the "Fixture Properties" dialog. If it didn't automatically show, simply double-click "New Fixture 1" in the object selection area on the right of the main screen. The Fixture Properties dialog allows you to change many different aspects of a fixture. For a complete description of all the different options, please see the section titled "Fixture Properties".

The first thing to do is to give your new fixture a descriptive name. Since we outlined the roof, simply call it "Roof Outline". You are free to name fixtures any way you like. The comment field is a convenient place to hold information you may want to use later - actual lengths of lights, amperage drawn, et cetera.

Skip down to the "Assigned Channels" section, so we can set some [channel](#) colors. Click on the first row, and the "Channel Settings" dialog will appear. This dialog is similar to the one you use in the Sequence Editor to define a channel. We'll touch more on this dialog later when we get ready to do a simulation, but for now we simply need to give the channel a name and a color. Call the first channel "Roof Red", and then set the color to red. Hit "OK", and then create three more channels, in green, blue, and white.

While you were creating those channels, the changes were being reflected in the "Sample Bulbs" area. Light strings in the Visualizer are a lot like multi-wire rope lights: Along the path you drew, the Visualizer will create as many repeating groups of lights as needed. First, hit the "Background Color" button, and change the color to black if it is not already. You should now be able to see all four bulbs in the colors you specified. The background color button only affects the display of the sample bulbs in this dialog; it has no other effect.

Since we are playing with the bulbs, let's check out a couple more things you can do with them. The "Size", "Spacing" and "Shape" are exactly what they sound like: Size controls how big each bulb is on the string. Spacing controls how much empty space is left between bulbs. Shape lets you choose from ten different types of bulbs - round, various stars, and so forth. For our example, choose the "5 Point Star" with size 6 and spacing 2. Now press OK and your main screen will be updated with the new bulbs following the path you created.

Now let's create another string. Start at the left of the second peak and draw up to the top, then back down to the right, ending with a double click. A new dialog appears that allows you to assign this new

drawing to an existing fixture, or to use it as the basis for a new one (if you were not prompted, delete this new drawing, go to "File / Options / 4. Fixtures" and change the "Assume the fixture is new" dropdown from "Always" to "Ask", and then try again).

Since this is another roof string, select the "Roof Outline" fixture. By repeating these steps, you can create lights on different parts of your stage that all behave using the same channels. Your roof now consists of two separate strings.

Take what you have learned up to this point, and create two more string fixtures: one for the gutters, and another around the garage door. Be sure that each fixture has four channels assigned, and that the channels are red, green, blue and white (in that order). Make them any shape you want, along with any size or spacing you desire.

Different Kinds of Fixtures

The [Visualizer](#) does not limit you to only the string [fixture](#). In fact, there are four different types of fixtures you can create:

- **String:** Multi-wire rope light
- **CCR:** Cosmic Color Ribbons and other Cosmic Color Multi-Bulb fixtures (such as CCBs)
- **Flood:** Flood lights
- **Single Bulbs:** Single-point light sources - Christmas tree stars, strobes, et cetera

The Visualizer is RGB-Aware

Let's create a new Cosmic Color Flood Light that shines on the garage door. The [Visualizer](#) is RGB-aware, and can properly blend [channels](#) into more than sixteen million colors.

Select the Flood Light tool, and then click on the center of the garage door. The "Fixture Properties" dialog box will appear, but you may notice that it looks a little different. Name the flood light "Garage Flood", and change the size to 64.

Change the "Channel Type" from "Normal" to "RGB". Three channel spaces will now open up. Name each channel, just like you did with the String fixtures. Notice that you can't change the colors - that is because this is an RGB fixture, and the Visualizer will blend the values that it receives from the Sequence Editor or Show Player to create the actual color of the bulb.

You may have noticed that when you selected channel type RGB, the "RGB Sample Color" button was enabled. This sample color is only used to draw the bulb while you are editing. To help keep things separate, make the sample color something that you don't normally use on your [stage](#). For now, we can keep the pink color. Press "OK".

Editing Strings and Bulbs

Let's also take a moment to learn about editing strings and lights. Click on the "Fixture Select" tool on the toolbar (or Edit / Toolbox / Fixture Select Tool from the menu). The cursor changes to an arrow. Now click on one of the strings over the roof.

The light string will turn into a dashed line, and a lot of "handles" will appear in red and green (or, if you changed them, the colors you selected). The red handles are called "tool handles". They allow you to stretch, shrink, skew, and rotate the entire [fixture](#). For example, you can grab a corner and drag; doing so will make the fixture bigger or smaller. The tool handles are as follows:

- Four corners: Stretch and shrink
- Four middle arrows: Skew
- Dot (right side): Rotate
- X (middle): Move

The green handles are called "vertex handles". You can grab any one of these and move that light anchor to a new location, or delete it. Place the cursor over one of the vertex handles, and it changes to a cross-hair. Click once, and this point is removed. Click and drag, and this point is moved to a new location.

You can split a string into two separate segments by simply placing the cursor over the sight line between any two points and clicking once. A new vertex handle will be created.

Once you are done experimenting, put the Roof Outline fixture back where it belongs.

Object Selection Area

The object selection area on the right can also be used to select a [fixture](#). Click any fixture name, and it will be selected just as if you pointed at that fixture and clicked at it in the editor. This is useful if you have multiple fixtures that are close together, and can't seem to be able to select the one you want. If you want to change the properties of a fixture, double clicking the fixture name in the list will bring up its properties box.

The Visualizer has many commands that you may already be familiar with from other editing software: Delete, Cut, Copy, Paste, et cetera. Feel free to learn about them at your own pace.

Wiring

Now that you have created a few [fixtures](#), let's wire those fixtures up so you can run your first simulation.

For now, we are going to create the [channels](#) manually, but you could also load a [Sequence Editor](#) file into the [Visualizer](#) and use it as a "reference" - something you can learn more about in the Reference Files section of this help file. Once you have wired a fixture, the Visualizer will remember the settings each time you load this simulation file.

Double click the "Roof Outline" fixture in the object selection area on the right. The now-familiar Fixture Properties dialog will be shown. Click on the first channel (the red one that you created), and you will be presented with the Channel Settings box.

In order for your simulation to be properly controlled by the Sequence Editor or any other program in [the suite](#), the channel details must match those in the [sequence](#). Since you are probably the most familiar with [Light-O-Rama controllers](#), let's use those:

Set the Red channel to device type "Light-O-Rama Controller". When you do that, more fields become available. Set the [network](#) to "Regular", the [unit](#) to "01", and the [circuit](#) to "1". Leave the "Special Type" field blank. Then press "OK".

You have now "wired" the first channel of this fixture. Go ahead and wire up the next three channels, using circuits 2 through 4 (green as 2, blue as 3, and white as 4). Now wire up the Gutters fixture using circuits 5 through 8, and the Garage Door fixture using circuits 9 through 12 in the same manner.

RGB fixtures are wired similarly, so go ahead and wire up the Flood Light fixture using circuits 13

through 15. You should save your file now by using the "Save" icon in the toolbar, or by selecting "File / Save" from the menu.

The most important thing to remember about wiring up your simulation is that there is no connection between what a channel is called or what its color is in the Sequence Editor and what the name or color is in the Visualizer. Just as with a physical controller, you could call a channel "Blue Door" in the Sequence Editor, but hook it up to the "Red Tree" on your stage. If you see unexpected results during a simulation, this is the first thing to check.

Running Your First Simulation

Now we need to do a bit of setup so that the [Sequence Editor](#) and the [Visualizer](#) can "talk" together. You should only need to do this once, and possibly in the future if you do something such as changing computers. The defaults should work, but we should double check them.

Select File / Options from the menu, and then click on the "6. Com/Ref" settings tab. Check that the Communications field is set to "Local", that the IP address reads "127.0.0.1", and that the port is "30303". Press "OK".

Start the Sequence Editor, and load the tutorial test sequence that was included (located in the directory "Sequences\LOR Visualizer Tutorial"). Go to [Edit / Preferences / Visualizer Preferences](#). Ensure that the Host is set to 127 0 0 1, and the port to 30303. The thing to take away from this is that the Visualizer settings and the Sequence Editor settings must match with each other; if the two programs are set up differently, change one or the other so that they match, and then press OK.

Ensure that the Sequence Editor is set up to control the Visualizer: From its [Play menu](#), ensure that the "[Control Visualizer](#)" option is checked. If it is not checked, the Sequence Editor will not send any commands to the Visualizer.

Almost there. Unless the Visualizer is placed into Simulation mode, it will ignore all commands from the Sequence Editor. To place the Visualizer into Simulation mode, press the "Play" icon in its toolbar. The Visualizer will then go into Simulation mode, hiding many of its controls and toolbars. It is now ready to accept commands from the Sequence Editor.

Note: Depending upon your operating system and security settings, you may be prompted that the Visualizer was blocked from communicating. If so, you can select "Unblock". If you do not unblock the Visualizer, it will not be able to receive commands from the Sequence Editor. For more information, see the section titled "[Simulation and Firewalls](#)".

Now play your sequence in the Sequence Editor (using its [Play button](#) on its [standard toolbar](#)). If everything is set up correctly, you'll see the lights in your simulation flash on and off. Congratulations!

If you don't see any lights flashing, make sure that you have correctly set up the communications parameters, that you have selected "Control Visualizer" on the Sequence Editor's Play menu, that the Visualizer and the Sequence Editor are both in "play" mode, and that you have wired up your channels correctly. If you see wrong lights flashing, make sure that you have wired your channels properly.

5.12.5 Advanced Topics

This section covers several advanced topics for the Light-O-Rama Visualizer:

- [Wizards](#)
 - [Tree Wizard](#)
 - [Arch/Fan Wizard](#)
 - [CCR Wizard](#)
 - [CCR Matrix Wizard](#)
 - [Channel Assignment Wizard](#)
- [Reference Channels](#)
- [Virtual Channels](#)
- [Importing and Exporting Fixtures and Props](#)
- [Symbols](#)
- [Locks](#)
- [Levels](#)
- [Colors and Background Intensity](#)
- [Using Cosmic Color Devices in the Visualizer](#)
- [Multi-Color Channels \(Strings\)](#)
- [Simulation and Firewalls](#)

5.12.5.1 Wizards

There are several different types of wizards available in the [Light-O-Rama Visualizer](#). Some help you draw complex props, while others help you to quickly assign [channels](#) to the [fixtures](#) associated with a [prop](#) (the [Channel Assignment Wizard](#) and the [Fixture Rename Wizard](#)).

All drawing wizards create a prop and one or more fixtures. Depending on the options you select, you will be presented with one or more dialog boxes that allow you to specify how the required fixtures will be created. In general, you can elect to create new fixtures, or assign the wizard data to existing fixtures, or a combination of both.

Note that after you use one of the drawing wizards, what is created is just like any hand-drawn fixture. If you want to modify your newly created prop, it may be easier to delete it and start again with the appropriate wizard rather than trying to move individual bulbs, pixels, et cetera.

- [Tree Wizard](#)
- [Arch/Fan Wizard](#)
- [CCR Wizard](#)
- [CCR Matrix Wizard](#)
- [Channel Assignment Wizard](#)

5.12.5.1.1 Tree Wizard

The [Light-O-Rama Visualizer's](#) Tree Wizard helps you create "light trees": strings of lights or CCR pixels that are shaped like Christmas trees. To run the Tree Wizard, select it from the draw toolbar and click where you would like the base of the tree in the editor. The Visualizer will then present the Tree Wizard dialog.

There are many options that let you customize the way the tree will be built, and the choices you make will be shown to you in the example drawing. The scroll bars can be used to change the orientation of the tree.

5.12.5.1.2 Arch/Fan Wizard

The [Light-O-Rama Visualizer's](#) Arch/Fan Wizard (also referred to as simply the "Arch Wizard") can create arches of fans of light. Like the [Tree Wizard](#), you can select the Arch Wizard from the Visualizer's toolbar and then click where the base of the arch should be located. The Visualizer then presents the Arch Wizard dialog.

The options here let you set your preferences, and the scroll bar can be used to rotate the edge from "straight on" to "edge on".

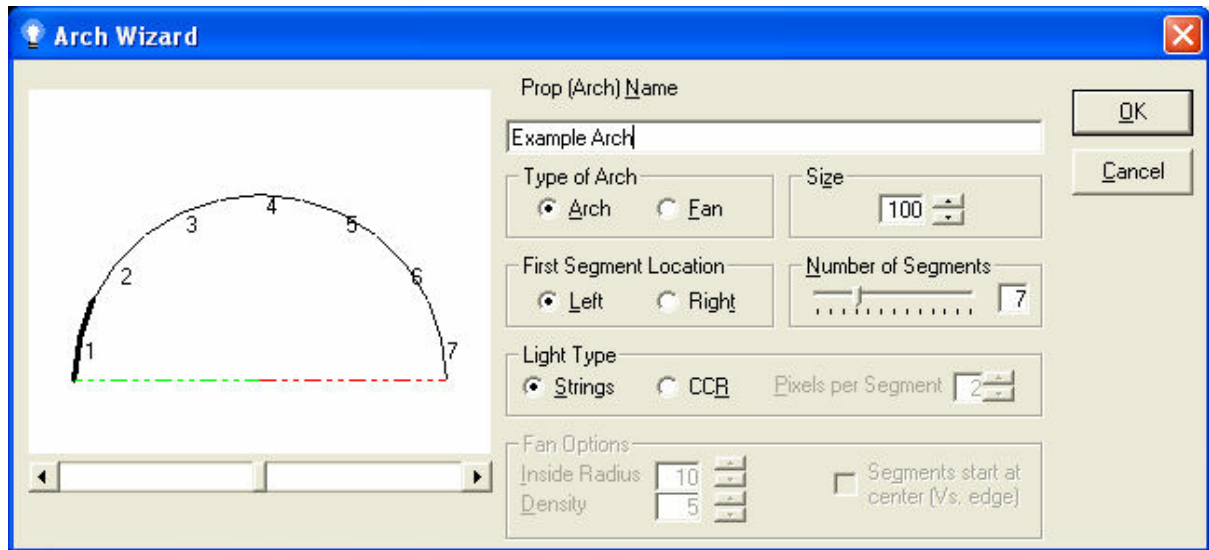

The Visualizer's Arch/Fan Wizard

5.12.5.1.3 CCR Wizard

The [Light-O-Rama Visualizer's](#) CCR Wizard (not to be confused with its [CCR Matrix Wizard](#)) allows for the quick placement of Cosmic Color Ribbon (or other Cosmic Color Device) pixels along a path specified by the user.

The CCR Wizard can be thought of as a hybrid between the String Drawing tool and a wizard. When you select the CCR Wizard, your cursor will change to a pencil. You can now draw a path, much like using the Light Strings tool. When you double click, the Visualizer will ask you how many pixels the path represents (up to 500), and then it will space CCD pixels equidistantly along the path.

5.12.5.1.4 CCR Matrix Wizard

The [Light-O-Rama Visualizer's](#) CCR Matrix Wizard (not to be confused with its [CCR Wizard](#)) allows you to create a jumbotron-style display of CCR pixels. Once you select the tool, you will need to draw a rectangular area in your editor. Once you have marked the start and end corners, the CCR Matrix Wizard dialog is presented, wherein you can specify the options required.

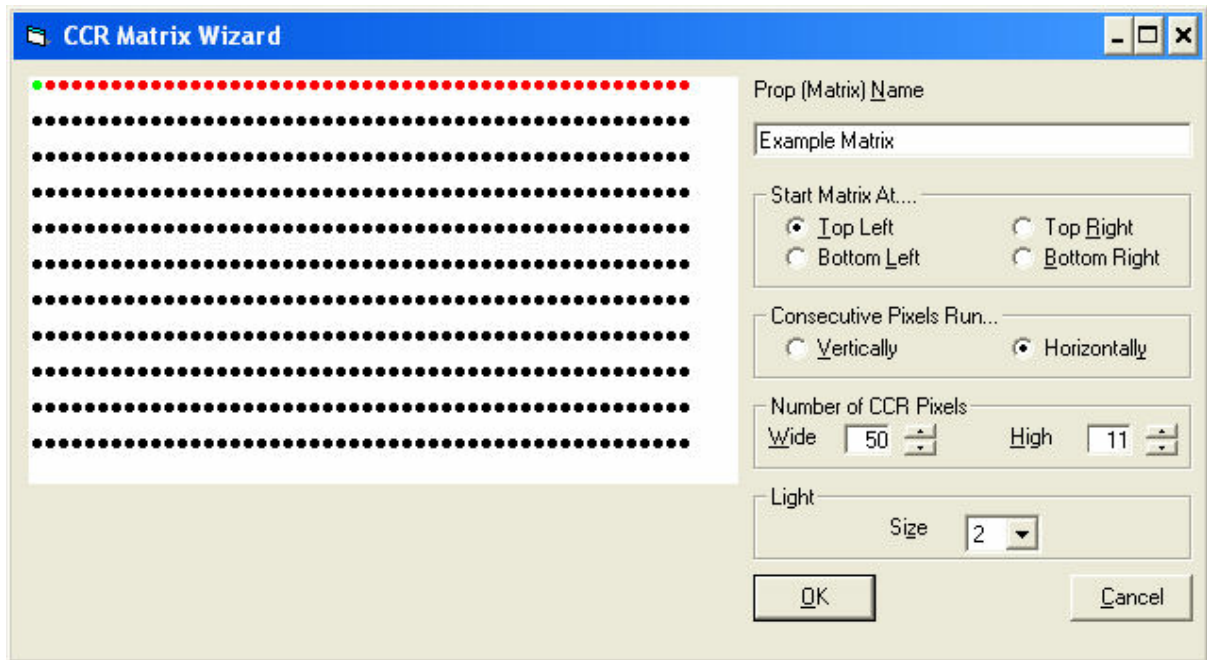

The Visualizer's CCR Matrix Wizard

5.12.5.1.5 Channel Assignment Wizard

The [Light-O-Rama Visualizer's Channel Assignment Wizard](#) helps to quickly assign [channels](#) to complex [props](#). It is accessed from the [third tab](#) on the [Prop Properties box](#).

The Channel Assignment Wizard is only available for props that have one or more assigned [fixtures](#), and then only when all of the prop's fixtures are of the same type. If you have assigned two or more different fixtures (for example, a String fixture and a Flood Light fixture) to the same prop, the Channel Assignment Wizard cannot be used for that prop.

The Channel Assignment Wizard can quickly create new channels, or assign channels that you have previously loaded via a reference file. Props that contain CCRs use a different channel wizard (the CCR Channel Assignment Wizard) that is documented separately.

There are multiple steps required to finish this wizard, and not all steps are necessary for different channel/fixture combinations.

- [Assigning New Channels to Non-CCR Fixtures](#)
- [Assigning Reference Channels to Non-CCR Fixtures](#)
- [Assigning Channels to CCR Fixtures](#)

Assigning New Channels to Non-CCR Fixtures

Step 1: Identify if the [channels](#) will be Normal or RGB.

Step 2: Identify if the channels will be new or use a previously loaded [Sequence Editor](#) reference file (new, in this case).

Step 3: Identify the total number of channels to be assigned per [fixture](#), and what the colors of those channels will be.

Step 4: Identify the type of [device](#) to be used ([Light-O-Rama](#), [Dasher](#), etc.), and, if LOR, the addressing mode (normal or legacy).

Step 5: Identify if the system should automatically go on to the next [unit](#) in sequence, or if the user wants to be prompted when the wizard exhausts all available circuits on a unit.

Step 6: Identify the channel data to be used: [network](#), unit and [circuit](#). Not all device types use all of these fields.

Assigning Reference Channels to CCR Fixtures

Step 1; Identify if the [channels](#) will be Normal or RGB.

Step 2: Identify if the channels will be new or use a previously loaded [Sequence Editor](#) reference file (use a previously loaded Sequence Editor reference file, in this case).

Step 3: Identify the total number of channels to be assigned per [fixture](#), and if the user wants to automatically go on to the next [unit](#) in sequence, or if he or she wants to be prompted when the wizard exhausts all available [circuits](#) on a unit.

Step 4: Identify the first reference channel to be used. Reference channels are then used in order from this point.

Assigning Channels to CCR Fixtures

For each CCR [fixture](#) that is part of a [prop](#), the [Visualizer](#) will present a dialog allowing the user to set the base address and other CCR parameters.

5.12.5.2 Reference Channels

You can use any [sequence](#) file or [channel configuration file](#) to help you assign [channels](#) to [fixtures](#) in the [Light-O-Rama Visualizer](#). The Channel Assignment Wizard can also help with assigning reference channels to complex [props](#).

Note: It must be remembered that there is no connection between the Visualizer and the reference file used to assign channels to a visualization. Once you assign a channel in the Visualizer, changes to that channel in the Sequence Editor are not automatically reflected in the Visualizer, nor vice versa.

To load a reference file, select the "Load LOR Channel References" command. From here, you can load one or more sequence files ([musical](#) or [animation](#)), or channel configuration files. Press the select file button ("...") to pick the file that you want to use, and then press the LOAD button.

Once a file is loaded, the Visualizer will sort the channels and then attempt to remove all duplicates. If the program cannot determine which channel should be used, a dialog will be presented to you to choose which channel you wish to keep.

When you select the DONE command, you are given the option to update your fixtures with the new channel data. The Visualizer will then attempt to match your imported channels with those already defined in the Visualizer, and update where applicable.

Loading a channel reference file will also make it easier to initially assign channels to your fixtures. Once you have loaded one or more channel references, a button becomes available on the Channel Settings window, allowing you to select a channel from those loaded. Once selected, the program will fill in all the rest of the window (name, color, device type, etc.).

5.12.5.3 Virtual Channels

Depending on the [device type](#) you specify for a [channel](#), the [Light-O-Rama Visualizer](#) listens for commands based on a "key". For example, if a channel of a [fixture](#) specifies that it is [LOR hardware](#), then the [network](#), [unit](#), and [circuit](#) are all required. When the Visualizer receives a command from the [Sequence Editor](#) or the [Show Player](#), it will match that command with that channel if the device type, network, unit, and circuit all match. In this case, it helps to think of the Visualizer as a physical light controller: When you physically wire your devices to your controllers, those controllers do not care what color lights you hooked up, nor what you named the channel in the Sequence Editor.

However, the Visualizer has another type of channel, called the virtual channel. If you don't specify a device type, then the Sequence Editor will send, and the Visualizer will attempt to match, the channel's name. For example, this could be used to create a "beat channel", flashing with the beat of a song, that isn't actually hooked up to any real string of lights on any controller, but which can be viewed in the Visualizer.

You can utilize this functionality by creating the channel in the Sequence Editor as having no device type, and in the Visualizer wire the channel using an identical name and no device type.

Notes:

- The Visualizer will not simulate virtual channels from a [compressed sequence](#).
- There is a limit of 255 virtual channels in the Visualizer. If your simulation has more than 255 virtual channels, then only the first 255 will be simulated.

5.12.5.4 Importing and Exporting Fixtures and Props

The [Light-O-Rama Visualizer](#) makes it easy for you to create a library of frequently used [fixtures](#) and [props](#), and to share those fixtures and props with other Visualizer users if you desire.

To export a fixture, first select it and then open the fixture's properties dialog. Click on "Export Fixture File", and give your fixture a file name. When you press OK, you will be asked if you also want to save the fixture's [channel](#) data. Saving the channel data allows you to quickly import this fixture into another simulation, without the need to wire it up. If, however, your channels will be changing, you plan on using this fixture with multiple sets of channels, or if you intend to share this fixture with other users, you may want to not save the channels during the export.

To import a fixture, select the "Insert Fixture from File" tool. Select the fixture you wish to import, and press OK. If there were one or more channels defined on the fixture, you will be asked if you want to retain them or blank them out.

Importing and exporting props works in the same way as importing and exporting fixtures, except that you start the process on the "Prop Properties" dialog box. When you import a prop, you are also given the option to rename the prop and the associated fixtures.

5.12.5.5 Symbols

The [Light-O-Rama Visualizer](#) allows you to use a character (symbol) from a font to create a [fixture](#), and several graphical fonts have been included with the application. To create a fixture from a symbol, click the [Insert Fixture from Symbols tool](#). Select one of the fonts at the top of the screen, and then select a picture you would like to use. Note that you cannot use overly complex drawings: If the "# Of Points" line just above the OK button is red, you cannot use that particular symbol.

5.12.5.6 Locks

While working in the [Light-O-Rama Visualizer](#), you may find that your [stage](#) is cluttered and that you keep accidentally changing a [fixture](#) or [prop](#) that you don't intend to change. To prevent this from happening, you can "lock" the object. There are multiple ways to lock or unlock an object:

- Select it, go to its properties, and click the "Locked" checkbox
- Select it, and press the "Lock" or "Unlock" icon in the toolbar
- Click the area to the left of the name in the object list.

When an object is locked, you cannot select it in the main editing area. The object will still be there, but it won't react. If, however, you select it in the object list on the right (by clicking on its name), the lock is ignored and you can work with the object.

Note that it is possible to lock a prop while still leaving the features associated with that prop unlocked.

There are two different kinds of lock - fixture lock or prop lock - which means there are four possible lock stats: none (blank), Fixture Locked, Prop Locked, and Both Locked.

Fixture Mode

The lock is either blank (unlocked) or blue (the fixture is locked). The system ignores the state of the prop if this fixture is assigned to one.

Prop Mode - Normal Display Mode

(This means every fixture of a prop is displayed in the list). All three colors are used:

Blue Lock: The fixture is not part of a prop (so it is considered a "virtual" prop), and the fixture itself is locked, or this is a real prop, and it is unlocked, while this particular fixture is locked.

Purple Lock: The prop is locked, but this particular fixture (which is part of the locked prop) is unlocked.

Yellow Lock: The prop is locked, and this particular fixture is locked as well.

Prop Mode - Simple Display Mode

(Only the prop name or the virtual prop name is displayed). All three colors are used:

Blue Lock: This is a virtual prop (it is actually just a fixture that is not assigned to a prop), and the fixture is locked, or this is a real prop and one or more of the fixtures assigned to the prop are locked, but the prop is not locked.

Purple Lock: This prop is locked, and none of the fixtures associated to the prop are locked (all are unlocked).

Yellow Lock: This prop is locked, and one or more of the fixtures associated to the prop are locked as well.

5.12.5.7 Levels

The [Light-O-Rama Visualizer](#) allows you to stack objects on top of one another, and then specify which are on top of the others. In the computer world, this is called "Z-Order", or "layering". Things that are in the foreground will have a higher "level" than those in the background.

There are several ways you can use levels:

- While a simulation is running, objects that are in the foreground will be rendered "on top of" those in the background. This gives a "see through" effect that more accurately represents your [stage](#).
- You can also turn off one or more levels during simulation. This could be useful if you have foreground objects that are completely obscuring things in the background, or if you are trying to increase the performance of the simulation.
- During editing, placing your [fixtures](#) on levels allows you to segregate your stage. For example, while drawing your background lighting, you could turn off all other levels, or display them at a lower intensity.

The Level Visibility and Properties box allows you to turn levels on or off for simulation, rename them, et cetera. A fixture can be moved between levels in several ways, by selecting the fixture and then:

- Using the properties box of the fixture
- Using the "Move Forward" or "Move Backward" icon
- Using the "Move to Foreground" or "Send to Background" icon

5.12.5.8 Colors and Background Intensity

The [Light-O-Rama Visualizer's](#) Display Bar has buttons to quickly change the color of fixture names, tool handles, and vertex handles. You can also quickly change the intensity of the [background](#) by using the slider, and turn on or off various grid markers to help you in drawing fixtures.

5.12.5.9 Using Cosmic Color Devices in the Visualizer

There are some special considerations when using Cosmic Color Devices in the Visualizer.

- [Cosmic Color Floods](#)
- [Cosmic Color Ribbons / Cosmic Color Bulbs](#)
- [CCR Options and Addressing](#)
 - [Full CCR/CCB Fixtures \(single master\)](#)
 - [Master/Slave CCR/CCB \(split CCR/CCB\)](#)
- [Compile Errors](#)
- [Master/Slave CCR/CCB Simulation Considerations](#)

Cosmic Color Floods

Create a Cosmic Color Flood the same as any other flood light. Specify that the fixture is RGB, and assign the correct [channels](#) to the flood.

Cosmic Color Ribbons / Comic Color Bulbs

The Visualizer considers both of these devices identical and calls them by a single name: CCR.

CCR Options and Addressing

In the real world, a CCR/CCB consists of 50 pixels or bulbs tied to a single controller. However, this may not be convenient when working in the Visualizer, so they can be handled in two different ways: [Full CCR/CCB Fixtures](#) or [Master/Slave CCR/CCB](#). In the end, both ways will simulate the same way; the only difference is how the CCR/CCB [fixtures](#) are defined.

Full CCR/CCB Fixtures (single master)

Using this method, a single CCR/CCB [fixture](#) in the Visualizer represents a single physical CCR/CCB. In this way, all 50 pixels are assigned to the same Visualizer fixture regardless of where they are placed on the [stage](#). Simply set the "Physical Starting Pixel" to 1, and set the rest of the CCR/CCB parameters as needed.

Master/Slave CCR/CCB (split CCR/CCB)

This is the recommended method. Using this method, two or more [fixtures](#) represent a single physical CCR/CCB. This allows you to group consecutive like-pixels together for easier editing. The CCR/CCB with physical pixel #1 is considered the "master". To create "slaves", specify a physical pixel number greater than 1 with the same Network and Base Unit ID as the master. You cannot specify a unit ID mode, channel mode, or resolution on slave CCRs/CCBs.

Compile Errors

When a simulation is started, all CCRs/CCBs are checked to ensure that they have exactly 50 pixels, a master, et cetera. Should an error be found, the simulation will not run, and you will be presented with a list of errors to correct. Once the errors are corrected, the simulation will run. When correcting errors, it may be easier to only correct the first error presented and then attempt to run the simulation again. That is because a single problem could cause multiple errors.

Master/Slave CCR/CCB Simulation Considerations

While editing, you can place split CCR/CCB [fixtures](#) on different [foreground/background levels](#), and the Visualizer will display them as such. You can also assign different bulb sizes, and that too will be honored.

While in simulation mode, however, all the "attached" fixtures will behave as if they are on the same level and with the same bulb size as the master fixture. That is because the system needs to compile all the separate fixtures into one main entity, and that entity takes the parameters of the main CCD.

5.12.5.10 Multi-Color Channels (Strings)

The Visualizer can support multi-color sets using a sub-channel type. Only the String type can use multi-color.

To create a multi-color channel, create a string [fixture](#) and assign a [channel](#) to it. In the "Special Type", select "Multi", and then select the total number of physical colors this channel will represent. After selecting the number, one or more color boxes will appear to allow you to set the color.

By specifying Multicolor, you can assign up to five different colors to the channel. You don't individually

control these colors. When the channel is on, then all (1-5) of those bulbs are on.

Fixtures can have multiple multi-color subtypes. In theory, you can create a fixture with 80 separate colors (16 controlled in groups of 5), but there is a lot of overhead when creating multi-color bulbs, and so that is not recommended. The multi-color sub-type can also be used to simulate multi-channel rope light where there is more than one bulb per circuit.

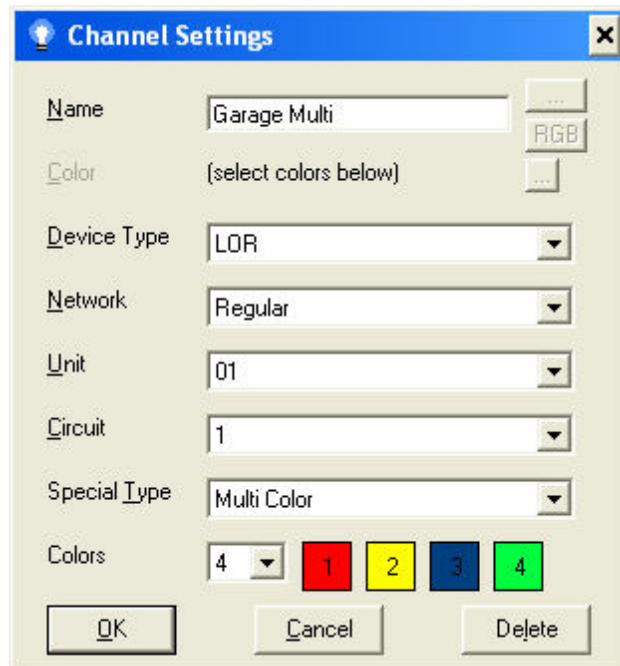

Multi-Color settings

5.12.5.11 Simulation and Firewalls

Depending upon your computer's operating system and/or the internet security programs you may be using, the [Light-O-Rama Visualizer](#) may not be able to communicate with the [Sequence Editor](#) or [Show Player](#), due to being blocked by your firewall. In this case, you may need to take steps to tell your firewall to allow the Visualizer to communicate:

Using the Built-In Windows Firewall

If you are using the Windows Firewall that is included in Windows from Windows Vista onwards, allowing the Visualizer to communicate is easy. The first time that you place the Visualizer into Simulation mode, the Windows Firewall will prompt you, stating that "Windows Firewall has blocked some features of this program". From that dialog, simply press the "Unblock" button. Depending upon the settings of your system, you may then be prompted again, with "Windows needs your permission to continue". If so, select "Continue".

If at any point you accidentally told Windows Firewall to keep blocking the Visualizer, you can change that by:

1. Pressing the Windows Start button
2. Typing "firewall" into the search box
3. Clicking on the "Windows Firewall" entry (note: *not* the "Windows Firewall with Advanced

- Security Options" entry)
4. Clicking "Allow a program through Windows Firewall" (on the left)
 5. Select "Continue" if prompted
 6. On the "Exceptions" tab, scroll through the list of programs until you find LORVisualizer
 7. Place a check mark in front of LORVisualizer, and click OK
 8. Restart the Visualizer



Windows Firewall blocking the Visualizer

Using Other Security Programs

Please check with the author or help system of your security software on how to unblock the Visualizer.

5.12.6 Dialog Windows

This section describes the various dialog windows used in the [Light-O-Rama Visualizer](#):

- [About](#)
- [Arch/Fan Wizard](#)
- [Assign Fixtures from Wizard](#)
- [Assign to Fixture](#)
- [CCR Matrix Wizard](#)
- [Change Size](#)
- [Channel Assignment Wizard](#)
- [Channel Settings Dialog](#)
- [Draw CCR Wizard](#)
- [Duplicate Channel Reference](#)
- [Duplicate RGB Channel Reference](#)
- [Fixture Properties](#)
- [Insert Symbol Fixture](#)
- [Level Visibility and Properties](#)

- [Load LOR Reference File](#)
- [Main Editing Window](#)
- [Main Editor Window](#)
- [Menu Items](#)
- [New Prop](#)
- [New Simulation](#)
- [Object Selection Area](#)
- [Options](#)
- [Prop Properties](#)
- [Rename Fixture](#)
- [Rename Prop](#)
- [Reorder Prop \(Change Fixture Order\)](#)
- [Select Reference Channel](#)
- [Simulation \(Background\) Properties](#)
- [Simulation \(Compile\) Errors](#)
- [Status Bar](#)
- [Toolbars](#)
- [Tree Wizard](#)

5.12.6.1 About

This [Light-O-Rama Visualizer](#) dialog shows your license information and Visualizer revision information.

OK

Close the dialog.

System Info

Run the Microsoft System Information program, to gather and display statistics about your computer.

5.12.6.2 Arch/Fan Wizard

This [Light-O-Rama Visualizer](#) wizard allows you to create light arches or fans with either strings or CCRs.

- [Example Picture](#)
- [Prop \(Arch\) Name](#)
- [Type of Arch](#)
- [Size](#)
- [First Segment Location](#)
- [Number of Segments](#)
- [Light Type](#)
- [Pixels per Segment](#)
- [Fan Options](#)
- [OK](#)
- [Cancel](#)

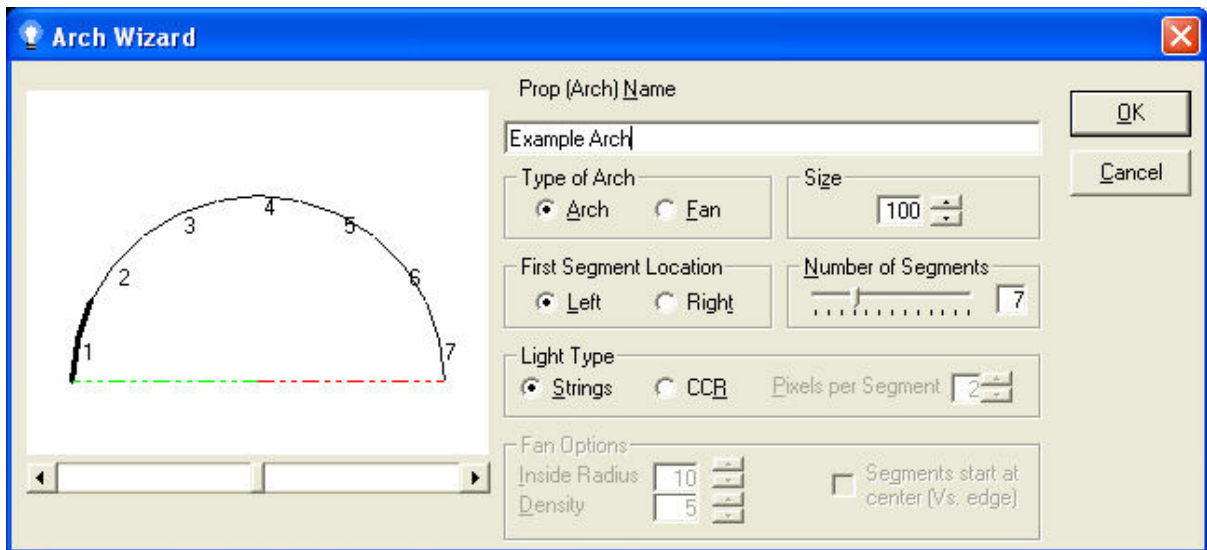

The Visualizer's Arch/Fan Wizard

Example Picture

Shows what the arch or fan will look like with the parameters you have specified.

Prop (Arch) Name

The name the [prop](#) will be given when the arch or fan is created in the editor. Any [fixtures](#) created will use this name plus a sequential number (e.g. "Example Arch 1" for the prop name "Example Arch").

Type of Arch

Allows you to choose if you are creating an arch (a semicircle of lights) or a fan (a semicircle of lights that start at the center and extend to the outside edge).

Size

Size of the arch or fan in pixels. You can always make the [prop](#) larger or smaller by using the tool handles in the editor.

First Segment Location

Allows you to control if the first arch or fan segment is created on the left side or the right side of the [prop](#).

Number of Segments

The number of separate segments the arch will consist of (1 through 16). For light strings, every segment created becomes a [fixture](#) and thus is controlled by its own set of [channels](#).

Light Type

The type of lights you will use in your simulation for this arch or fan (strings or CCR).

Pixels per Segment

If you selected the CCR light type, this option allows you to set the number of CCR pixels each segment will use. For example, a seven segment arch that uses five pixels per segment will require 35 total pixels.

Fan Options

The following options only apply to fans, and are unavailable for arches:

- [Inside Radius](#)
- [Density](#)
- [Segments Start at Center \(Vs. Edge\)](#)

Inside Radius

The size (in pixels) of the inside curve. Lights "radiate" from the outside semicircle (size) to the inside semicircle (designated by the inside size).

Density

The number of radii that each segment consists of.

Segments Start at Center (Vs. Edge)

When creating the radii, the [Visualizer](#) will normally create them with a start point on the outside semicircle inwards to the inside semicircle. Checking this box reverses that. This is handy for CCR fans when pixel order is important.

OK

Create the arch or fan.

Cancel

Close the dialog with no change.

5.12.6.3 Assign Fixtures from Wizard

This [Light-O-Rama Visualizer](#) dialog appears after finishing one of the drawing [wizards](#). On it, you can elect to create new [fixtures](#) for the entire [prop](#), or to assign the fixtures required to fixtures that already exist.

This dialog changes depending on the type of wizard being run. However, the choices are essentially the same:

- Create as many new fixtures as required (New)

- Create as many new full CCR fixtures as required (CCDs only)
- For each fixture required, ask if the drawing should be added to an existing fixture or to create a new one (Existing)

Generally speaking, you should try to create new fixtures whenever possible. An exception to this may be for CCR pixels, since they are grouped by fifty at once.

The difference between "New Fixtures" and "New Full CCR Fixtures":

When creating CCD devices, the Visualizer can create the fixture in two different ways. Full CCD fixtures create the minimum number of fixtures required, where each fixtures will be a full (50 pixel) CCD, while the generic "New Fixtures" will create one fixture for each region, and then set the starting pixel for each.

In general, the generic "New Fixtures" is easier to use for editing within the simulation, but does require extra care to ensure they are set up correctly. Full CCD fixtures more correctly represent a physical CCD device, but editing them is much harder.

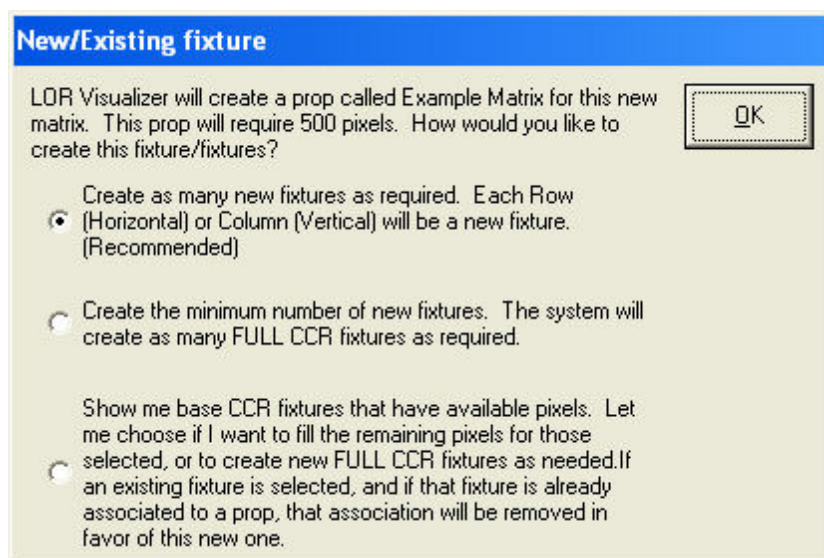

The Visualizer's Assign Fixtures From Wizard

5.12.6.4 Assign to Fixture

This [Light-O-Rama Visualizer](#) dialog is presented after finishing a new drawing, or after using a drawing [wizard](#) and specifying that you want to choose to add existing [fixtures](#). You can only ever assign a drawing to a like fixture. For example, you cannot attach a string drawing to a flood fixture - only to other string fixtures.

Fixture Dropdown

This dropdown lists all compatible [fixtures](#) that this new drawing can be added to, as well as an option to create a new fixture.

OK

Add the drawing to the selected [fixture](#), or create a new one.

Cancel

Cancel the drawing.

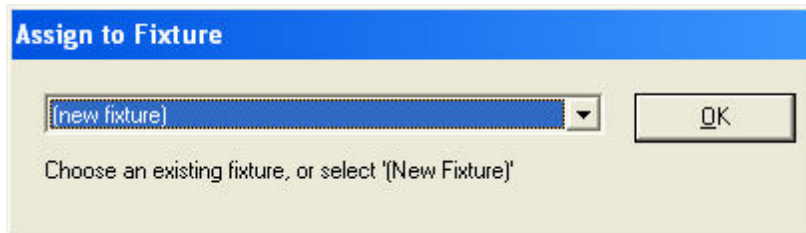

The Visualizer's Assign to Fixture dialog

5.12.6.5 CCR Matrix Wizard

This [Light-O-Rama Visualizer](#) dialog allows you to create a matrix of CCR pixels, much like a jumbotron. You first select the tool from the editor and then draw a rectangular area. When the area is drawn, this dialog appears, allowing you to set the parameters.

- [Example Picture](#)
- [Prop \(Matrix\) Name](#)
- [Start Matrix At](#)
- [Consecutive Pixels Run](#)
- [Number of CCR Pixels](#)
- [Light Size](#)
- [OK](#)
- [Cancel](#)

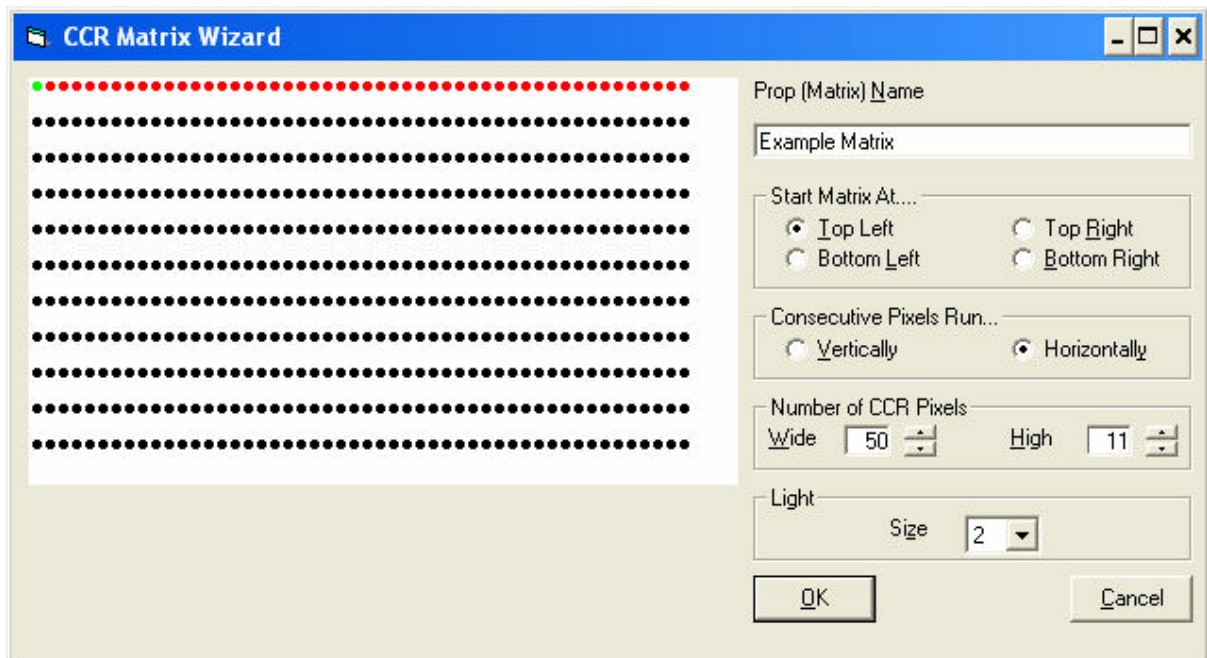

The Visualizer's CCR Matrix Wizard

ExamplePicture

Shows what the matrix will look like with the parameters you've specified. The colors shown here are to help you with the orientation of the matrix:

- **Green Pixel:** The very first pixel that will be created (starting pixel).
- **Red Pixels:** The pixels that comprise the first row (horizontally) or the first column (vertically).
- **Black Pixels:** All remaining pixels.

Prop (Matrix) Name

The name the [prop](#) will be given when the matrix is created in the editor. Any new [fixtures](#) created will use this name plus a sequential number (e.g. "Example Matrix - CCR 1").

Start Matrix At

Determines where the first pixel of this matrix will be created (top left, top right, bottom left, or bottom right).

Consecutive Pixels Run

Determines how the pixels run from the first pixel (either vertically or horizontally).

Number of CCR Pixels

How wide and high the CCR matrix will be, in pixels.

Light Size

The physical size of the CCR pixels as rendered in the Visualizer.

OK

Create the matrix with the supplied parameters.

Cancel

Discard changes.

5.12.6.6 Change Size

This [Light-O-Rama Visualizer](#) dialog is accessed from the [Simulation Properties dialog box](#) after pressing the Change Size button. This dialog allows you to change the size of the [background](#), as well as resize and reposition any existing [fixtures](#).

- [Original Size](#)
- [New Size](#)
- [Maintain Aspect Ratio](#)

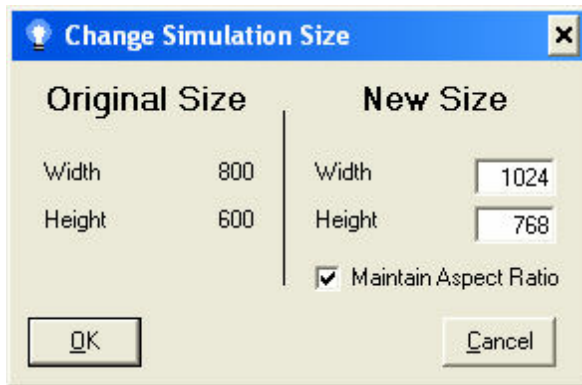

The Visualizer's Change Simulation Size dialog

Original Size

Displays the current size of the simulation in pixels.

New Size

The updated size you wish to use for the simulation.

Maintain Aspect Ratio

When checked, any change to either the height or width will automatically change the other field proportionally. For example, if the original size of your simulation was 800 by 600 - a ratio of 4 to 3 - changing the width to 1024 will automatically change the height to 768, maintaining the ratio of 4 to 3. If this is unchecked, you can change the fields independently.

5.12.6.7 Channel Assignment Wizard

The [Light-O-Rama Visualizer's](#) Channel Assignment Wizard helps to quickly assign [channels](#) to complex [props](#):

- [Channel Assignment Wizard: Non-CCR Fixtures](#)
- [Channel Assignment Wizard: CCR Fixtures](#)

5.12.6.7.1 Channel Assignment Wizard: Non-CCR Fixtures

The [Light-O-Rama Visualizer's](#) Channel Assignment Wizard helps to quickly assign [channels](#) to complex [props](#), and is accessed from the [third tab](#) of the [Prop Properties box](#).

The Channel Wizard is only available for props that have one or more assigned [fixtures](#), and where all fixtures are of the same type. If you have assigned two or more different fixtures -- for example a String fixture and a Flood Light fixture -- to the same prop, the Channel Wizard cannot be used.

The Channel Wizard can quickly create new channels, or assign channels that you have previously loaded via a [reference file](#).

In all cases, once you have specified the required options, the Next button will take you to the next step in the process, while the Previous button will take you back one step.

The OK button becomes available once you have completed all the necessary steps, and Cancel will close the dialog with no changes.

The exact steps necessary to use this wizard depend on whether you are using new channels or reference channels, but the first two steps are the same in either case:

- [Step 1](#)
- [Step 2](#)
- [Step 3 \(for new channels\)](#)
- [Step 4 \(for new channels\)](#)
- [Step 5 \(for new channels\)](#)
- [Step 6 \(for new channels\)](#)
- [New Channels Summary](#)

- [Step 1](#)
- [Step 2](#)
- [Step 3 \(for reference channels\)](#)
- [Step 4 \(for reference channels\)](#)
- [Reference Channels Summary](#)

Step 1

- **What Kind of Channels:** Select if you will be assigning normal [channels](#) to the [fixtures](#), or a set of RGB channels.
- **Set/Reset RGB Sample Color to Default:** If you selected RGB channels, selecting this box will reset the sample color to the default you specified in the options dialog. Otherwise, the sample color will not be changed.

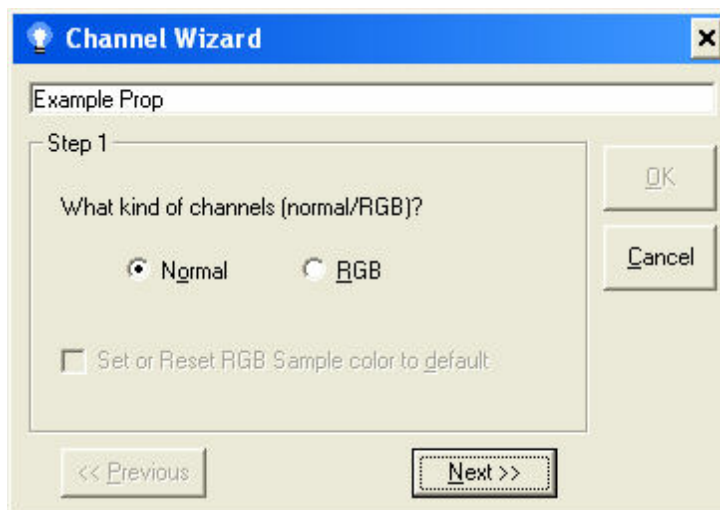

Step 1

Step 2

Use loaded [reference channels](#), or create new ones:

If you have previously loaded a [sequence](#) file or [channel configuration file](#), you can choose to use the channels from it, or to create new [channels](#) from scratch.

Depending on your selection, the wizard will present different options: [Step 3 \(for new channels\)](#) or [Step 3 \(for reference channels\)](#).

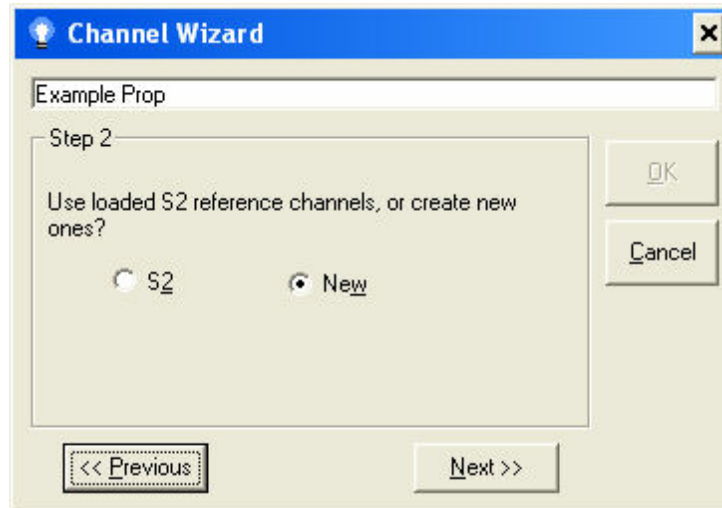

Step 2

Step 3 (for new channels)

This dialog begins the data collection for the [channels](#) you will be creating. Every [fixture](#) assigned to this [prop](#) will be given the same quantity, type, and color channels, in the same order.

- **Number of Repeating Channels Per Fixture:** The number of channels each fixture will have.
- **Create a Color Sequence:** Select the color of each channel by clicking on the numbered box, and then selecting a color.



Step 3 for new channels

Step 4 (for new channels)

- **Device Type:** Select the type of [device](#) each of these [channels](#) will emulate.
- **What LOR Addressing Mode Should Be Used:** If you selected the [LOR device type](#), then these radio buttons are active. They allow you to choose between Normal addressing (256 max [circuits](#) per [unit](#)) and Legacy addressing (16 max circuits per unit).

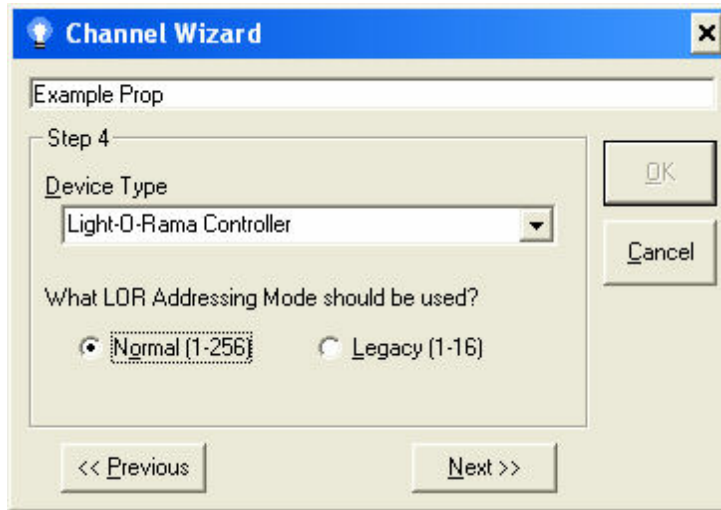

Step 4 for new channels

Step 5 (for new channels)

When the wizard runs out of circuits on a unit (*Automatically use next unit / Prompt me*):

While assigning [circuits](#) to [channels](#), there may not be enough circuits on any one [unit](#) to satisfy the total number of channels needed. If you select Automatic, once the [Visualizer](#) runs out of circuits on a unit, it will continue on to the next channel by incrementing the unit ID and setting the circuit back to 1 (or whatever the first valid circuit of this device type is).

If, however, you select "Prompt me", then when the system runs out of circuits, a dialog box will appear allowing you to select the next unit / circuit that the Visualizer should use.

Use the same channels on every fixture of this prop: There may be times when you want to duplicate the channels being created across all the fixtures rather than sequentially increment them. If you check this box, each fixture will get an identical copy of the channels created.



Step 5 for new channels

Step 6 (for new channels)

This is the last step for non-CCR [fixtures](#) that are using new [channels](#).

- **Select the starting address for the first channel of the first fixture:** These dropdown boxes allow you to set the first address of the first [channel](#) of the first [fixture](#) associated with this [prop](#). Depending on the [device type](#) selected, one or more of these fields may not be available (since they don't apply to the device selected). Once you have set the address and pressed OK, the [Visualizer](#) will assign the channels to the fixtures.

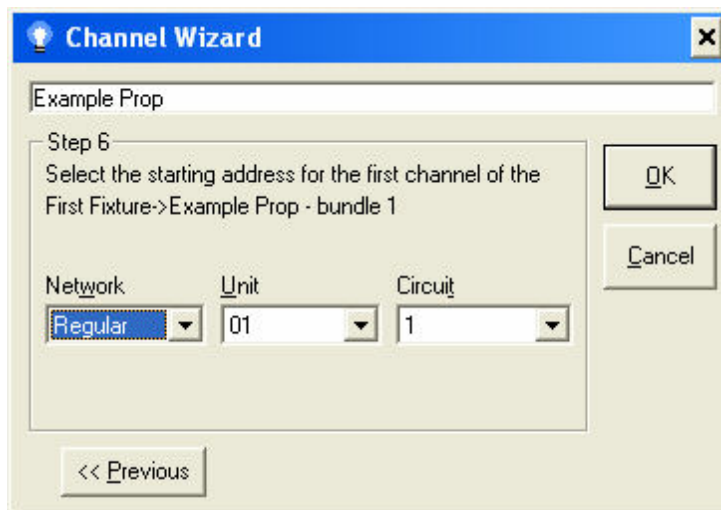

Step 6 for new channels

New Channels Summary

To assign new [channels](#), the system will update every [fixture](#) of a [prop](#) in the order that they are assigned to the prop. For each fixture, the system will create the number of channels specified in [step 3](#), in the color order specified. The first channel created on the first fixture will use the parameters you specified in [step 6](#). For each channel created after that, the system will increment

the previous [circuit ID](#) by 1. If the system runs out of circuits for a particular [unit](#), it will automatically increment the unit ID by one, and reset the circuit ID to one (or whatever the minimum for the appropriate device type is) if "Automatically use the next unit" was selected in [step 5](#), or a prompt will appear if "Prompt me" was selected in step 5. If you checked "Use the same channels on every fixture of this prop", the second and subsequent fixtures will get the same channels as the first one.

Step 3 (for reference channels)

- **Number of Repeating Channels Per Fixture:** The number of [channels](#) each [fixture](#) will have.
- **When the wizard runs out of circuits on a unit (*Automatically use next unit / Prompt me*):** While assigning [circuits](#) to [channels](#), there may not be enough circuits on any one [unit](#) to satisfy the total number of channels needed. If you select Automatic, once the [Visualizer](#) runs out of circuits on a unit, it will begin assigning channels with the next loaded [reference channel](#) unit. If the system runs out of units for a particular [device type](#) or [network](#), you will be prompted.

If, however, you select "Prompt me", then whenever the system runs out of circuits, a dialog box will appear, allowing you to select the next reference channel that the Visualizer should use.

- **Use the same channels on every fixture of this prop:** There may be times when you want to duplicate the channels being created across all the fixtures rather than sequentially increment them. If you check this box, each fixture will get an identical copy of the channels created.

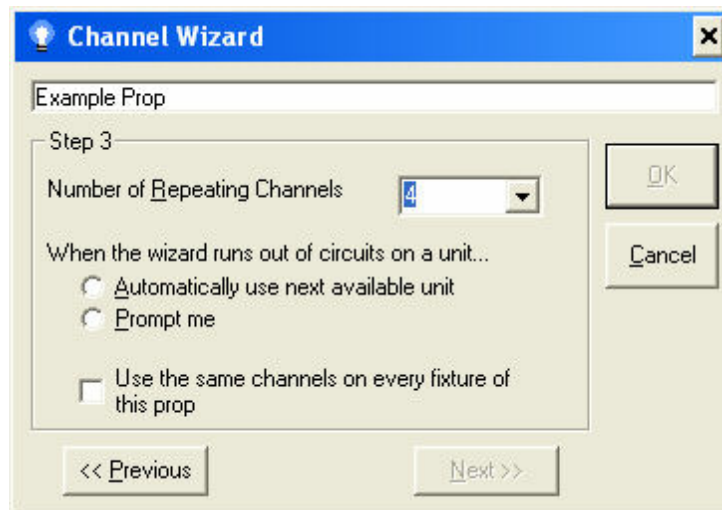

Step 3 for reference channels

Step 4 (for reference channels)

This is the last step for non-CCR [fixtures](#) that are using [reference channels](#).

- **Select first reference channel:** The [Visualizer](#) will sort all the loaded [reference channels](#) into order by [device type](#), [network](#), [unit](#), and [circuit](#). The system will then assign [channels](#) in the order that they are sorted.

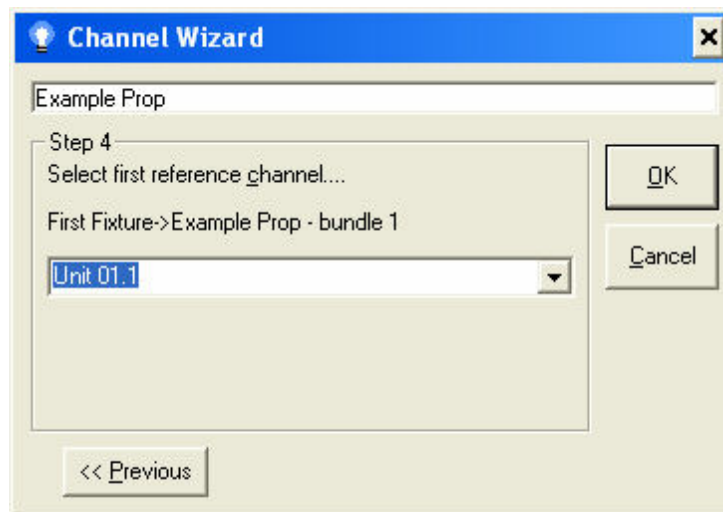

Step 4 for reference channels

Reference Channels Summary

To assign [reference channels](#), the system first sorts all [channels](#) into [device type](#), [network](#), [unit](#), and [circuit](#) order. The system will then update every [fixture](#) of a [prop](#), in the order they are assigned to the prop. For each fixture, the system will create the number of channels specified in [step 3](#). The first channel created on the first fixture will be the one selected on [step 4](#). For every channel after that, the system will assign the next loaded and sorted reference channel. If you specified "Automatically use next unit", the system will continue to assign the next loaded reference channel until the wizard completes, or the system runs out of channels with the device type or network of the channel you selected in step 4. On the other hand, if you specified "Prompt me" on step 3 and the next unit to be assigned is different, or if you ran out of circuits for a particular device type or network, you'll be presented with a dialog to select the next reference channel to be used. If you checked "Use the same channels on every fixture of the prop", the second and subsequent fixtures will get the same channels as the first one.

5.12.6.7.2 Channel Assignment Wizard: CCR Fixtures

The [Light-O-Rama Visualizer's Channel Assignment Wizard](#) for CCR [fixtures](#) is a simple, one-step process that repeats for each CCR assigned to a [prop](#).

For each CCR assigned to a prop, the CCR settings dialog is presented, which allows you to set the most important parameters of each CCR:

- [Physical Starting Pixel Number](#)
- [Network](#)
- [Base Unit ID](#)

- [Unit ID Mode](#)
- [Channel Mode](#)
- [Resolution](#)

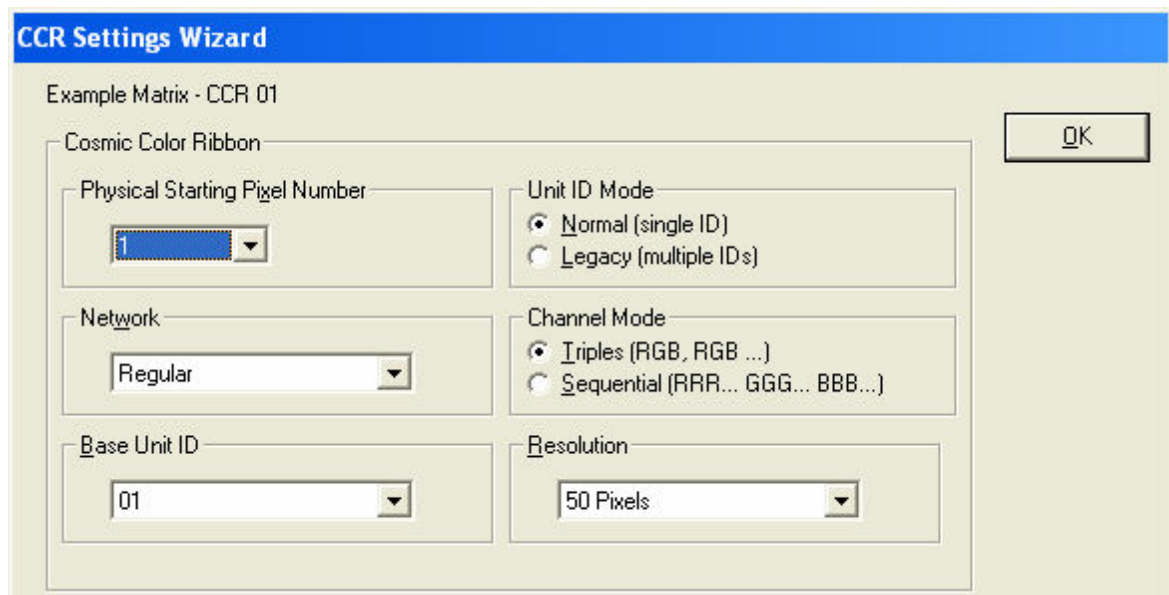

The Visualizer's Channel Assignment Wizard when used for CCR fixtures

Physical Starting Pixel Number

CCR [fixtures](#) can be split apart into separate entities. The fixture with a particular address with pixel #1 is considered the [master, and any others the slaves](#).

Network

The [network](#) this CCR is part of.

Base Unit ID

The [unit ID](#) of this CCR. For every CCR assigned after the first one, the system will attempt to guess the next unit ID to be used. You should check and change it as needed.

Unit ID Mode

Normal (one [unit](#) per CCR) or legacy (ten units per CCR).

Channel Mode

If the [channels](#) are in triplet (RGB) order or sequential order.

Resolution

The logical resolution this CCR is running at.

5.12.6.8 Channel Settings Dialog

This [Light-O-Rama Visualizer](#) dialog allows you to specify the specifics for a [channel](#) assigned to a [fixture](#).

- [Name](#)
- [Select Reference Channel \(...\)](#)
- [Select RGB Reference Channel \(RGB\)](#)
- [Device Type](#)
- [Network/Unit/Circuit](#)
- [Special Type](#)
- [Special Parameter](#)

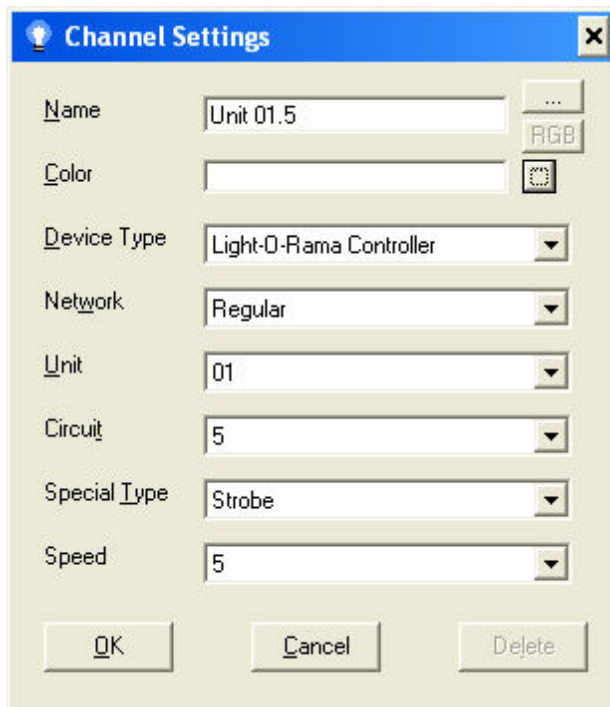

The Visualizer's Channel Settings dialog

Name

The name of the [channel](#). Required.

Select Reference Channel (...)

If you have loaded one or more [reference files](#), this button is available. Pressing it and selecting a [channel](#) from the dropdown will assign the loaded parameters to this [Visualizer](#) channel.

Select RGB Reference Channel (RGB)

If you have loaded one or more [reference files](#), if the file contained [RGB channels](#), and if you specified that this [fixture](#) use RGB channels, then this button is available. Pressing it and selecting a channel from the dropdown will assign the loaded parameters to this [Visualizer](#) channel. The system will then prompt you if you also wish to assign the other two related channels.

Device Type

Select the [device type](#) this [Visualizer channel](#) is emulating.

Network/Unit/Circuit

These fields should match your [sequence's channel](#) for this particular [fixture](#). One or more of these fields may not be available depending on the type of device you selected above.

Special Type

Certain [fixture](#) and [channel](#) types can use special effects. Currently the [Visualizer](#) supports two special types: Strobe and Multi Color. A strobe channel emulates a "strobe light" - bulbs on this channel will flash quickly on and off randomly. A [multi color](#) channel will display up to five bulbs when a channel is turned on. You cannot individually control the bulbs.

Special Parameter

If you selected a [special type](#) above, this field allows you to specify any needed additional parameters. If you selected "Strobe" above, this field allows you to set the "speed" of the strobe effect. If you selected "Multi Color", you will be able to choose the number of colors, and the actual colors themselves.

5.12.6.9 Draw CCR Wizard

To use the [Light-O-Rama Visualizer's](#) CCR Wizard, select the CCR Wizard tool and then draw a path on the editor screen along which you would like the pixels to be created. Once you double click, this dialog appears.

- [Prop \(CCR\) Name](#)
- [How Many Pixels should Visualizer create for this drawing?](#)
- [OK](#)

Prop (CCR) Name

The name the [prop](#) will be given when the CCR is created in the editor. Any new [fixtures](#) created will use this name plus a sequential number (e.g. "Example Prop - CCR 1").

How Many Pixels should Visualizer create for this drawing?

Select the number of pixels that your drawing consists of.

OK

Once you press the OK button, the system will create as many pixels as you specified, along the path that you drew. You will then be presented with the [Assign Fixtures from Wizard dialog](#).

5.12.6.10 Duplicate Channel Reference

While loading one or more [reference files](#) into the [Light-O-Rama Visualizer](#), the system may detect that a duplicate [channel](#) is being loaded with a different name or color. This dialog allows you to resolve the conflict.

The left side shows the channel as it was previously loaded. The right side shows how the channel is defined in the currently loading file. You have four options:

- [Keep Old Reference](#)
- [Use New Reference](#)
- [Keep ALL Old References](#)
- [Use ALL New References](#)

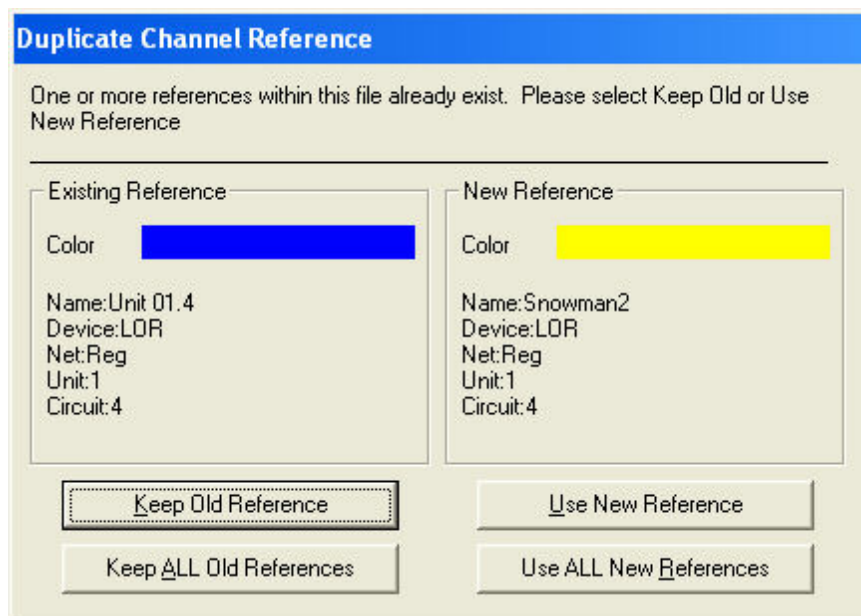

Duplicate Channel Reference

Keep Old Reference

The reference on the left side will remain, and the one on the right is discarded. If another duplicate is loaded, you will be prompted again.

Use New Reference

The reference on the right side will replace the one on the left. If another duplicate is loaded, you will be prompted again.

Keep ALL Old References

The reference on the left side will remain, and the one on the right is discarded. From this point forward, any duplicates, for this [channel](#) or others, are ignored in the file being loaded.

Use ALL New References

The reference on the right side will replace the one on the left. From this point forward, any duplicates, for this [channel](#) or others, will replace what was previously loaded.

5.12.6.11 Duplicate RGB Channel Reference

While loading one or more [reference files](#) into the [Light-O-Rama Visualizer](#), the system may detect a duplicate [RGB channel](#) being loaded with a different name or mismatched colors. This dialog allows you to resolve the conflict.

The left side shows the RGB channel as it was previously loaded. The right side shows how the RGB channel is defined in the currently loading file. You have four options:

- [Keep Old Reference](#)
- [Use New Reference](#)
- [Keep ALL Old References](#)
- [Use ALL New References](#)

Duplicate RGB Triplet Reference

One or more RGB triplet references within this file already exist. Please select Keep Old or Use New Reference

Existing Reference	New Reference
<p>Color </p> <div style="border: 1px solid gray; padding: 5px; margin-top: 5px;"> Name:New RGB (R) Device:LDR Net:Reg Unit:1 Circuit:1 </div>	<p>Color </p> <div style="border: 1px solid gray; padding: 5px; margin-top: 5px;"> Name:New RGB (R) Device:LDR Net:Reg Unit:1 Circuit:1 </div>
<p>Color </p> <div style="border: 1px solid gray; padding: 5px; margin-top: 5px;"> Name:New RGB (G) Device:LDR Net:Reg Unit:1 Circuit:2 </div>	<p>Color </p> <div style="border: 1px solid gray; padding: 5px; margin-top: 5px;"> Name:New RGB (G) Device:LDR Net:Reg Unit:1 Circuit:2 </div>
<p>Color </p> <div style="border: 1px solid gray; padding: 5px; margin-top: 5px;"> Name:New RGB (B) Device:LDR Net:Reg Unit:1 Circuit:3 </div>	<p>Color </p> <div style="border: 1px solid gray; padding: 5px; margin-top: 5px;"> Name:New RGB (B) Device:LDR Net:Reg Unit:1 Circuit:3 </div>
<input type="button" value="Keep Old Reference"/>	<input type="button" value="Use New Reference"/>
<input type="button" value="Keep ALL Old References"/>	<input type="button" value="Use ALL New References"/>

Duplicate RGB Channel Reference

Keep Old Reference

The reference on the left side will remain, and the one on the right is discarded. If another duplicate is loaded, you will be prompted again.

Use New Reference

The reference on the right side will replace the one on the left. If another duplicate group is loaded, you will be prompted again.

Keep ALL Old References

The reference on the left side will remain, and the one on the right is discarded. From this point forward, any duplicates, for this [RGB channel](#) or others, are ignored in the file being loaded.

Use ALL New References

The reference on the right side will replace the one on the left. From this point forward, any duplicates, for this [RGB channel](#) or others, will replace what was previously loaded.

5.12.6.12 Fixture Properties

This [Light-O-Rama Visualizer](#) dialog allows you to set various parameters for a [fixture](#). This includes things like the name, [channels](#) assigned, bulb size and shape, et cetera. Each different type of fixture (strings, floods, etc.) has different requirements, so some sections may or may not be visible and some fields may not be available, depending upon the type of the fixture.

- [Name](#)
- [Type](#)
- [Comment](#)
- [Part of Prop](#)
- [Level](#)
- [Locked](#)
- [Number of Points](#)
- [Virtual Bulbs](#)
- [Flood Light](#)
- [Channel Type](#)
- [Assigned Channels](#)
- [Cosmic Color Ribbon](#)

Name

The name of the [fixture](#). This descriptive name can be shown on the [editor window](#), and is presented in the [object selection area](#). The system will attempt to create a unique name for new fixtures. It is not, however, required that all names be unique.

Type

This is the type of [fixture](#). It cannot be changed.

Comment

Use this field to add any comments about the [fixture](#). This field is not used by the system; it is only here to help with your design, and can be used any way you see fit. For example, you may want to track the total number of amps this fixture will draw, what it is built from, et cetera.

Part of Prop

If this [fixture](#) is part of a [prop](#), then the prop is listed here. If the fixture is not assigned to a prop, "(None)" is displayed. You can also assign or remove this fixture from a prop by clicking on the dropdown list.

Level

The [layer](#) this [fixture](#) currently resides on.

Locked

[Locked fixtures](#) cannot be selected in the [main editing area](#). This prevents accidental changes to the fixture. The lock can be enabled or disabled here as well as in the [object selection area](#).

Number of Points

The current number of vertices (for string fixtures) or number of bulbs (for single bulbs/CCRs/floods) that this [fixture](#) consists of. String fixtures can have a maximum of 256 vertices (with unlimited bulbs), or 256 bulbs for CCRs, floods, and single bulb fixtures.

Virtual Bulbs

The Virtual Bulbs section allows you to specify the parameters of the bulbs being generated, as well as see a sample representation of those bulbs. Depending on the [fixture](#) type, some fields may not be available. For example, you cannot change the spacing or the shape of the bulbs of a CCR fixture.

- **Size:** The size of the bulbs that will be used for this [fixture](#) in the simulation.
- **Spacing:** For string [fixtures](#), this is the amount of space between two consecutive bulbs.
- **Shape:** Some [fixture](#) types allow you to use different bulb shapes - round, square, triangle, various star shapes, et cetera.
- **Sample Bulbs:** This area gives you a representation of what the bulbs will look like, based upon the parameters you have specified. If you have defined normal [channels](#) for this [fixture](#), the sample will show how the bulbs will appear in the channel colors defined. If you have specified that this fixture uses RGB channels, then the color used will be the "RGB Sample Color". From left to right, the sample shows the bulbs from full intensity to lower intensities.
- **Background Color:** When you first create a [fixture](#), the system will use the background color as specified in the options dialog. However, this background may make the bulbs hard to see. Pressing this button will allow you to specify a different background color just for this fixture.
- **RGB Sample Color:** Since the color of the bulbs for this [fixture](#) is not fixed, this button allows you to quickly specify the color of the bulbs while editing. It is best to use a color here that you don't normally see on your stage, so that you can quickly identify those elements that are RGB. If you would like more control over the sample color, you can also use the sliders to the right of the button. These sliders allow you to specify the R, G, and B components separately.

Flood Light

For flood light fixtures, this section replaces the "[Virtual Bulb](#)" section.

- **Max Opacity:** Flood lights are generally used to "wash" areas with light. This wash is not opaque, since you can still see what is being lit by the flood light. The Visualizer attempts to

simulate this by allowing you to set the maximum opacity of a flood light. Normally, if a light is turned on to 100%, the entire background will be obscured by the light. If, however, you specify a maximum opacity of less than 100%, then no matter how bright the [channel](#) is turned on, some of the background will still show through.

- **Size:** The size of the flood light.
- **Background Color:** When you first create a [fixture](#), the system will use the background color as specified in the options dialog. However, this background may make the bulbs hard to see. Pressing the button will allow you to specify a different background color just for this fixture.
- **RGB Sample Color:** Since the color of the bulbs for this [fixture](#) is not fixed, this button allows you to quickly specify the color of the bulbs while editing. It is best to use a color here that you don't normally see on your stage, so that you can quickly identify those elements that are RGB. If you would like more control over the sample color, you can also use the sliders to the right of the button. These sliders allow you to specify the R, G, and B components separately.

Channel Type

Depending on the [fixture](#) type, you can specify that this fixture uses either normal or RGB [channels](#). Clicking on any row here will bring up the [channel settings](#) for that particular channel. This section does not appear for CCRs since they are always RGB and are assigned channels differently.

Assigned Channels

Depending on the type of [fixture](#) and the type of [channels](#), this section allows you to specify up to 16 different channels. Clicking on a row here will bring up the [Channel Settings dialog box](#).

Cosmic Color Ribbon

This section only appears if this is a CCR [fixture](#).

- **Physical Starting Pixel Number:** CCR fixtures can be split apart into separate entities. The fixture with a particular address with pixel #1 is considered the master, and any others the slaves.
- **Network:** The [network](#) that this CCR is a part of.
- **Base Unit ID:** The base [unit ID](#) of this CCR.
- **Unit ID Mode:** Normal (one [unit](#) per CCR) or Legacy (ten units per CCR).
- **Channel Mode:** If the [channels](#) are in triplet (RGB) order, or sequential. Only available for the master CCR.
- **Resolution:** The logical resolution this CCR is running at. Only available for the master CCR.

5.12.6.13 Insert Symbol Fixture

This [Light-O-Rama Visualizer](#) dialog allows you to create a [fixture](#) that is shaped like a character from a symbol font.

- [Font Name](#)
- [Sample Area](#)
- [Selection Area](#)
- [# of Points](#)
- [OK](#)
- [Cancel](#)

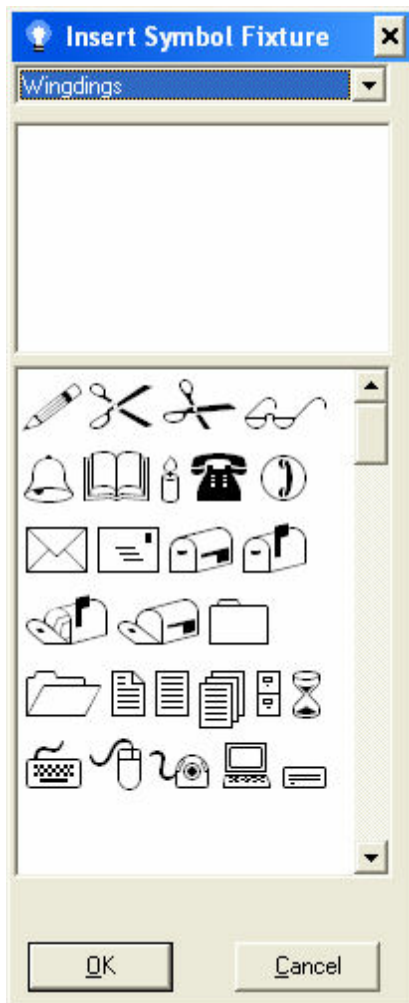

Insert Symbol Fixture

Font Name

Allows you to select the font from which you would like to select a character.

Sample Area

Shows a larger version of the selected character.

Selection Area

Allows you to select the character that will become a [fixture](#).

of Points

The [Visualizer](#) can only use [fixtures](#) that have less than 256 points. If the selected character has more than 256 points, this field will be red, and the character cannot be used. Otherwise, the area will be green.

OK

Create the [fixture](#) using the selected character as an outline.

Cancel

Close the dialog with no changes.

5.12.6.14 Level Visibility and Properties

In the [Light-O-Rama Visualizer](#), a [fixture](#) can be placed on any of sixteen [levels](#), from the background (level 1) to the foreground (level 16). The primary use of levels is to allow you to layer fixtures on your [stage](#). When you simulate your show, fixtures are rendered in background to foreground order. This means that fixtures on higher levels, when turned on, will seem to "cover" those on lower levels. You can disable the simulation of certain layers so that you can better see areas that may be hidden. You can also disable editing on certain layers to help you create your stage.

- [Name](#)
- [Enabled for Editing](#)
- [Enabled for Simulation](#)
- [All/None/Invert](#)
- [When Editing Show Fixtures on Disabled Levels at This Intensity](#)

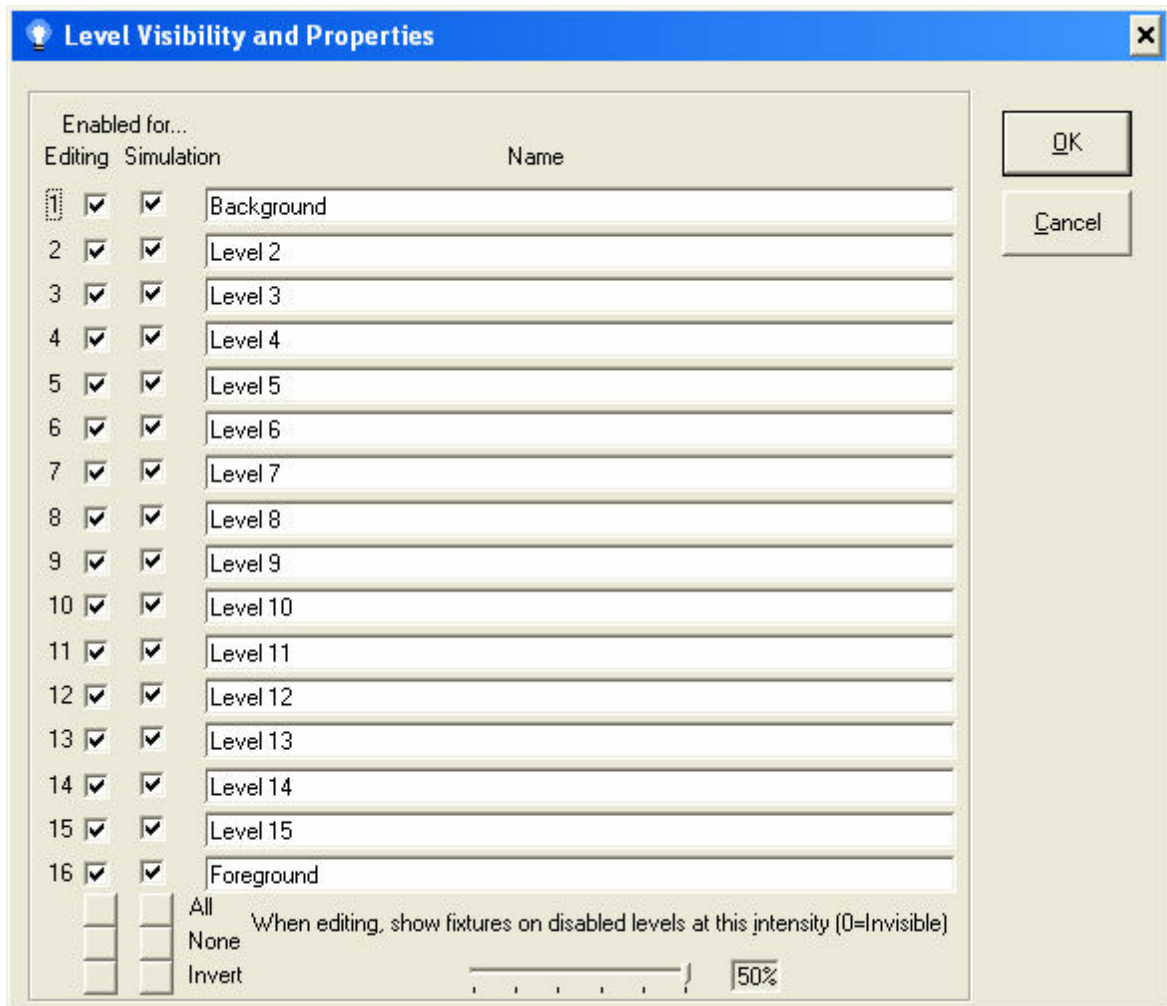

Level Visibility and Properties

Name

You can rename the [levels](#) as you see fit.

Enabled for Editing

There is one checkbox for each [level](#) that enables or disables [fixtures](#) on that level for editing. When unchecked, fixtures that are on this particular level are shown at a lower intensity (or invisible), and cannot be selected in the [main editor window](#). They can, however, still be selected in the [object list](#).

Enabled for Simulation

There is one checkbox for each [level](#) that enables or disables the simulation of [fixtures](#) on that particular level. When unchecked, fixtures on this level are not simulated (and are therefore invisible) while being controlled by the [Sequence Editor](#) or [Show Player](#).

All/None/Invert

There are two sets of buttons here - one each for editing and simulation. Selecting one of these commands quickly changes the state of all the checkboxes of that particular type.

- **All:** All checkboxes are checked.
- **None:** All checkboxes are unchecked.
- **Invert:** Checkboxes that were checked are now unchecked, and those that were unchecked are checked.

When Editing Show Fixtures on Disabled Levels at This Intensity

When a [fixture](#) is on a [level](#) that is disabled, it is presented in the editor window at a lower intensity. This slider allows you to select what that intensity is, from 50% down to 0% (with 0% meaning it is invisible).

5.12.6.15 Load LOR Reference File

The [Light-O-Rama Visualizer's](#) Load LOR Reference File dialog allows you to quickly assign [channels](#) to [fixtures](#), using one or more [sequence](#) files or [channel configuration files](#) as [reference files](#).

To load a reference file, first click the "select file" button ("..."). Select the sequence or channel configuration file that you would like to use, and then press the "Load" button. The Visualizer will then load the file that you selected and merge it with any other reference files you may have loaded.

When you select "Done", you are given the option to update any existing fixtures with the loaded references. If you select "yes", the Visualizer will match the existing channels of your simulation to the ones loaded, and update the name and color of each if a match is found.

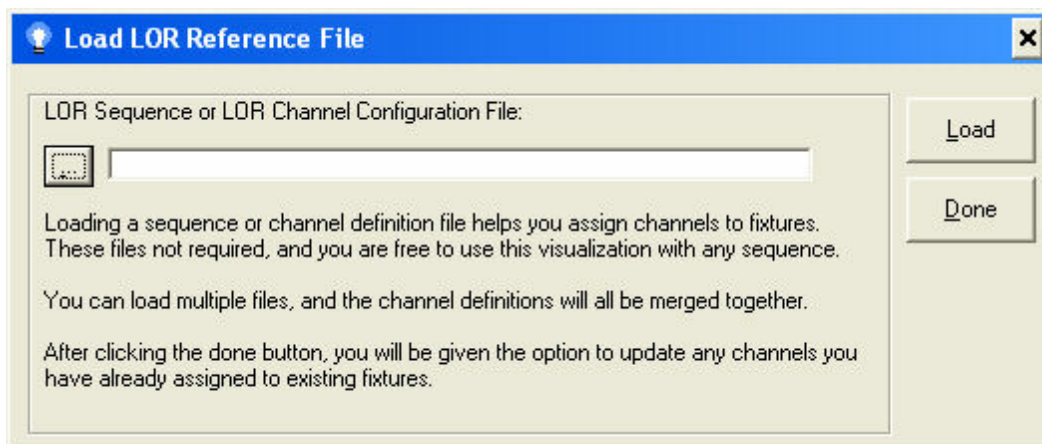

Load Reference File

5.12.6.16 Main Editing Window

This area in the [Light-O-Rama Visualizer](#) is where you will be doing all drawing and manipulation of [fixtures](#) and [props](#). It is the [stage](#) on which you will create your fixtures and props.

5.12.6.17 Main Editor Window

The [Light-O-Rama Visualizer's](#) main editor window consists of these areas:

- The [menu](#)
- The [toolbars](#)

- The [main editing window](#)
- The [object list](#)
- The [status bar](#)

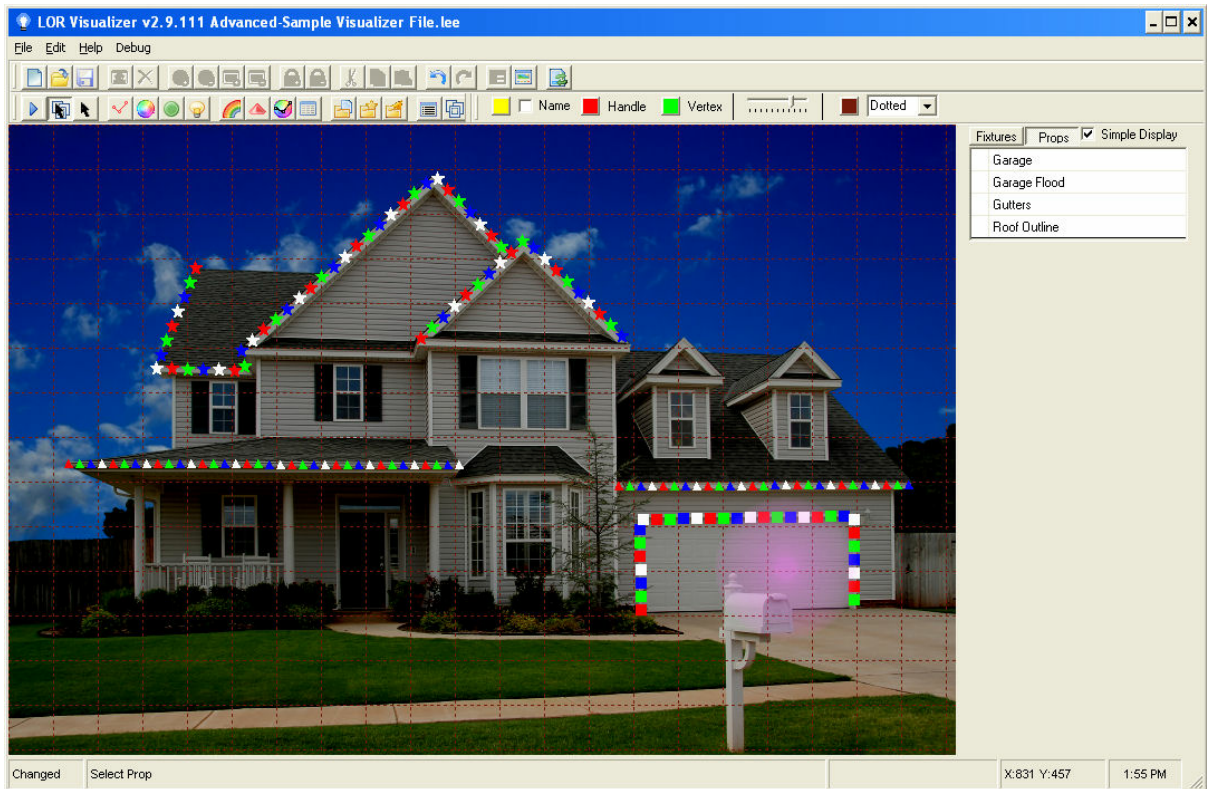

The Visualizer's main editor window

5.12.6.18 Menu Items

The [Light-O-Rama Visualizer's](#) menus allow you to choose most of the commands that are available in the Visualizer. The following main menus exist:

- **File:** File related tasks, including load, save, and program options.
- **Edit:** Editor related tasks: tools, wizards and the like.
- **Help:** Show the help file.

5.12.6.19 New Prop

This [Light-O-Rama Visualizer](#) dialog allows you to create a new [prop](#). A prop must first be created before it can be assigned to one or more fixtures. After naming the prop, the [Prop Properties box](#) is shown.

- [Name](#)
- [OK](#)
- [Cancel](#)

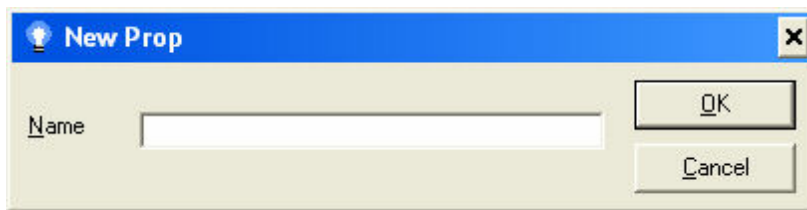

The New Prop dialog

Name

The name of this new [prop](#).

OK

Create the [prop](#).

Cancel

Discard changes.

5.12.6.20 New Simulation

The [Light-O-Rama Visualizer's](#) New Simulation dialog allows you to create a simulation with the parameters you specify. You can change these parameters later, with the "Simulation Properties" dialog.

- [Background](#)
- [OK](#)
- [Cancel](#)

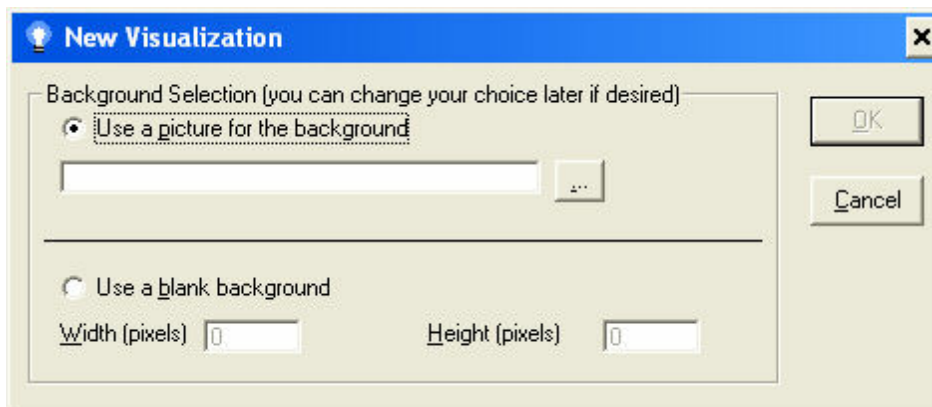

The Visualizer's New Simulation dialog

Background

Select if you would like to use a picture or a plain solid white [background](#) for your simulation. If you select "Picture", you must use the "select file" button ("...") to select your background graphic. If you select "Blank", you must specify a width and height in pixels.

OK

Once the dialog is correctly completed, the OK button becomes available. When selected, it creates the new visualization with the parameters you have specified.

Cancel

Dismisses the dialog without any changes.

5.12.6.21 Object Selection Area

This area in the [Light-O-Rama Visualizer](#) shows you the names of all [fixtures](#) or [props](#) in your simulation. The area has several display modes and changes depending on whether you are working with fixtures or props. While in prop mode, you have the option of using a "normal" or "simple" display:

- **Normal:** This is a two-line display where the top line is the [prop](#) and the bottom line is the [fixture](#). Every fixture is shown on the list.
- **Simple:** This is a one-line display where only the [prop](#) name is shown in the list.

5.12.6.22 Options

The [Light-O-Rama Visualizer's Options](#) dialog allows you to change the parameters, defaults, and behaviors of the Visualizer. The Options dialog has these tabs:

- [General](#): General Visualizer parameters including autosaving, name display, et cetera.
- [Tooltips](#): When pointing at an object in the editor, the Visualizer can show you information about the [prop](#) or [fixture](#). This tab allows you to control what is displayed.
- [Colors](#): The system colors used.
- [Fixtures](#): Defaults for creating [fixtures](#) and [props](#).
- [Bulbs](#): Defaults for bulbs and [channels](#).
- [Com/Ref](#): Defaults for communication and [reference files](#).

5.12.6.22.1 Options Tab 1: General

This tab on the [Light-O-Rama Visualizer's Options dialog](#) controls general Visualizer parameters including autosaving, name display, et cetera:

- [On Startup](#)
- [Auto Save Every](#)
- [When Deleting a Fixture or Prop](#)
- [Show Fixture/Prop Name](#)
- [Show CCR Pixel Order Numbering](#)
- [Always Show Prop Name](#)
- [Ignore Missing Background Pictures](#)
- [Use Simple Prop Display](#)
- [Close Window \(X\) Stops Simulation](#)
- [Don't Show Corrupt File Warning](#)

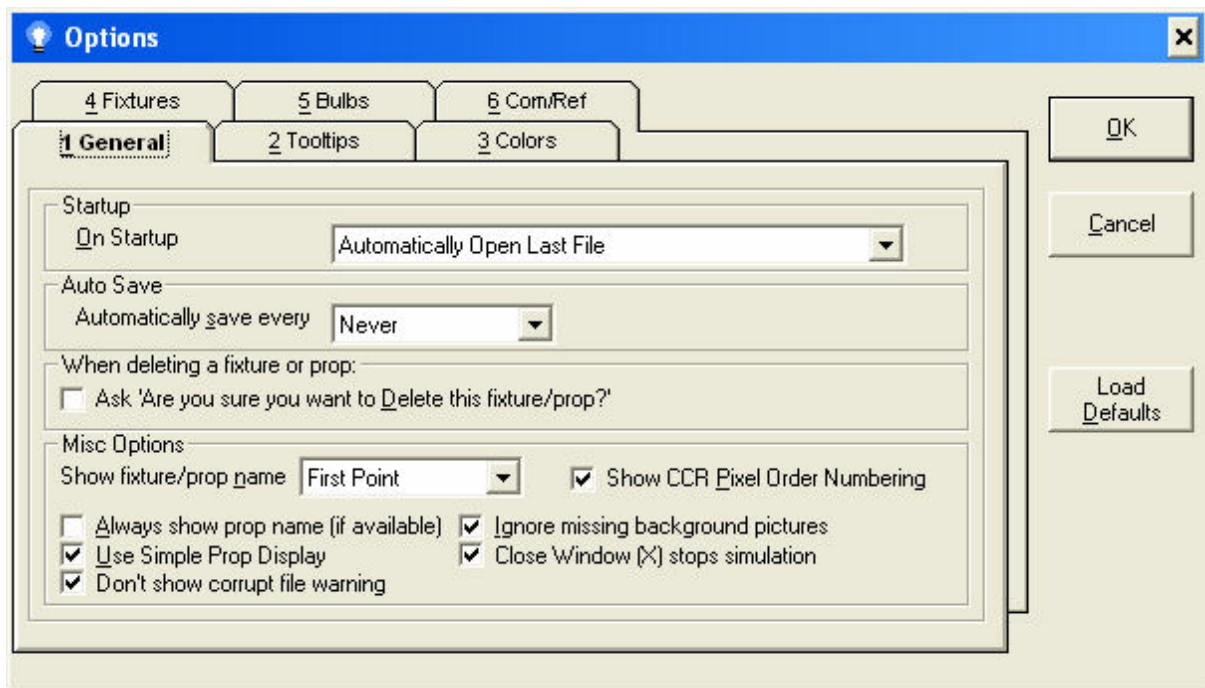

The General Options tab

On Startup

Controls the behavior of the Visualizer when it starts up. The options are: do Nothing, Show Open File Dialog, Automatically open last file.

Auto Save Every

By setting this field to something other than "Never", the [Visualizer](#) will automatically save a visualization file periodically.

When Deleting a Fixture or Prop

Controls if the system will prompt you before allowing a delete.

Show Fixture/Prop Name

By setting this field to something other than "None", the name of a [fixture](#) or [prop](#) will be shown on the [main editor screen](#) (in the drawing area).

Show CCR Pixel Order Numbering

Along with the [fixture](#) name, the [Visualizer](#) can display the number of each pixel of a CCR. Pixel numbers are important, since the order of them is important for simulation. This option controls if that pixel number is displayed or not.

Always Show Prop Name

The name displayed near an object is normally controlled by what mode the user is in: While in fixture mode, [fixture](#) names are displayed, and while in prop mode, [prop](#) names are displayed. Selecting this checkbox forces the [Visualizer](#) to always show the prop name if it is available, regardless of the mode.

Ignore Missing Background Pictures

If selected, the system will not prompt the user if it cannot find the background graphics.

Use Simple Prop Display

The [object list](#) can be set to display in two different ways while in [prop](#) mode:

- **Normal:** Every [fixture](#) is displayed in a two-line list, with the first line being the [prop](#) name and the second line being the fixture name.
- **Simple:** Only the [prop](#) name (or the [fixture](#) name if the fixture is not assigned to a prop) is displayed.

Close Window (X) Stops Simulation

Selecting this option means that if you attempt to close a simulation with the window's control box, only the simulation will stop and the application will remain active.

Don't Show Corrupt File Warning

The system digitally signs all editor save files. If a file is loaded with a signature that does not match, the system will warn the user that the file may be corrupted. Selecting this option ignores the error.

5.12.6.22.2 Options Tab 2: Tooltips

This tab on the [Light-O-Rama Visualizer's Options dialog](#) controls whether or not tooltips are displayed on the [main editor screen](#) and, if they are displayed, how they are displayed. Tooltips can give you a quick way of looking at a [fixture](#) or [prop's](#) parameters and data.

- [Show Fixture/Prop Tooltips in Edit Mode](#)
- [Show Fixture Properties Even in Prop Mode](#)
- [Show the Following for Fixtures](#)
- [Show the First 'x' Assigned Channels](#)
- [Show the Following for Props](#)
- [Display up to 'x' Associated Fixtures](#)

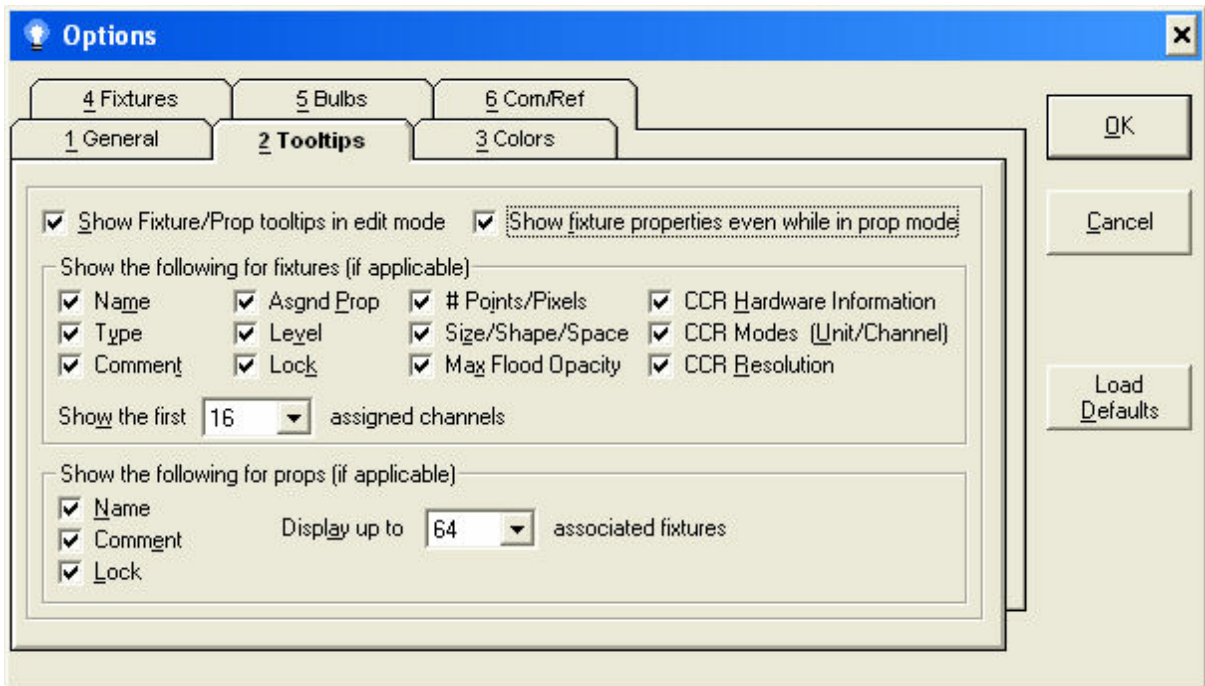

The Tooltips Options tab

Show Fixture/Prop Tooltips in Edit Mode

Turns tooltips on or off.

Show Fixture Properties Even in Prop Mode

When pointing at an object in the editor in [prop](#) mode, the prop parameters are displayed. If this option is checked, the [Visualizer](#) will show [fixture](#) properties regardless of what mode the editor is in.

Show the Following for Fixtures

Various fields that the user may or may not feel are important. If you don't want to see a particular parameter in the tooltips, unselect it.

Show the First 'x' Assigned Channels

If you set this value to something other than "None", the system will display this number of defined [channels](#), starting with the first.

Show the Following for Props

Various fields that the user may or may not feel are important. If you don't want to see a particular parameter in the tooltips, unselect it.

Display up to 'x' Associated Fixtures

If set to a value other than "None", the system will show the names of this many [fixtures](#) associated to a [prop](#), starting with the first.

5.12.6.22.3 Options Tab 3: Colors

This tab on the [Light-O-Rama Visualizer's Options dialog](#) controls what system colors the Visualizer uses, and the defaults for [fixtures](#):

- **Tool Handle:** Tool handle colors.
- **Vertex Handle:** Drawing vertices tool handles.
- **Fixture/Prop Names:** Color of the text used to display a [fixture](#) or [prop](#) name.
- **Default Background Color:** The color used for the sample [background](#) when a new [fixture](#) is created.
- **Default RGB Sample Color:** The color used for the RGB [fixture](#) when a new one is created.
- **Show fixtures in color while in edit mode:** When checked, the [Visualizer](#) will attempt to use the channel colors or sample RGB color for [fixtures](#). When unchecked, black is used.

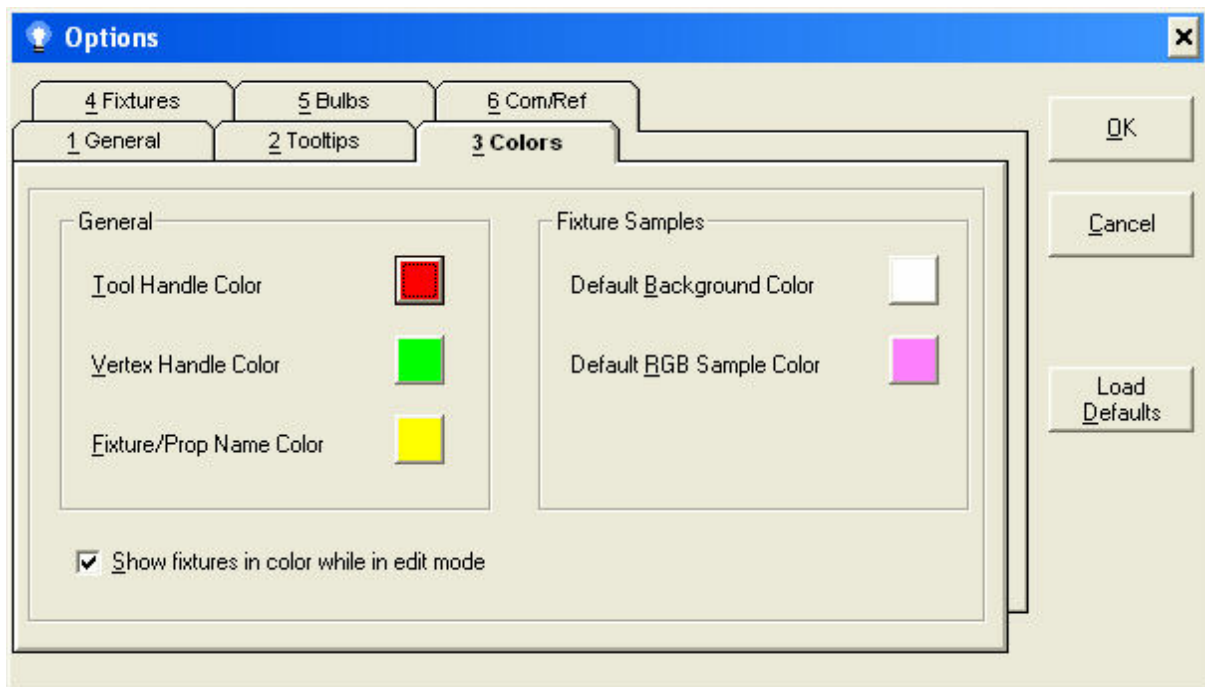

The Colors Options tab

5.12.6.22.4 Options Tab 4: Fixtures

This tab on the [Light-O-Rama Visualizer's Options dialog](#) allows you to specify defaults and parameters when working with [fixtures](#) or [props](#).

- **When creating new fixtures assume the fixture is new:** When set to "Ask", the system will present the "[Assign to Fixture](#)" dialog box, where you can select to create a new [fixture](#) or to use an existing fixture for a newly created drawing. When this option is set to "Always", the system

creates a new fixture and never prompts.

- **Default channel type:** When creating a new [fixture](#), the [channel](#) type will automatically be set to this type where applicable.
- **Automatically Show the Fixture Properties Box After:** You can control when the system automatically shows the [fixture](#) properties after the following actions: creating a new fixture, adding points to an existing fixture, selecting a fixture in the editor, selecting a fixture in the object list, undo/redo of fixture properties.
- **Automatically Show the Prop Properties Box After Using a Wizard to Create 2 or More Fixtures:** If you use a [wizard](#) to create a [prop](#), if that prop contains more than two [fixtures](#) and you have selected this option, the [Prop Properties dialog](#) will be shown.

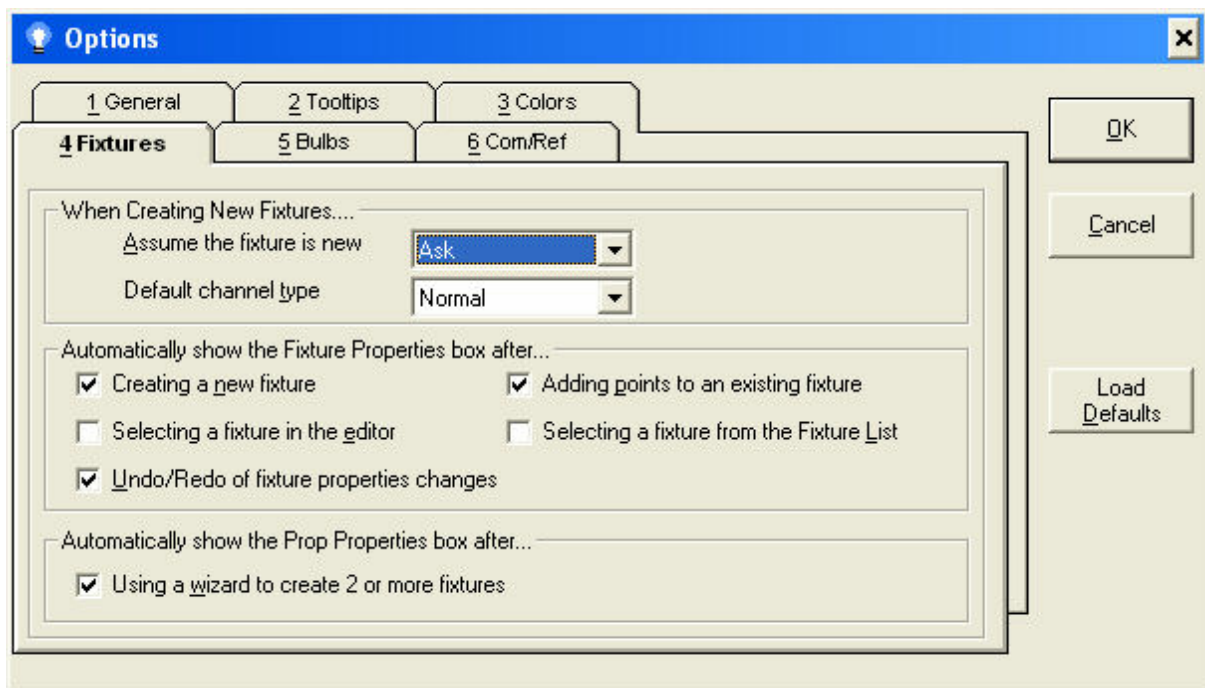

The Fixtures Options tab

5.12.6.22.5 Options Tab 5: Bulbs

This tab on the [Light-O-Rama Visualizer's Options dialog](#) controls the defaults and actions associated with virtual bulbs:

- **Defaults:** New [fixtures](#) that are created will use these parameters (as needed). You can always change them on the [fixture properties](#) later.
- **Don't show a warning if a CCR has an incorrect number of pixels:** A CCR must consist of exactly 50 pixels, or it may not be simulated correctly. Checking this box disables the warning if a CCR [fixture](#) has other than 50 pixels.
- **Don't show a warning if the bulb size is smaller than the recommended minimum:** Some bulbs have a recommended minimum size that is greater than one. Checking this box will disable the warning.

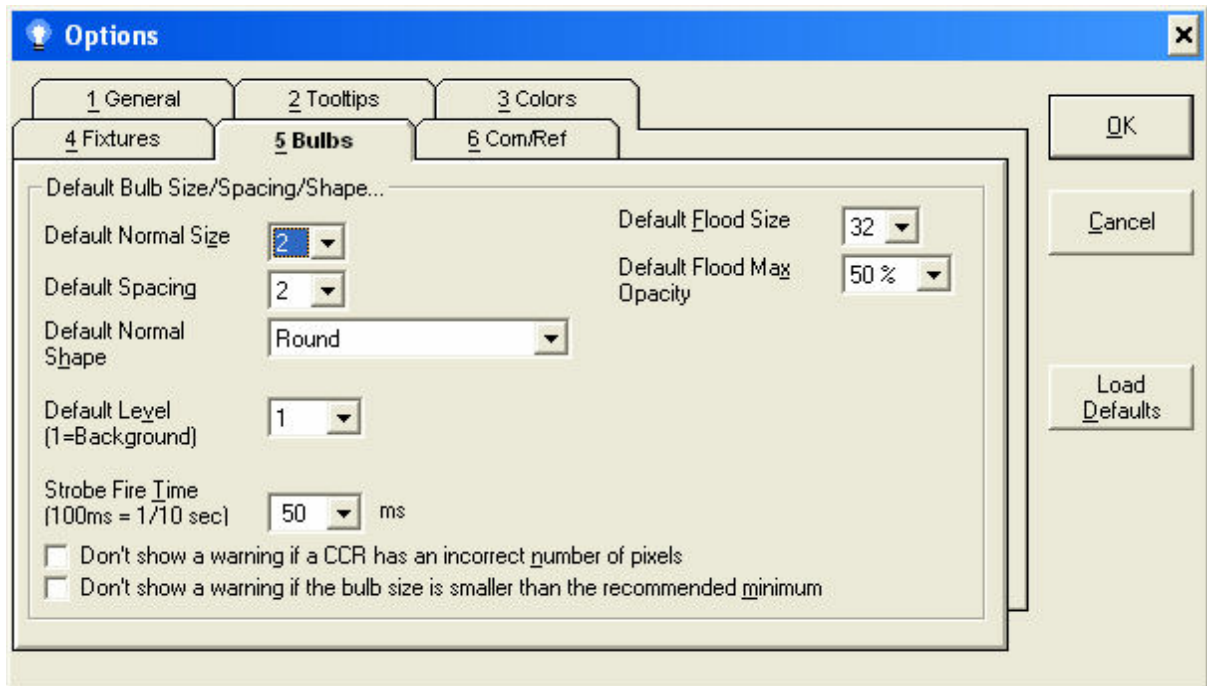

The Bulbs Options tab

5.12.6.22.6 Options Tab 6: Com/Ref

This tab on the [Light-O-Rama Visualizer's Options dialog](#) controls how the Visualizer interacts with the [Sequence Editor](#) or [Show Player](#):

- **Communications:** These fields control how the [Sequence Editor](#) or [Show Player](#) will "talk to" (control) the [Visualizer](#). Normally you will be running the Visualizer on the same computer as the Sequence Editor, so the defaults (Local and port 30303) should be OK. Advanced users may want to change these fields. In all cases, the fields here must match the Visualizer Properties in the Sequence Editor.
- **Don't show 'Load Another' reminder when loading reference files:** The system will remind you after loading a [reference file](#) that you can load as many such files as you like. Checking this box will disable this reminder.
- **OK:** Applies the changes and closes the dialog.
- **Cancel:** Discards the changes and closes the dialog.
- **Load Defaults:** You can reset how the [Visualizer](#) works to the installation defaults by clicking this button.

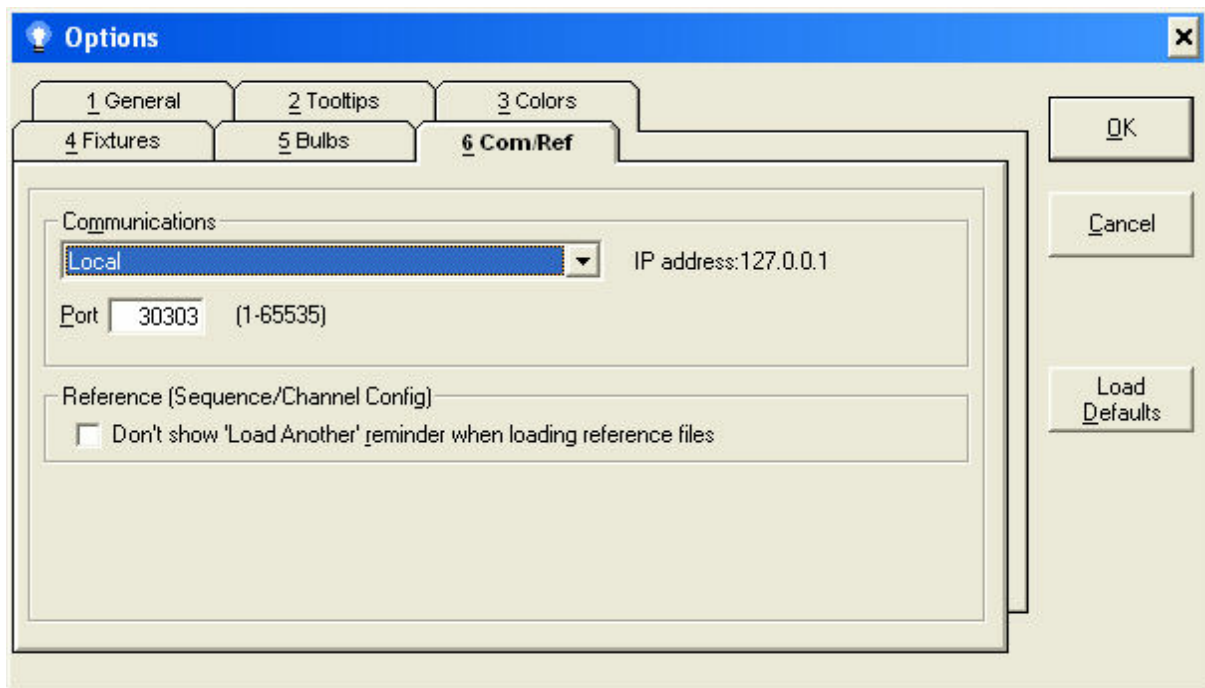

The Com/Ref Options tab

5.12.6.23 Prop Properties

The [Light-O-Rama Visualizer's Prop Properties](#) box is broken down into three tabs:

- **General:** Name, comment, and [fixtures](#) that are assigned to the [prop](#).
- **Fixture Properties:** Most used properties that can be quickly assigned to all [fixtures](#) assigned to this [prop](#).
- **Wizards:** Access to run the [Channel Wizard](#) or the [Rename Wizard](#).

Note that the Prop Properties box's "Delete" button will delete the [prop](#) definition, but will not delete any [fixtures](#) associated with the prop.

5.12.6.23.1 Prop Properties: General Tab

This tab on the [Light-O-Rama Visualizer's Prop Properties box](#) allows you to change various properties assigned to a [prop](#):

- **Name:** The name of this [prop](#).
- **Comment:** A comment area for your personal use.
- **Locked:** [Lock](#) or unlock the [prop](#). Locked props cannot be selected or edited in the [main editing window](#).
- **Export Prop File:** This button allows you to export this [prop](#) into a file library. See [Importing and Exporting Fixtures and Props](#) for more information.
- **Fixture List:** Click a row here to edit the [fixtures](#) assigned to this [prop](#).

Clicking a blank line will allow you to add a fixture.

Clicking an existing line will bring up a list of fixtures, as well as a delete button ("X") to remove the selected fixture from the prop.

If a fixture is already assigned to a prop, the fixture name is noted with an asterisk ("*") in the fixture list.

Removing a fixture from a prop does not delete the fixture.

- **Change Order of Fixtures:** Pressing this button brings up the [Reorder Prop dialog](#). This dialog allows you to change the order of the [fixtures](#) assigned to a [prop](#). you may want to change the order of fixtures before using the [Channel Wizard](#).

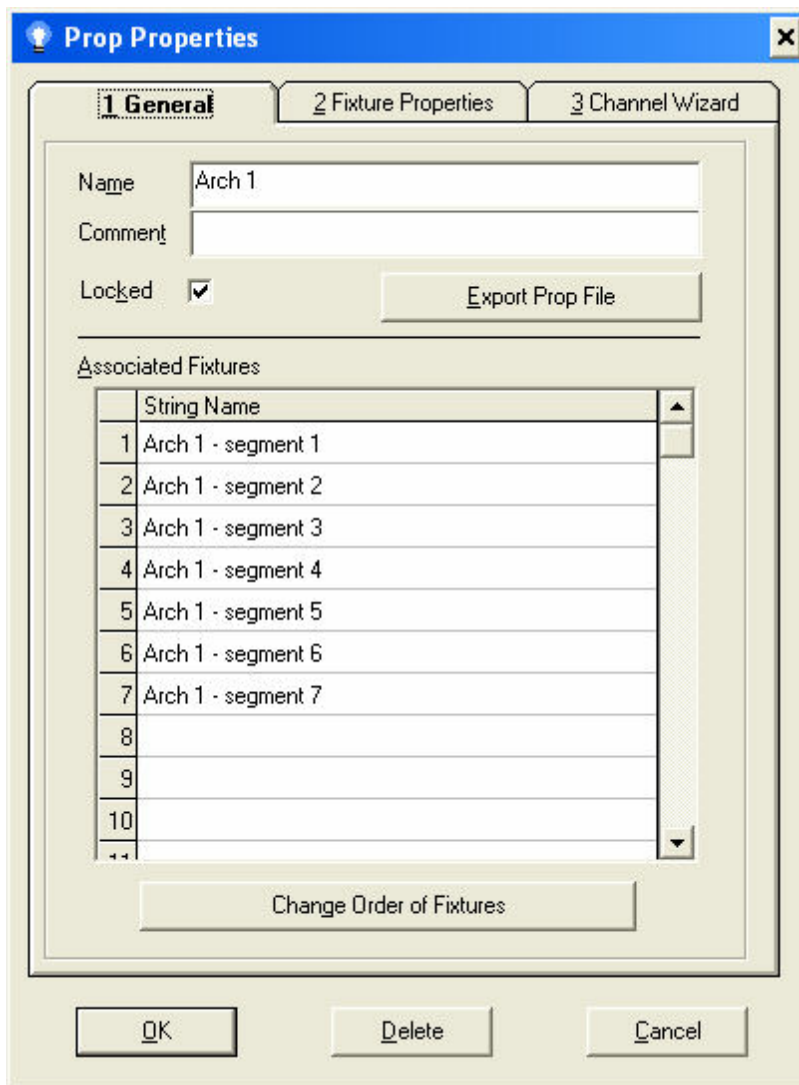

The Prop Properties General tab

5.12.6.23.2 Prop Properties: Change Fixture Properties Tab

This tab on the [Light-O-Rama Visualizer's Prop Properties dialog](#) allows you to update the most used parameters of [fixtures](#) assigned to a [prop](#). For example, you can quickly change the bulb size of all fixtures assigned to this prop.

The parameters that can be changed are: lock status, level, size, shape, spacing, flood size, and flood max opacity. For more information on what these parameters mean, please see the documentation on [Fixture Properties](#).

Depending on the parameter, not all fields are available for all fixture types. For example, "Spacing" is undefined for any fixture except "String" fixtures.

You may notice that some of the fields are blank and yet available. If a field is blank, that means two or more fixtures in this prop have different values for this field. For example, if two fixtures are attached to this prop and one has "Round" bulbs and the other "Square", the "Shape" field will be blank. If you leave the field blank, then this parameter will not be updated for any of the fixtures in the prop. If you do change a blank field, then all fixtures attached to this prop will have that parameter changed.

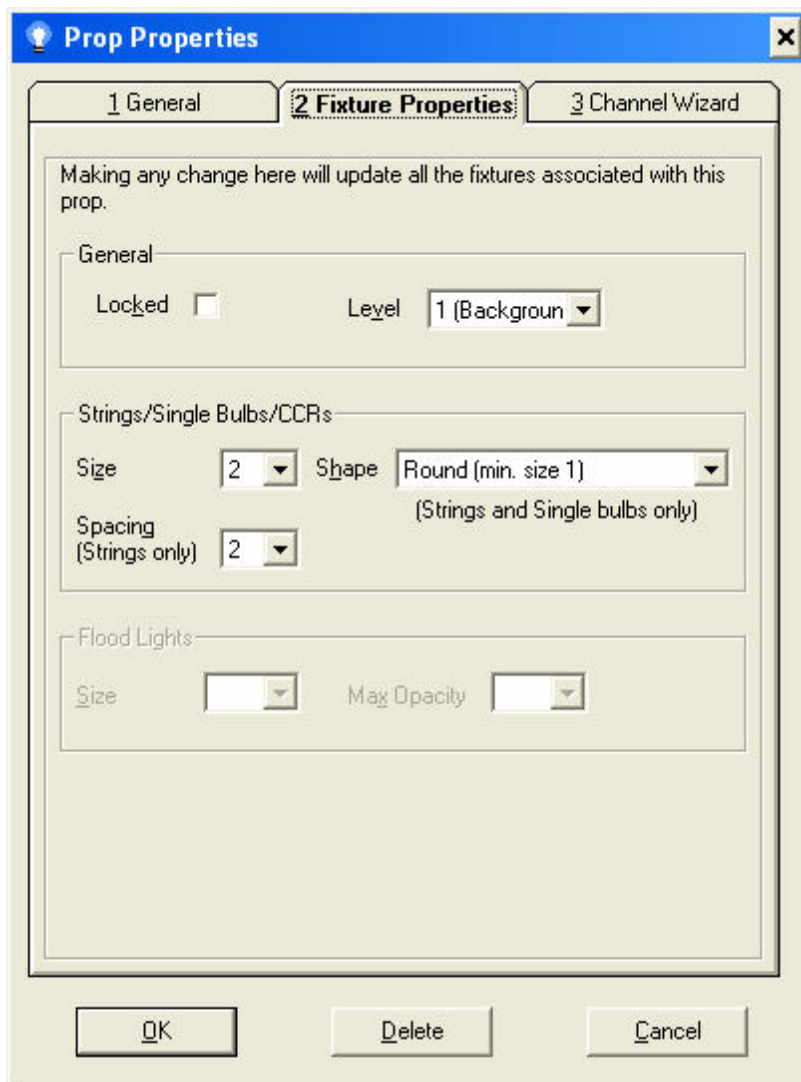

The Prop Properties Fixture Properties tab

5.12.6.23.3 Prop Properties: Wizards Tab

This tab on the [Light-O-Rama Visualizer's Prop Properties dialog](#) has buttons that allow you to run the [Channel Wizard](#) or the [Rename Wizard](#) on the [fixtures](#) of this [prop](#). The Channel Wizard is only available if the fixtures of the prop are all of the same type (e.g. all string fixtures, or all flood fixtures).

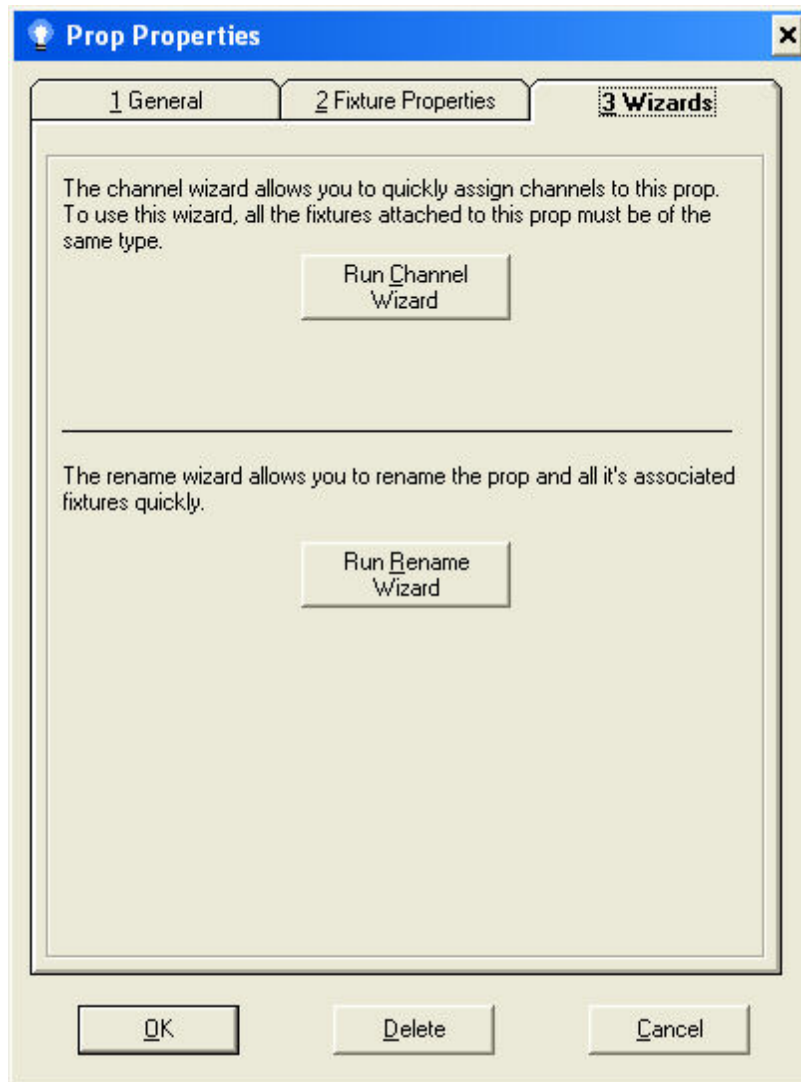

The Prop Properties Channel Wizard tab

5.12.6.24 Rename Fixture

This dialog is presented when running the Rename Wizard.

New Fixture Name: New name to assign to this fixture. This box is filled with the current name of the fixture.

5.12.6.25 Rename Prop

This dialog is presented when you run the Prop Rename Wizard, or when importing a Prop file. Depending on how the Rename Prop dialog is used, some fields may not be visible or usable.

Prop Name Options

- **Use the prop and fixture names specified in the file:** This option is only presented if you are importing a Prop file. Selecting this option disables all other options.

- **Rename the prop to:** This text box is pre-filled with the existing prop name. If this option is selected (or if it is the only option available), the "[Fixture Name Options](#)" become available. You can change the name of the [prop](#) here, or keep the existing name.

Fixture Name Options

- **Automatically rename the fixtures with the prop name and a number:** For each [fixture](#) attached to this [prop](#), this option will replace the name with the prop name and a sequence number.
- **Prompt me for the name of each fixture:** For each [fixture](#) attached to this [prop](#), present a dialog with the existing name and allow it to be changed if desired.

5.12.6.26 Reorder Prop (Change Fixture Order)

The [Light-O-Rama Visualizer's](#) Reorder Prop dialog allows you to reorder the [fixtures](#) that are assigned to a [prop](#). Typically you would want to do this before running the [Channel Wizard](#), since the wizard will assign [channels](#) starting with the first fixture running to the last.

To reorder the fixtures, simply drag them into a new order in the list.

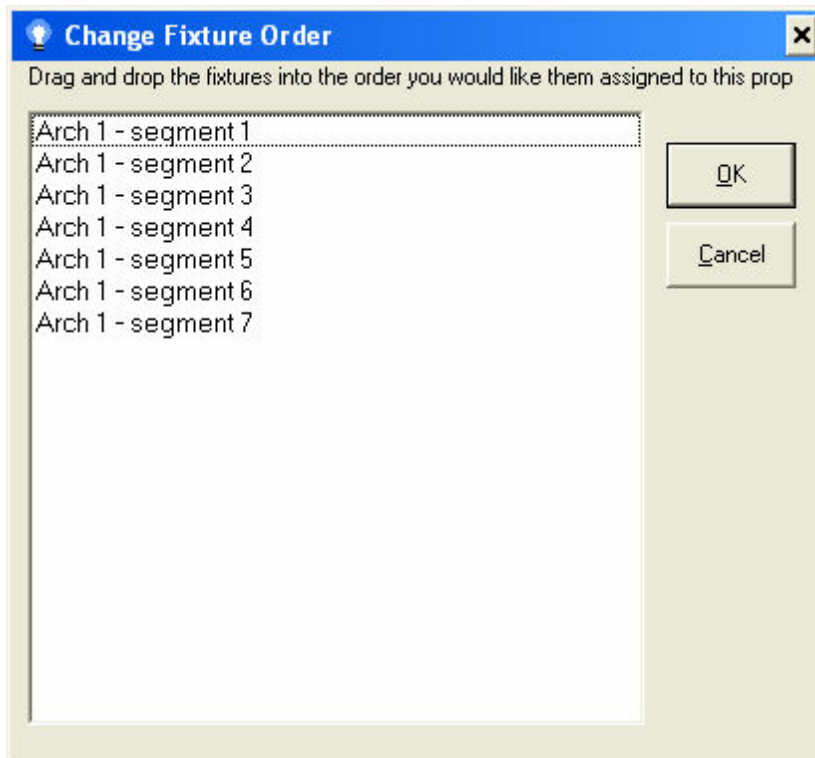

The Change Fixture Order dialog

5.12.6.27 Select Reference Channel

When you press the Select Channel Reference (...) or Select RGB Reference (RGB), this [Light-O-Rama Visualizer](#) dialog appears. The list is populated with [channels](#) of the appropriate type. Select the channel you would like to use in the dropdown.

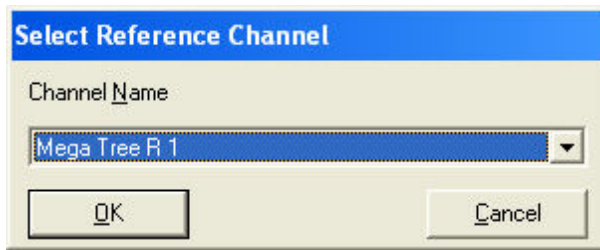

The Select Reference Channel dialog

5.12.6.28 Simulation (Background) Properties

This [Light-O-Rama Visualizer](#) dialog box allows you to change the [background picture](#), or to remove it entirely. You can also change the size of the visualization, and the intensity of the background or background picture.

- [Image Source](#)
- [None](#)
- [Image Size](#)
- [Editor Size](#)
- [New Size](#)
- [Intensity](#)
- [Grid Lines](#)
- [Grid Color](#)
- [Grid Density \(Slider\)](#)
- [OK](#)
- [Cancel](#)

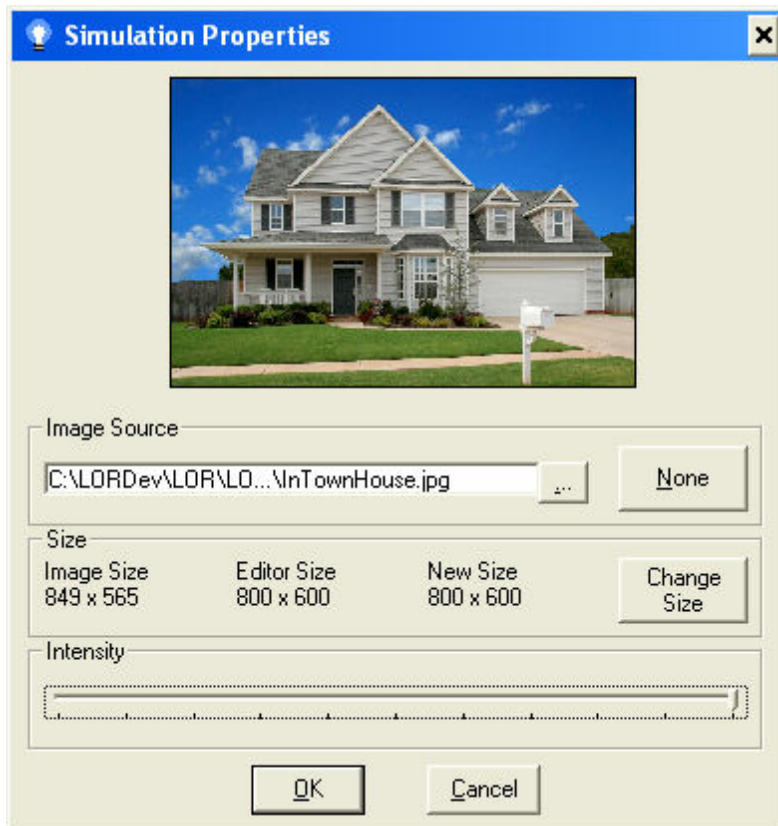

The Simulation Properties dialog

Image Source

Select your [background picture](#) using the Select File button ("...").

None

Removes the [background image](#).

Image Size

The size (in pixels) of the original [background image](#) (if loaded).

Editor Size

The size of the current visualization.

New Size

The size of the simulation if you have used the "Change size" button and then press OK.

Intensity

Controls the brightness of the [background or background graphic](#). Allows you to "turn off the lights" to see a better representation of your stage. This slider has the same effect as the one on the main editor window.

Grid Lines

A dropdown that allows you to select if a drawing grid is displayed, and if so the type of grid. The grid is not a permanent part of your simulation, and can be turned on or off at any time.

Grid Color

Color of the grid used (if any).

Grid Density (Slider)

Controls the number of grid markings displayed. More dense grids are to the left, less dense grids to the right.

OK

Apply the changes and close the dialog.

Cancel

Discard changes.

5.12.6.29 Simulation (Compile) Errors

When you start a simulation, the Visualizer compiles all your [fixtures](#) and lights to improve performance. If the Visualizer is unable to compile your sequence, this dialog will be shown.

Errors: A text box with a list of the errors encountered. These errors will need to be corrected before the simulation can run.

5.12.6.30 Status Bar

The [Light-O-Rama Visualizer's](#) status bar shows the current status of the Visualizer, plus additional information which may be helpful. It is broken down into different regions depending upon whether the Visualizer is in editing mode or simulation mode:

While Editing

1. Indicates if the simulation has changed since it was last saved.
2. Information area: additional information about a tool in use, et cetera.
3. This section is unused while editing.
4. Location of the cursor (X, Y) in the [edit window](#).
5. Current time.

While Simulating

1. Stop button: ends the simulation and returns to edit mode.
2. Information area: Additional information about the simulation.
3. FPS: Shows the current performance of the simulation.
4. Queue Gauge: Graphically shows how much information is in the queue waiting to be processed.
5. Current time.

5.12.6.31 Toolbars

The [Light-O-Rama Visualizer's](#) toolbars allow you to quickly work with the Visualizer's tools and options. There are the following toolbars:

- [Edit Toolbar](#)
- [Actions Toolbar](#)
- [Color Toolbar](#)

5.12.6.31.1 Edit Toolbar

The [Light-O-Rama Visualizer's](#) Edit Toolbar contains tools that deal with editing your visualization:

- **New:** Start a new visualization.
- **Open:** Load an existing visualization.
- **Save:** Save the current visualization.
- **Home Object:** Take the selected [fixture](#) or [prop](#) and move it to the upper left of the editing window.

- **Delete:** Delete the selected [fixture](#) or [prop](#).
- **Send to Foreground:** Place the selected [fixture](#) or [prop](#) on the [foreground](#) (level 16).
- **Send to Background:** Place the selected [fixture](#) or [prop](#) on the [background](#) (level 1).
- **Move Forward:** Move the selected [fixture](#) one [level](#) forward, towards the foreground.
- **Send Backward:** Move the selected [fixture](#) one [level](#) backward, towards the background.
- **Lock:** [Lock](#) the selected [fixture](#) or [prop](#).
- **Unlock:** [Unlock](#) the selected [fixture](#) or [prop](#).
- **Cut:** Remove the selected [fixture](#) or [prop](#) from the editor and place it on the clipboard so that it can be pasted later.
- **Copy:** Duplicate the selected [fixture](#) or [prop](#) onto the clipboard so it can be pasted later.
- **Paste:** Create another copy of the [fixture](#) or [prop](#) on the clipboard at the home position.
- **Undo:** Undo the last action.
- **Redo:** Redo the previously undone action.
- **Object Properties:** Show the properties box of the selected [fixture](#) or [prop](#).
- **Simulation Properties:** Show the properties of the simulation.
- **Load LOR Reference File:** Load a [sequence](#) or [channel configuration file](#) as a [reference file](#).

5.12.6.31.2 Actions Toolbar

The [Light-O-Rama Visualizer's](#) Actions Toolbar contains commands and actions that you can perform, including simulation, object selection, et cetera:

- **Play:** Place the [Visualizer](#) in simulation mode.
- **Select Prop:** Place the [Visualizer](#) in prop mode and allow the selection of [props](#).
- **Fixture Select:** Place the [Visualizer](#) in fixture mode and allow the selection of [fixtures](#).
- **Draw Strings:** Draw strings of lights.
- **Draw CCRs:** Draw single bulbs of a CCR [fixture](#).
- **Draw Floods:** Draw flood lights.
- **Draw Single Bulbs:** Draw single bulbs.
- **Arch Wizard:** Start the [Arch/Fan Wizard](#).
- **Tree Wizard:** Start the [Tree Wizard](#).

- **CCR Wizard:** Start the [CCR Wizard](#).
- **Matrix Wizard:** Start the [CCR Matrix Wizard](#).
- **Insert Fixture:** Import a [fixture](#) from a fixture file.
- **Insert Symbol:** Create a [fixture based upon a font character](#).
- **Insert Prop:** Import a [prop](#) from a prop file.
- **Level Properties:** Set [level](#) options and visibility.
- **Create New Prop:** Create a [prop](#) so that [fixtures](#) can be assigned to it.

5.12.6.31.3 Color Toolbar

The [Light-O-Rama Visualizer's](#) Color Toolbar contains tools that let you quickly adjust system colors and the [background](#) intensity.

- **Names:** Color of the text used to display a [fixture](#) or [prop](#) name. You can also turn off the display by unchecking the box.
- **Handle:** Tool handle colors.
- **Vertex:** Drawing vertices tool handles.
- **Background Intensity Slider:** Set the [background](#) intensity from black to normal.
- **Grid Display Color:** Color of the drawing grid displayed.
- **Grid Display Option:** Turn off the grid, or change the type of grid displayed.

5.12.6.32 Tree Wizard

This [Light-O-Rama Visualizer](#) wizard allows you to create light trees (mega trees) with either strings or CCRs. Depending on your selections, some options may not be available.

- [Example Picture](#)
- [Prop \(Mega Tree\) Name](#)
- [Size](#)
- [Type of Tree](#)
- [Type of Channel Bundles/Fixtures](#)
- [First Bundle Location](#)
- [Number of Bundles/Fixtures](#)
- [Density](#)
- [Bundle Options](#)
- [Scroll Bars](#)
- [OK](#)
- [Cancel](#)
- [Defaults](#)

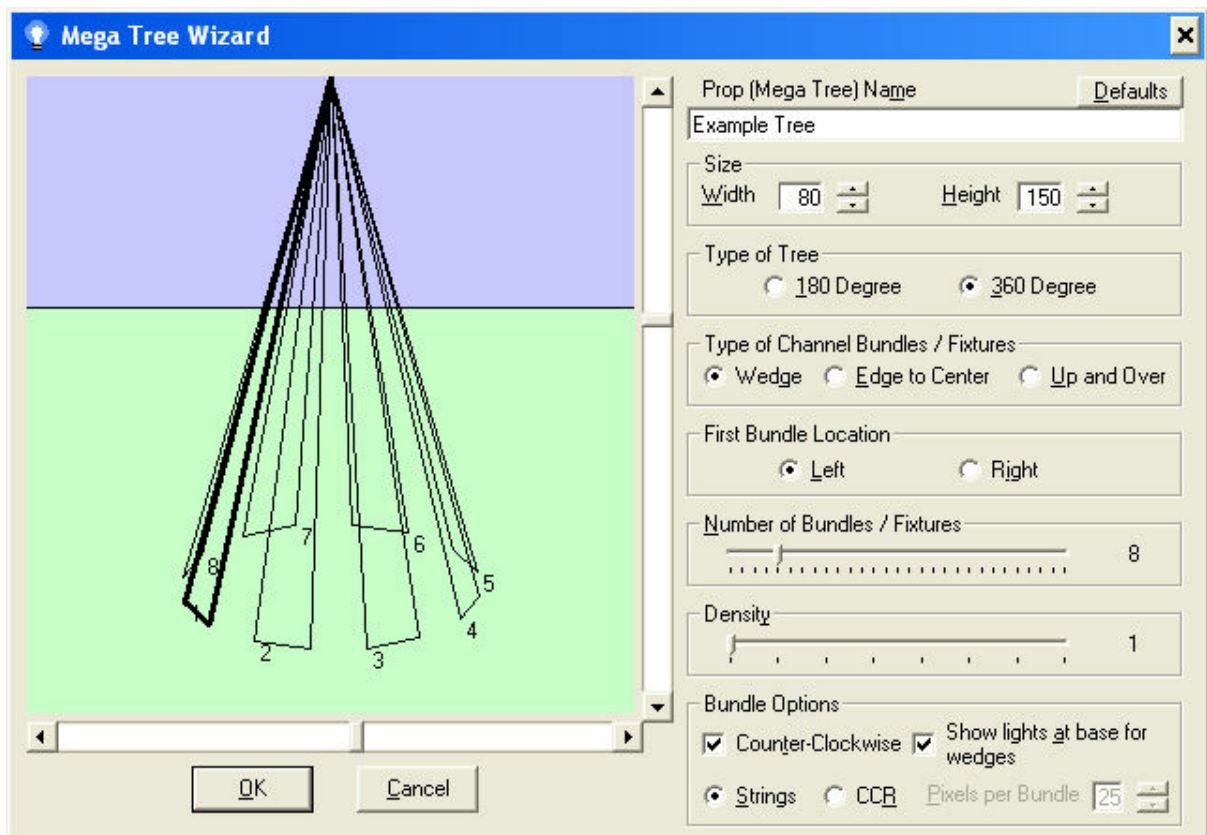

The Visualizer's Tree Wizard

Example Picture

Shows what the tree will look like with the parameters you have specified.

Prop (Mega Tree) Name

The name the [prop](#) will be given when the tree is created in the editor. Any [fixtures](#) created will use this name plus a sequence number (e.g. "Example Tree 1" for the prop name "Example Tree").

Size

The size of the tree in pixels, in both width and height. The width of the tree is the round base, while the height is the size of the center pole. You can always make the prop larger or smaller by using the tool handles in the editor after creation.

Type of Tree

The wizard can create full trees (360 degrees) or half trees (180 degrees).

Type of Channel Bundles/Fixtures

When the wizard creates the tree, each [channel](#) bundle (also called a segment) can be created in three ways:

- **Wedge:** The bundle is created by starting on the base, going to the top of the virtual center pole, and then back down to the base.
- **Edge to Center:** The bundle is created starting at the base and running to the top of the virtual center pole.
- **Up and Over:** The bundle is created starting at the base, running to the top of the virtual center pole, and then back down again directly opposite of where it started.

First Bundle Location

Allows you to control where the first bundle is created. You can further refine the starting location by using the horizontal scroll bar to "spin" the tree through the virtual center pole.

Number of Bundles/Fixtures

This slider allows you to choose how many independently controllable regions will be created. For light strings, each bundle will become a fixture.

Density

You can make the tree appear to be more full by increasing the density.

Bundle Options

These options allow further control on how the bundles/fixtures will be created:

- **Counter Clockwise:** When creating bundles, the system will normally create them from the location you specify, continuing around clockwise from that point. If you select this option, the bundles are created from your starting point, but in a counterclockwise motion instead.
- **Show lights at base for wedges:** If you are creating wedge-shaped [channel](#) bundles, enabling this option shows the lights at the base connecting the legs of the wedge.
- **Strings/CCR:** You can elect to create the tree as a CCR tree, or using light strings.
- **Pixels per Bundle:** If you are creating a CCR-based tree, this field allows you to set the number of pixels each bundle will use.

Scroll Bars

The scroll bars allow you to change the perspective of the tree to better match your stage. The vertical scroll bar allows a 180 degree view, from inside the tree looking straight up at the top of the center pole, to straight on, to above the tree looking straight down at the center pole. The horizontal scroll bar allows you to rotate the tree around the center pole. This allows you to refine the starting place of the first bundle.

OK

Create the tree.

Cancel

Close the dialog with no change.

Defaults

Resets the parameters to logical defaults if desired.

5.12.7 Mouse Wheel

You can quickly scroll several areas of the [Light-O-Rama Visualizer's main editor window](#) by using your mouse wheel. To scroll the simulation vertically, use the wheel while over the [main editing area](#). To scroll horizontally, place the cursor on the horizontal scroll bar and rotate. To scroll the [object list](#), point at it and use the wheel.

5.12.8 Shortcut Keys

Along with the [Light-O-Rama Visualizer's menu shortcuts](#), accessed with the Alt key and the underlined letter, there are several keyboard shortcuts that can be used in the editor:

Delete key	Delete the currently selected fixture or prop .
Home key	Send the currently selected fixture or prop to the upper left corner of the editor.
Ctrl-C	Copy.
Ctrl-V	Paste.
Ctrl-X	Cut.
+	Move the selected fixture or prop towards the foreground .
-	Move the selected fixture or prop towards the background .
Tab key	Select the next fixture or prop .

5.13 Verifier

The Light-O-Rama Verifier can be used to check for certain types of problems with the way that Light-O-Rama is configured on your machine, and with your [schedule](#), [shows](#), and [sequences](#).

To use the Verifier, simply click its "Verify" button. As it is checking for issues, it will display what it is doing in its "Output Log" tab; when it is complete, it will switch to its "Results" tab, showing a list of the issues that it has found:

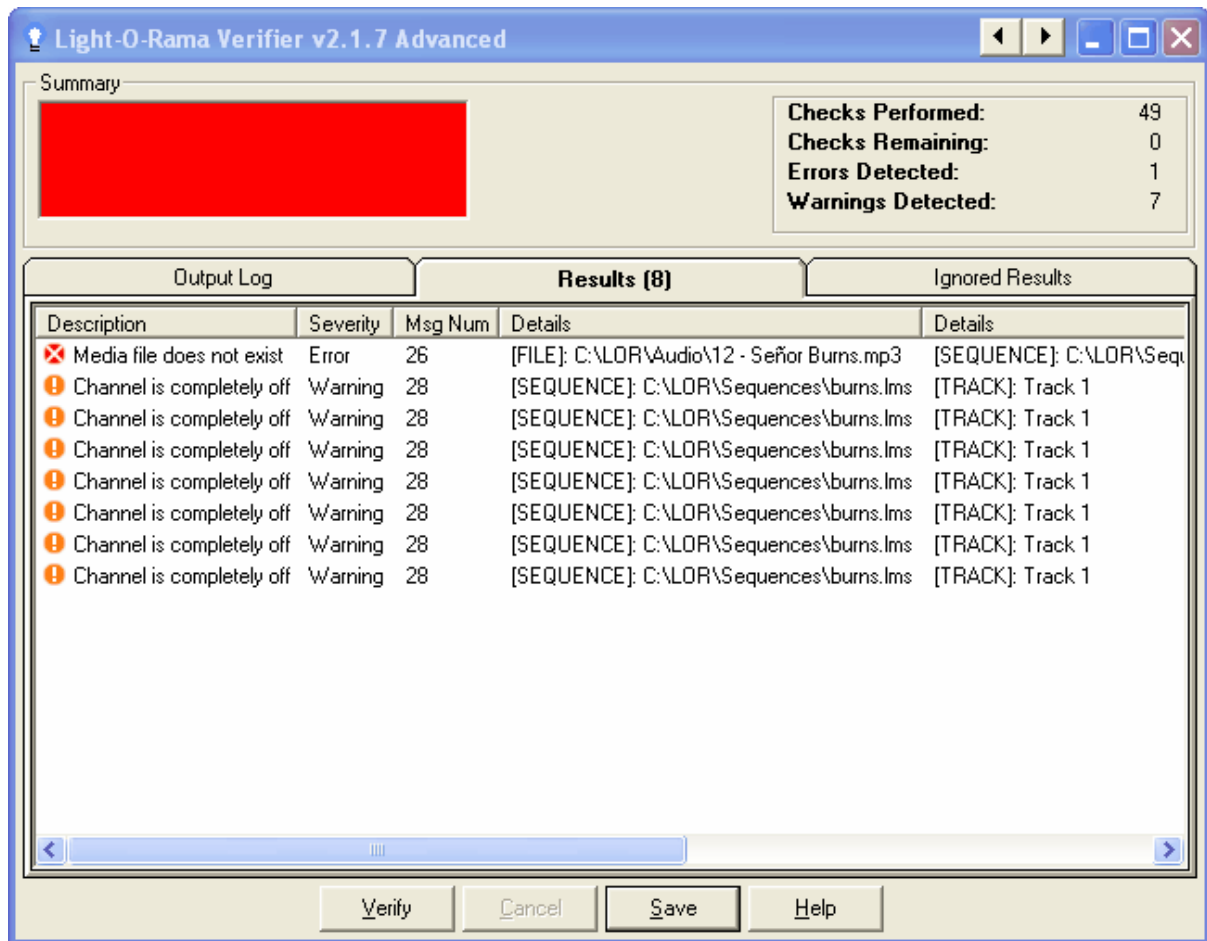

The Verifier has found one error and seven warnings

Each result has a description, severity, and message number, and may have additional details. There are several "Details" columns, each of which may contain a piece of information specific to the detected problem. For example, in the above screenshot, several warning messages appear, all with message number 28, meaning "Channel is completely off". This message number's first "Details" column shows the name of the sequence in which the problem was found and its second "Details" column shows the [track](#) containing the [channel](#) which is completely off. Its third "Details" column (which cannot be seen in the screenshot above, but which could be seen by scrolling to the right) displays the name of the channel.

If you right-click on a particular result, a popup menu will appear:

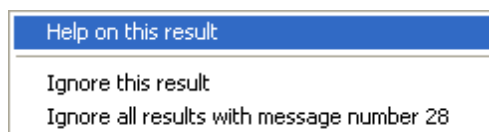

The right-click popup menu for a result

Clicking "Help on this result" simply opens the help file to the page for the result number in question.

The two "ignore" options let you tell the Verifier that you are not interested in seeing this result in the future - either it specifically ("Ignore this result") or all results with the same message number ("Ignore all results with message number 28").

If you ignore a result (or all results with a certain message number), then whenever such results are detected in the future, they will not count towards the number of errors or warnings which the Verifier says it detected, and they will be displayed on the Verifier's "Ignored Results" tab instead of the "Results" tab. You can later decide to stop ignoring such results by going to that tab, right-clicking on a result, and unchecking the ignore option that you had previously selected.

You can also save the list of results to a text file, by clicking the Verifier's "Save" button. Only results on the "Results" tab will be saved to the file; those on the "Ignored Results" will not be.

Please see the [list of Verifier](#) messages for details on the types of problems that the Verifier checks for.

5.13.1 List of Verifier Messages

The following messages can be generated by the [Light-O-Rama Verifier](#). For details on any given one, please refer to its individual help page.

- [Message 1](#) (Info): **No errors or warnings found**
- [Message 2](#) (Warning): **Verification cancelled**
- [Message 3](#) (Error): **Light-O-Rama is not fully installed**
- [Message 4](#) (Error): **No registry entry for application path**
- [Message 5](#) (Error): **Application directory does not exist**
- [Message 6](#) (Warning): **Verifier not running from LOR application path**
- [Message 7](#) (Error): **Application file does not exist**
- [Message 8](#) (Error): **Unlicensed LOR demo version used**
- [Message 9](#) (Warning): **Unsupported version of Windows Media Player**
- [Message 10](#) (Error): **No registry entry for user data path**
- [Message 11](#) (Error): **User data directory does not exist**
- [Message 12](#) (Warning): **No registry entry for non-media data path**
- [Message 13](#) (Warning): **Non-media data directory does not exist**
- [Message 14](#) (Warning): **No registry entry for media data path**
- [Message 15](#) (Warning): **Media data directory does not exist**
- [Message 16](#) (Error): **Application file has unexpected version number**
- [Message 17](#) (Warning): **Weekly schedule file does not exist**
- [Message 18](#) (Warning): **Yearly schedule file does not exist**
- [Message 19](#) (Warning): **Calendar scheduling not supported**
- [Message 20](#) (Warning): **No shows are scheduled**
- [Message 21](#) (Error): **Show file does not exist**
- [Message 22](#) (Error): **Error reading show file**
- [Message 23](#) (Error): **Sequence file does not exist**
- [Message 24](#) (Error): **Sequence file cannot be loaded**
- [Message 25](#) (Warning): **Show has no sequences**
- [Message 26](#) (Error): **Media file does not exist**
- [Message 27](#) (Warning): **Conflicting channel settings in sequence**
- [Message 28](#) (Warning): **Channel is completely off**
- [Message 29](#) (Warning): **Sequence is completely off**
- [Message 30](#) (Warning): **Channel is missing settings**
- [Message 31](#) (Warning): **Channel uses undefined comm network**
- [Message 32](#) (Warning): **Channel in tracks of conflicting length**
- [Message 33](#) (Warning): **Musical file used in non-audio section of show**
- [Message 34](#) (Warning): **Subsequences not supported**
- [Message 35](#) (Warning): **Background sequences unsupported**
- [Message 36](#) (Warning): **Startup sequences unsupported**

- [Message 37](#) (Warning): **Shutdown sequences unsupported**
- [Message 38](#) (Warning): **Interactive triggers unsupported**
- [Message 39](#) (Warning): **Unsupported number of tracks**
- [Message 40](#) (Warning): **Shell commands unsupported**
- [Message 41](#) (Warning): **Shell command map file does not exist**
- [Message 42](#) (Warning): **Shell command not set**
- [Message 43](#) (Warning): **Channel conflict**

5.13.1.1 Verifier Messages 1-10

The following are some messages can be generated by the [Light-O-Rama Verifier](#). For details on any given one, please refer to its individual help page. To see all possible messages, please refer to the [List of Verifier Messages](#).

- [Message 1](#) (Info): **No errors or warnings found**
- [Message 2](#) (Warning): **Verification cancelled**
- [Message 3](#) (Error): **Light-O-Rama is not fully installed**
- [Message 4](#) (Error): **No registry entry for application path**
- [Message 5](#) (Error): **Application directory does not exist**
- [Message 6](#) (Warning): **Verifier not running from LOR application path**
- [Message 7](#) (Error): **Application file does not exist**
- [Message 8](#) (Error): **Unlicensed LOR demo version used**
- [Message 9](#) (Warning): **Unsupported version of Windows Media Player**
- [Message 10](#) (Error): **No registry entry for user data path**

5.13.1.1.1 1: No errors or warnings found

Message Number: 1

Severity: Info

Summary: No errors or warnings found

If the [LOR Verifier](#) does not find any errors or warnings (other than those you have told it to ignore), it will output this message.

[The LOR Verifier](#)

[List of Verifier Messages](#)

5.13.1.1.2 2: Verification cancelled

Message Number: 2

Severity: Warning

Summary: Verification cancelled

If you hit the cancel button while the [LOR Verifier](#) is checking for problems, it will stop checking, display any issues that it has found to that point, and additionally display this message to warn you that there may be other issues that it would have found had it not been cancelled.

Note that it may not stop immediately when you hit the cancel button; it may finish its current check first.

[The LOR Verifier](#)

[List of Verifier Messages](#)

5.13.1.1.3 3: Light-O-Rama is not installed

Message Number: 3**Severity:** Error**Summary:** Light-O-Rama is not fully installed

The installation of Light-O-Rama is not complete. This could occur, for example, if the installation was interrupted, or if a registry cleanup utility deleted certain Light-O-Rama entries from your computer's Windows registry.

If the problem is that the registry entries have been deleted, you can solve it by running the LORPost utility, which is typically automatically run after installation. This utility can be found in the directory where you installed your Light-O-Rama program files, which is typically (but not always) C:\Program Files\Light-O-Rama.

Note that the LORPost utility will ask where your Light-O-Rama data files should be stored. If you already have a "Sequences" directory, and would like to keep your sequences there by default, tell it the directory one level *above* that directory. For example, if your sequences are stored in C:\LOR\Sequences, tell the LORPost utility to store your Light-O-Rama data files in C:\LOR.

Otherwise, try reinstalling Light-O-Rama, or uninstalling and then reinstalling.

[The LOR Verifier](#)[List of Verifier Messages](#)

5.13.1.1.4 4: No registry entry for application path

Message Number: 4**Severity:** Error**Summary:** No registry entry for application path

A required Light-O-Rama entry in the Windows registry cannot be found. This could occur, for example, if the installation was interrupted, or if a registry cleanup utility deleted certain Light-O-Rama entries from your computer's Windows registry. You will not be able to use Light-O-Rama until this problem is resolved.

If the problem is that the registry entries have been deleted, you can solve it by running the LORPost utility, which is typically automatically run after installation. This utility can be found in the directory where you installed your Light-O-Rama program files, which is typically (but not always) C:\Program Files\Light-O-Rama.

Note that the LORPost utility will ask where your Light-O-Rama data files should be stored. If you already have a "Sequences" directory, and would like to keep your sequences there by default, tell it the directory one level *above* that directory. For example, if your sequences are stored in C:\LOR\Sequences, tell the LORPost utility to store your Light-O-Rama data files in C:\LOR.

Otherwise, try reinstalling Light-O-Rama, or uninstalling and then reinstalling.

[The LOR Verifier](#)[List of Verifier Messages](#)

5.13.1.1.5 5: Application directory does not exist

Message Number: 5**Severity:** Error**Summary:** Application directory does not exist**Details:** The name of the directory that is missing

The Windows registry says that the Light-O-Rama program files, such as the [Sequence Editor](#) and the [Hardware Utility](#), can be found in a certain directory, but that directory does not actually exist. You will not be able to use Light-O-Rama until this problem is resolved.

It is suggested to uninstall and reinstall Light-O-Rama.

[The LOR Verifier](#)

[List of Verifier Messages](#)

5.13.1.1.6 6: Verifier not running from LOR application path

Message Number: 6**Severity:** Warning**Summary:** Verifier not running from LOR application path**Details #1:** The name of the directory that LOR program files should be contained in**Details #2:** The name of the directory that the Verifier is running from

The various Light-O-Rama program files, such as the [Sequence Editor](#) and the [Hardware Utility](#), are expected to be found in a certain Windows directory. The [Verifier](#) itself is one such program. However, the copy of the Verifier that you are running is actually contained in a different directory.

This may not be a problem, for example if you intentionally copied the Verifier to a different directory and ran it from there.

However, it might indicate that you are using an old version of the Verifier from a previous installation, and that old Verifier may not be completely compatible with the current installation. Or, it might be indicative of a deeper problem with the installation of Light-O-Rama.

It is suggested that you run the Verifier from the same directory where the Light-O-Rama program files are installed. If you are doing so, and still get this error, consider uninstalling and reinstalling Light-O-Rama.

[The LOR Verifier](#)

[List of Verifier Messages](#)

5.13.1.1.7 7: Application file does not exist

Message Number: 7**Severity:** Error**Summary:** Application file does not exist**Details:** The expected directory and filename of the missing application file

One of the Light-O-Rama program files, such as the [Sequence Editor](#) or the [Hardware Utility](#), cannot be found.

Depending upon exactly what is missing, your [shows](#) may still be able to play. However, they may not,

and in any case, something is definitely wrong.

It is suggested that you uninstall and reinstall Light-O-Rama.

[The LOR Verifier](#)

[List of Verifier Messages](#)

5.13.1.1.8 8: Unlicensed LOR demo version used

Message Number: 8

Severity: Error

Summary: Unlicensed LOR demo version used

Your Light-O-Rama software has not been registered. Until you register it, it will not actually control your lights (and will have [other limitations](#) as well).

This may have occurred for various reasons - for example, it simply may be that you have not yet purchased a Light-O-Rama license. If you do have a license, though, you may not have entered it on this computer, or perhaps you have recently installed a new version of Light-O-Rama (in which case your license may or may not be valid for this new version). Or, perhaps your licensing information has been deleted from the Windows registry, perhaps by a registry cleanup tool.

If you have not yet purchased a license, you can do so from the [Light-O-Rama website](#).

If you have already purchased one, try using it to [register Light-O-Rama](#) on this computer. If this does not work, perhaps you have already installed Light-O-Rama on the maximum number of computers covered by your license, or perhaps your license is for an older version of Light-O-Rama than the one that you are trying to run.

[The LOR Verifier](#)

[List of Verifier Messages](#)

5.13.1.1.9 9: Unsupported version of Windows Media Player

Message Number: 9

Severity: Warning

Summary: Unsupported version of Windows Media Player

The version of Windows Media Player installed on this computer is older than the minimum version required by Light-O-Rama, or, perhaps, Windows Media Player is not correctly installed.

You may still be able to use Light-O-Rama, but it will (at the very least) be severely limited - for example, [musical sequences](#) will not play. It is suggested that you install the latest version of Windows Media Player.

[The LOR Verifier](#)

[List of Verifier Messages](#)

5.13.1.1.10 10: No registry entry for user data path

Message Number: 10

Severity: Error

Summary: No registry entry for user data path

A required Light-O-Rama entry in the Windows registry cannot be found. This could occur, for example, if the installation was interrupted, or if a registry cleanup utility deleted certain Light-O-Rama entries from your computer's Windows registry.

Your [shows](#) will not run successfully until this problem is resolved.

If the problem is that the registry entries have been deleted, you can solve it by running the LORPost utility, which is typically automatically run after installation. This utility can be found in the directory where you installed your Light-O-Rama program files, which is typically (but not always) C:\Program Files\Light-O-Rama.

Note that the LORPost utility will ask where your Light-O-Rama data files should be stored. If you already have a "Sequences" directory, and would like to keep your sequences there by default, tell it the directory one level *above* that directory. For example, if your sequences are stored in C:\LOR\Sequences, tell the LORPost utility to store your Light-O-Rama data files in C:\LOR.

Otherwise, try reinstalling Light-O-Rama, or uninstalling and then reinstalling.

[The LOR Verifier](#)

[List of Verifier Messages](#)

5.13.1.2 Verifier Messages 11-20

The following are some messages can be generated by the [Light-O-Rama Verifier](#). For details on any given one, please refer to its individual help page. To see all possible messages, please refer to the [List of Verifier Messages](#).

- [Message 11](#) (Error): **User data directory does not exist**
- [Message 12](#) (Warning): **No registry entry for non-media data path**
- [Message 13](#) (Warning): **Non-media data directory does not exist**
- [Message 14](#) (Warning): **No registry entry for media data path**
- [Message 15](#) (Warning): **Media data directory does not exist**
- [Message 16](#) (Error): **Application file has unexpected version number**
- [Message 17](#) (Warning): **Weekly schedule file does not exist**
- [Message 18](#) (Warning): **Yearly schedule file does not exist**
- [Message 19](#) (Warning): **Calendar scheduling not supported**
- [Message 20](#) (Warning): **No shows are scheduled**

5.13.1.2.1 11: User data directory does not exist

Message Number: 11

Severity: Error

Summary: User data directory does not exist

Details: The name of the missing directory

The directory that Light-O-Rama expects to find Light-O-Rama data files in does not exist. This could occur, for example, if the installation was interrupted, or if a registry cleanup utility deleted certain Light-O-Rama entries from your computer's Windows registry, or if the directory was deleted or renamed.

Your [shows](#) will not run successfully until this problem is resolved.

You may be able to solve this problem by running the LORPost utility, which is typically automatically run after installation. This utility can be found in the directory where you installed your Light-O-Rama

program files, which is typically (but not always) C:\Program Files\Light-O-Rama.

Note that the LORPost utility will ask where your Light-O-Rama data files should be stored. If you already have a "Sequences" directory, and would like to keep your sequences there by default, tell it the directory one level *above* that directory. For example, if your sequences are stored in C:\LOR\Sequences, tell the LORPost utility to store your Light-O-Rama data files in C:\LOR.

Otherwise, try reinstalling Light-O-Rama, or uninstalling and then reinstalling.

[The LOR Verifier](#)

[List of Verifier Messages](#)

5.13.1.2.2 12: No registry entry for non-media data path

Message Number: 12

Severity: Warning

Summary: No registry entry for non-media data path

A required Light-O-Rama entry in the Windows registry cannot be found. This could occur, for example, if the installation was interrupted, or if a registry cleanup utility deleted certain Light-O-Rama entries from your computer's Windows registry.

Until this problem is resolved, it is possible that your [shows](#) will run successfully, but it is likely that they will not. Even if the shows themselves do run, certain [sequences](#) in them may not.

If the problem is that the registry entries have been deleted, you can solve it by running the LORPost utility, which is typically automatically run after installation. This utility can be found in the directory where you installed your Light-O-Rama program files, which is typically (but not always) C:\Program Files\Light-O-Rama.

Note that the LORPost utility will ask where your Light-O-Rama data files should be stored. If you already have a "Sequences" directory, and would like to keep your sequences there by default, tell it the directory one level *above* that directory. For example, if your sequences are stored in C:\LOR\Sequences, tell the LORPost utility to store your Light-O-Rama data files in C:\LOR.

Otherwise, try reinstalling Light-O-Rama, or uninstalling and then reinstalling.

[The LOR Verifier](#)

[List of Verifier Messages](#)

5.13.1.2.3 13: Non-media data directory does not exist

Message Number: 13

Severity: Warning

Summary: Non-media data directory does not exist

Details: The name of the missing directory

The directory that Light-O-Rama expects to find Light-O-Rama sequence files in does not exist. This could occur, for example, if the installation was interrupted, or if a registry cleanup utility deleted certain Light-O-Rama entries from your computer's Windows registry, or if the directory was deleted or renamed.

Until this problem is resolved, it is possible that your [shows](#) will run successfully, but it is likely that they will not. Even if the shows themselves do run, certain [sequences](#) in them may not.

You may be able to solve this problem by running the LORPost utility, which is typically automatically run after installation. This utility can be found in the directory where you installed your Light-O-Rama program files, which is typically (but not always) C:\Program Files\Light-O-Rama.

Note that the LORPost utility will ask where your Light-O-Rama data files should be stored. If you already have a "Sequences" directory, and would like to keep your sequences there by default, tell it the directory one level *above* that directory. For example, if your sequences are stored in C:\LOR\Sequences, tell the LORPost utility to store your Light-O-Rama data files in C:\LOR.

Otherwise, try reinstalling Light-O-Rama, or uninstalling and then reinstalling.

[The LOR Verifier](#)

[List of Verifier Messages](#)

5.13.1.2.4 14: No registry entry for media data path

Message Number: 14

Severity: Warning

Summary: No registry entry for media data path

A required Light-O-Rama entry in the Windows registry cannot be found. This could occur, for example, if the installation was interrupted, or if a registry cleanup utility deleted certain Light-O-Rama entries from your computer's Windows registry.

Until this problem is resolved, it is possible that your [shows](#) will run successfully, but it is likely that they will not. Even if the shows themselves do run, certain [sequences](#) in them may not.

If the problem is that the registry entries have been deleted, you can solve it by running the LORPost utility, which is typically automatically run after installation. This utility can be found in the directory where you installed your Light-O-Rama program files, which is typically (but not always) C:\Program Files\Light-O-Rama.

Note that the LORPost utility will ask where your Light-O-Rama data files should be stored. If you already have a "Sequences" directory, and would like to keep your sequences there by default, tell it the directory one level *above* that directory. For example, if your sequences are stored in C:\LOR\Sequences, tell the LORPost utility to store your Light-O-Rama data files in C:\LOR.

Otherwise, try reinstalling Light-O-Rama, or uninstalling and then reinstalling.

[The LOR Verifier](#)

[List of Verifier Messages](#)

5.13.1.2.5 15: Media data directory does not exist

Message Number: 15

Severity: Warning

Summary: Media data directory does not exist

Details: The name of the missing directory

The directory that Light-O-Rama expects to find audio and video files in does not exist. This could occur, for example, if the installation was interrupted, or if a registry cleanup utility deleted certain Light-O-Rama entries from your computer's Windows registry, or if the directory was deleted or renamed.

Until this problem is resolved, it is possible that your [shows](#) will run successfully, but it is likely that they will not. Even if the shows themselves do run, certain [sequences](#) in them may not.

You may be able to solve this problem by running the LORPost utility, which is typically automatically run after installation. This utility can be found in the directory where you installed your Light-O-Rama program files, which is typically (but not always) C:\Program Files\Light-O-Rama.

Note that the LORPost utility will ask where your Light-O-Rama data files should be stored. If you already have a "Sequences" directory, and would like to keep your sequences there by default, tell it the directory one level *above* that directory. For example, if your sequences are stored in C:\LOR\Sequences, tell the LORPost utility to store your Light-O-Rama data files in C:\LOR.

Otherwise, try reinstalling Light-O-Rama, or uninstalling and then reinstalling.

[The LOR Verifier](#)
[List of Verifier Messages](#)

5.13.1.2.6 16: Application file has unexpected version number

Message Number: 16

Severity: Error

Summary: Application file has unexpected version number

Details #1: The name of the application file

Details #2: The expected version number of the application file

Details #3: The actual version number of the application file

A certain Light-O-Rama program file, such as the [Sequence Editor](#) or the [Hardware Utility](#), has a version number other than the one that the [Verifier](#) was expecting.

This may be because you are using an old version of the Verifier from a previous installation, and that old Verifier may not be completely compatible with the current installation. Or, it might be indicative of a deeper problem with the installation of Light-O-Rama.

Make sure that you are running the copy of the Verifier that is in the same directory where your current version of Light-O-Rama is installed. If you are doing so, it is suggested that you uninstall and reinstall Light-O-Rama.

[The LOR Verifier](#)
[List of Verifier Messages](#)

5.13.1.2.7 17: Weekly schedule file does not exist

Message Number: 17

Severity: Warning

Summary: Weekly schedule file does not exist

Details: The name of the missing file

The file which is supposed to contain your [weekly schedule](#) does not exist.

If you do not intend to have any [shows scheduled](#) via the weekly schedule, this is not an issue; any shows that you have scheduled via the [calendar schedule](#) should play as scheduled. But if you do intend to have shows scheduled via the weekly schedule, they will not be played until this problem is

resolved.

Perhaps the file was renamed out of the way, in which case you can rename it back to the expected name. Or, perhaps it was deleted; check your computer's Recycle Bin. If neither of these is the problem, then you will have to recreate your weekly schedule via the [Schedule Editor](#) or the [Simple Show Builder](#).

[The LOR Verifier](#)

[List of Verifier Messages](#)

5.13.1.2.8 18: Yearly schedule file does not exist

Message Number: 18

Severity: Warning

Summary: Yearly schedule file does not exist

Details: The name of the missing file

The file which is supposed to contain your [calendar schedule](#) does not exist.

If you do not intend to have any [shows scheduled](#) via the calendar schedule, this is not an issue; any shows that you have scheduled via the [weekly schedule](#) should play as scheduled. But if you do intend to have shows scheduled via the calendar schedule, they will not be played until this problem is resolved.

Perhaps the file was renamed out of the way, in which case you can rename it back to the expected name. Or, perhaps it was deleted; check your computer's Recycle Bin. If neither of these is the problem, then you will have to recreate your weekly schedule via the [Schedule Editor](#) or the [Simple Show Builder](#).

[The LOR Verifier](#)

[List of Verifier Messages](#)

5.13.1.2.9 19: Calendar scheduling not supported

Message Number: 19

Severity: Warning

Summary: Calendar scheduling not supported

Details #1: The date on which a show is scheduled via the calendar

Details #2: The name of the show

A [show](#) is [scheduled](#) via the [calendar schedule](#), but your [license](#) does not support calendar scheduling (or you are using the unlicensed demo version of the software). The show will not play at the scheduled time.

If you already have a license, and have registered Light-O-Rama on this computer, then to get the show to play, you can either upgrade to a higher level license which does support calendar scheduling, or else remove the show from your calendar schedule and schedule it in your [weekly schedule](#) instead.

If you are using the unlicensed demo version, and you have not yet purchased a license, you can do so from the [Light-O-Rama website](#).

If you have already purchased one, try using it to [register Light-O-Rama](#) on this computer. If this does not work, perhaps you have already installed Light-O-Rama on the maximum number of computers

covered by your license, or perhaps your license is for an older version of Light-O-Rama than the one that you are trying to run.

[The LOR Verifier](#)

[List of Verifier Messages](#)

5.13.1.2.10 20: No shows are scheduled

Message Number: 20

Severity: Warning

Summary: No shows are scheduled

You have no [shows scheduled](#). None of your shows will play until you schedule them, via the [Schedule Editor](#) or the [Simple Show Builder](#).

[The LOR Verifier](#)

[List of Verifier Messages](#)

5.13.1.3 Verifier Messages 21-30

The following are some messages can be generated by the [Light-O-Rama Verifier](#). For details on any given one, please refer to its individual help page. To see all possible messages, please refer to the [List of Verifier Messages](#).

- [Message 21](#) (Error): **Show file does not exist**
- [Message 22](#) (Error): **Error reading show file**
- [Message 23](#) (Error): **Sequence file does not exist**
- [Message 24](#) (Error): **Sequence file cannot be loaded**
- [Message 25](#) (Warning): **Show has no sequences**
- [Message 26](#) (Error): **Media file does not exist**
- [Message 27](#) (Warning): **Conflicting channel settings in sequence**
- [Message 28](#) (Warning): **Channel is completely off**
- [Message 29](#) (Warning): **Sequence is completely off**
- [Message 30](#) (Warning): **Channel is missing settings**

5.13.1.3.1 21: Show file does not exist

Message Number: 21

Severity: Error

Summary: Show file does not exist

Details: The name of the missing show file

You have a [show scheduled](#), but the file that is supposed to contain that show does not exist. The show will not play until this problem is resolved.

If you do not want the show to play, this is not a problem, but you may want to remove it from your schedule (using the [Schedule Editor](#)) so that this error message does not appear in the future.

If you do want the show to play, perhaps its file was renamed, or deleted. If it was renamed, either rename it back, or else use the Schedule Editor to point to the new name of the show file instead of the old name. If it was deleted, check your computer's Recycle Bin.

If these suggestions do not resolve the situation, you may have to recreate the show, using the [Show Editor](#).

[The LOR Verifier](#)

[List of Verifier Messages](#)

5.13.1.3.2 22: Error reading show file

Message Number: 22

Severity: Error

Summary: Error reading show file

Details: The name of the show file

You have a [show scheduled](#), but the show cannot be loaded. For example, perhaps the show's file has become corrupted. The show will not play until this problem is resolved.

If you have any backups of the show file, check to see if they work. Otherwise, you may have to recreate the show, using the [Show Editor](#).

[The LOR Verifier](#)

[List of Verifier Messages](#)

5.13.1.3.3 23: Sequence file does not exist

Message Number: 23

Severity: Error

Summary: Sequence file does not exist

Details #1: The name of the missing sequence file

Details #2: The name of the show file that this sequence is referenced in

One of your [scheduled shows](#) refers to a [sequence](#) file that does not exist. The sequence will not play in the show until this problem is resolved.

If you do not want the sequence to play, this is not a problem, but you may want to remove it from the show (using the [Show Editor](#)) so that this message does not appear in the future.

If you do want the sequence to play, perhaps its file was renamed (or placed in a different directory), or deleted.

If it was renamed (or placed in a different directory), you can either rename it back, or else use the Show Editor to point to the new name instead of the old one.

If it was deleted, check your computers Recycle Bin, or any backups that you may have. Note that whenever you change a sequence and save it (using the [Sequence Editor](#)), Light-O-Rama automatically saves a backup copy of the file as it was before your changes, so you may be able to use that backup copy. It will be saved to the same directory as the original, with the file extension ".bak" appended to its name. For example, if your sequence is named "MySequence.las", the automatic backup will be named "MySequence.las.bak".

If none of these suggestions help, you may have to recreate the sequence, using the Sequence Editor.

[The LOR Verifier](#)

[List of Verifier Messages](#)

5.13.1.3.4 24: Sequence file cannot be loaded

Message Number: 24
Severity: Error
Summary: Sequence file cannot be loaded
Details: The name of the file

One of your [scheduled shows](#) refers to a [sequence](#) file that cannot be loaded. For example, perhaps the sequence file has become corrupted. The sequence will not play in the show until this problem is resolved.

If you have any backups of the sequence file, check to see if they work. Note that whenever you change a sequence and save it (using the [Sequence Editor](#)), Light-O-Rama automatically saves a backup copy of the file as it was before your changes, so you may be able to use that backup copy. It will be saved to the same directory as the original, with the file extension ".bak" appended to its name. For example, if your sequence is named "MySequence.las", the automatic backup will be named "MySequence.las.bak".

Otherwise, you may have to recreate the sequence, using the Sequence Editor.

[The LOR Verifier](#)
[List of Verifier Messages](#)

5.13.1.3.5 25: Show has no sequences

Message Number: 25
Severity: Warning
Summary: Show has no sequences
Details: The name of the show file

One of your [scheduled shows](#) has no [sequences](#) in it. This will not cause any problems - your other scheduled shows should play fine - but there isn't much point to scheduling a show without sequences, so this probably indicates a mistake.

If you want sequences to play in the scheduled show, use the [Show Editor](#) to add the sequences to the show.

If you do not want any sequences to play in the scheduled show, consider removing the show from your schedule, using the [Schedule Editor](#), so that this message does not appear in the future.

[The LOR Verifier](#)
[List of Verifier Messages](#)

5.13.1.3.6 26: Media file does not exist

Message Number: 26
Severity: Error
Summary: Media file does not exist
Details #1: The name of the missing media file
Details #2: The name of the sequence file that refers to the missing media file

One of your [scheduled musical sequences](#) refers to an audio file or video file that does not exist. The [sequence](#) will not play until this problem is resolved.

It is possible that the file has been renamed, placed in a different directory, or deleted.

If it has been renamed or placed in a different directory, you can either move it back to its original location, or else use the [Sequence Editor](#) to modify the sequence so that it points to its new location.

If it has been deleted, check your computer's Recycle Bin, or for any backups that you may have of the file.

[The LOR Verifier](#)

[List of Verifier Messages](#)

5.13.1.3.7 27: Conflicting channel settings in sequence

Message Number: 27

Severity: Warning

Summary: Conflicting channel settings in sequence

Details #1: The name of the sequence having the conflict

Details #2: The track containing the first conflicting channel

Details #3: The name of the first conflicting channel

Details #4: The track containing the second conflicting channel

Details #5: The name of the second conflicting channel

One of your [scheduled sequences](#) contains two different [channels](#) that both are set up to control the same physical string of lights - for example, they are both set up to control [circuit](#) 3 of [Light-O-Rama unit](#) 7 on the regular Light-O-Rama [network](#).

Your sequence will play, but these two channels will fight for control over the lights hooked up to the circuit, which may have make the lights behave in ways that you weren't expecting.

The cause of this may simply be that one of the two channels is set up with the wrong unit ID, circuit number, network, or device type. In this case, use the [Sequence Editor](#) to change the channel's settings appropriately.

If you do intend both channels to control the same string of lights, the lights may or may not behave as you expect. The suggested way to do what you probably want is not to have two different channels with the same settings, but to have a single channel that is contained in two different [tracks](#):

Let's say that you have "Channel A" in the first track, and "Channel B" in the second track. These channels have the same physical settings as each other, but different [effect events](#). Then to change this situation to the suggested way, use the Sequence Editor as follows:

First, copy Channel A from the first track to the second track.

Next, merge the effect events from Channel B into Channel A, so that Channel A contains the effect events from both channels.

Finally, delete Channel B.

This will leave you with a single channel - Channel A - which is contained in both tracks, and which contains all of the effect events that you wanted for its string of lights. Having this single channel in two tracks, instead of two different channels in the two tracks, will make the lights behave as you probably expect.

[The LOR Verifier](#)

[List of Verifier Messages](#)

5.13.1.3.8 28: Channel is completely off

Message Number: 28

Severity: Warning

Summary: Channel is completely off

Details #1: The sequence containing the channel

Details #2: The track containing the channel

Details #3: The name of the channel

One of your [scheduled sequences](#) contains a [channel](#) which is completely off for its entire duration.

Consider removing the channel from the sequence, using the [Sequence Editor](#).

[The LOR Verifier](#)

[List of Verifier Messages](#)

5.13.1.3.9 29: Sequence is completely off

Message Number: 29

Severity: Warning

Summary: Sequence is completely off

Details: The name of the sequence file

One of your [scheduled sequences](#) has no [lighting effects](#) for any of its [channels](#), except for having each of them off for the sequence's entire duration.

This may be intentional - for example, you may have scheduled a [musical sequence](#) so that a song plays while your lights are off. Otherwise, consider adding effects to the sequence, or removing the sequence from the [show](#).

[The LOR Verifier](#)

[List of Verifier Messages](#)

5.13.1.3.10 30: Channel is missing settings

Message Number: 30

Severity: Warning

Summary: Channel is missing settings

Details #1: The name of the sequence file containing the channel

Details #2: The track containing the channel

Details #3: The name of the channel

One of your [scheduled sequences](#) has a [channel](#) which is missing a required part of its physical settings - for example, perhaps it does not have a [unit ID](#) set.

This may be intentional - for example, perhaps you have a channel that shows the beat of a song, which you intend to use to help build other channels rather than to actually control lights when your [show](#) plays. If not, though, use the Sequence Editor to set the channel's settings appropriately.

[The LOR Verifier](#)

[List of Verifier Messages](#)

5.13.1.4 Verifier Messages 31-40

The following are some messages can be generated by the [Light-O-Rama Verifier](#). For details on any given one, please refer to its individual help page. To see all possible messages, please refer to the [List of Verifier Messages](#).

- [Message 31](#) (Warning): **Channel uses undefined comm network**
- [Message 32](#) (Warning): **Channel in tracks of conflicting length**
- [Message 33](#) (Warning): **Musical file used in non-audio section of show**
- [Message 34](#) (Warning): **Subsequences not supported**
- [Message 35](#) (Warning): **Background sequences unsupported**
- [Message 36](#) (Warning): **Startup sequences unsupported**
- [Message 37](#) (Warning): **Shutdown sequences unsupported**
- [Message 38](#) (Warning): **Interactive triggers unsupported**
- [Message 39](#) (Warning): **Unsupported number of tracks**
- [Message 40](#) (Warning): **Shell commands unsupported**

5.13.1.4.1 31: Channel uses undefined comm network

Message Number: 31

Severity: Warning

Summary: Channel uses undefined comm network

Details #1: The sequence that the channel is in

Details #2: The track that that the channel is in

Details #3: The name of the channel

One of your [scheduled sequences](#) contains a [channel](#) which is set up to use a network which does not have a comm port defined for it. The channel will not control lights until this issue is resolved.

The channel could be for a [Light-O-Rama controller](#), which can be set up to use one of four different [networks](#), or a [Dasher](#) or [X10 controller](#), each of which can only have one network defined for all controllers of their type.

It is possible that the channel's network (or device type) is simply set incorrectly. For example, perhaps a channel for a Light-O-Rama controller was accidentally set to use the Aux A network, whereas you only have a comm port assigned to the Regular network. Or perhaps a channel was accidentally set to control a Dasher controller, whereas it was intended to control a Light-O-Rama controller. In cases like these, use the [Sequence Editor](#) to change the channel's settings, via the channel's [Channel Settings dialog](#), or via the [Channel Configuration screen](#).

Another possibility is that you do intend to use the network that the channel has assigned to it, but that network is not set up to use any comm port on your computer. In this case, use the Sequence Editor's [Network Preferences dialog](#) to specify a comm port for the network to use.

[The LOR Verifier](#)

[List of Verifier Messages](#)

5.13.1.4.2 32: Channel in tracks of conflicting length

Message Number: 32

Severity: Warning

Summary: Channel in tracks of conflicting length

Details #1: The sequence that the channel is in

Details #2: The name of the channel

Details #3: A track that the channel is in

Details #4: Another track that the channel is in

One of your [scheduled sequences](#) contains a [channel](#) which is in two different [tracks](#), but those tracks are of different lengths. For example, one track is a minute long, while the other is two minutes long.

This will likely cause the lights hooked up to that channel to behave in a way that you don't expect, as different [lighting effects](#) from different parts of the same channel could be sent to the lights in an order that you were not expecting.

Unless you have done this intentionally, and understand the way that your lights will behave because of this, consider using the [Sequence Editor](#) to either remove the channel from one of the tracks or to change the tracks to be of the same length.

[The LOR Verifier](#)

[List of Verifier Messages](#)

5.13.1.4.3 33: Musical file used in non-audio section of show

Message Number: 33

Severity: Warning

Summary: Musical file used in non-audio section of show

Details #1: The sequence file

Details #2: The show file that refers to the sequence

Details #3: The section of the show that refers to the sequence

One of your [musical sequences](#) is [scheduled](#) in a section of a [show](#) that does not support audio or video. For example, perhaps a musical sequence is contained in the [Background section](#) of the show. The sequence will play at its scheduled time, but will only control lights; it will not play audio or display video.

Make sure that the sequence is in the section of the show that you intend it to be in. If it is not, use the [Show Editor](#) to move it to the appropriate section.

If it is in the section that you intended, consider using an animation sequence instead, to avoid possible confusion in the future.

[The LOR Verifier](#)

[List of Verifier Messages](#)

5.13.1.4.4 34: Subsequences not supported

Message Number: 34

Severity: Warning

Summary: Subsequences not supported

Details #1: The name of the subsequence

Details #2: The name of the parent sequence containing the subsequence

Details #3: The name of the channel in the parent sequence referencing the subsequence

One of your [scheduled sequences](#) contains a [channel](#) set up to be a [subsequence](#), but your [license](#)

does not support subsequences (or you are using the unlicensed demo version of the software). The parent sequence will play at its scheduled time, but the subsequence will not.

If you already have a license, and have registered Light-O-Rama on this computer, then to get the subsequence to play, you would have to upgrade to a higher license level which supports subsequences.

If you are using the unlicensed demo version, and you have not yet purchased a license, you can do so from the [Light-O-Rama website](#).

If you have already purchased one, try using it to [register Light-O-Rama](#) on this computer. If this does not work, perhaps you have already installed Light-O-Rama on the maximum number of computers covered by your license, or perhaps your license is for an older version of Light-O-Rama than the one that you are trying to run.

[The LOR Verifier](#)

[List of Verifier Messages](#)

5.13.1.4.5 35: Background sequences unsupported

Message Number: 35

Severity: Warning

Summary: Background sequences unsupported

Details: The name of the show file containing sequences in its Background section

One of your [scheduled shows](#) contains [sequences](#) in its [Background section](#), but your [license](#) does not support sequences in this section. The show will play at its scheduled time, but sequences in this section will not.

If you already have a license, and have registered Light-O-Rama on this computer, then to get these sequences to play, you would have to either move them to a different section of the show, or else upgrade to a higher license level which supports this feature.

If you are using the unlicensed demo version, and you have not yet purchased a license, you can do so from the [Light-O-Rama website](#).

If you have already purchased one, try using it to [register Light-O-Rama](#) on this computer. If this does not work, perhaps you have already installed Light-O-Rama on the maximum number of computers covered by your license, or perhaps your license is for an older version of Light-O-Rama than the one that you are trying to run.

[The LOR Verifier](#)

[List of Verifier Messages](#)

5.13.1.4.6 36: Startup sequences unsupported

Message Number: 36

Severity: Warning

Summary: Startup sequences unsupported

Details: The name of the show file containing sequences in its Startup section

One of your [scheduled shows](#) contains [sequences](#) in its [Startup section](#), but your [license](#) does not support sequences in this section. The show will play at its scheduled time, but sequences in this section will not.

If you already have a license, and have registered Light-O-Rama on this computer, then to get these sequences to play, you would have to either move them to a different section of the show, or else upgrade to a higher license level which supports this feature.

If you are using the unlicensed demo version, and you have not yet purchased a license, you can do so from the [Light-O-Rama website](#).

If you have already purchased one, try using it to [register Light-O-Rama](#) on this computer. If this does not work, perhaps you have already installed Light-O-Rama on the maximum number of computers covered by your license, or perhaps your license is for an older version of Light-O-Rama than the one that you are trying to run.

[The LOR Verifier](#)

[List of Verifier Messages](#)

5.13.1.4.7 37: Shutdown sequences unsupported

Message Number: 37

Severity: Warning

Summary: Shutdown sequences unsupported

Details: The name of the show file containing sequences in its Shutdown section

One of your [scheduled shows](#) contains [sequences](#) in its [Shutdown section](#), but your [license](#) does not support sequences in this section. The show will play at its scheduled time, but sequences in this section will not.

If you already have a license, and have registered Light-O-Rama on this computer, then to get these sequences to play, you would have to either move them to a different section of the show, or else upgrade to a higher license level which supports this feature.

If you are using the unlicensed demo version, and you have not yet purchased a license, you can do so from the [Light-O-Rama website](#).

If you have already purchased one, try using it to [register Light-O-Rama](#) on this computer. If this does not work, perhaps you have already installed Light-O-Rama on the maximum number of computers covered by your license, or perhaps your license is for an older version of Light-O-Rama than the one that you are trying to run.

[The LOR Verifier](#)

[List of Verifier Messages](#)

5.13.1.4.8 38: Interactive triggers unsupported

Message Number: 38

Severity: Warning

Summary: Interactive triggers unsupported

Details: The name of the show file using interactive triggers

One of your [scheduled shows](#) uses interactive triggers, either in an [interactive group](#) or as part of its [startup options](#), but your [license](#) does not support interactive triggers. The show will play at its scheduled time, but its interactive triggers will not.

If you already have a license, and have registered Light-O-Rama on this computer, then to get these triggers to work, you would have to upgrade to a higher license level which supports subsequences. If your triggers are used for interactive groups, you could also move the sequences in them to a different section of the show (but if so, they will play immediately, not upon being triggered).

If you are using the unlicensed demo version, and you have not yet purchased a license, you can do so from the [Light-O-Rama website](#).

If you have already purchased one, try using it to [register Light-O-Rama](#) on this computer. If this does not work, perhaps you have already installed Light-O-Rama on the maximum number of computers covered by your license, or perhaps your license is for an older version of Light-O-Rama than the one that you are trying to run.

[The LOR Verifier](#)

[List of Verifier Messages](#)

5.13.1.4.9 39: Unsupported number of tracks

Message Number: 39

Severity: Warning

Summary: Unsupported number of tracks

Details #1: The name of the sequence using too many tracks

Details #2: The number of tracks the sequence uses

Details #3: The allowed number of tracks

One of your [scheduled sequences](#) uses more [tracks](#) than your [license](#) supports. The sequence will play at its scheduled time, but its excess tracks will not.

If you already have a license, and have registered Light-O-Rama on this computer, then to get these tracks to play, you would have to upgrade to a higher license level which supports more tracks.

If you are using the unlicensed demo version, and you have not yet purchased a license, you can do so from the [Light-O-Rama website](#).

If you have already purchased one, try using it to [register Light-O-Rama](#) on this computer. If this does not work, perhaps you have already installed Light-O-Rama on the maximum number of computers covered by your license, or perhaps your license is for an older version of Light-O-Rama than the one that you are trying to run.

[The LOR Verifier](#)

[List of Verifier Messages](#)

5.13.1.4.10 40: Shell commands unsupported

Message Number: 40

Severity: Warning

Summary: Shell commands unsupported

Details: The name of the sequence using a shell command

One of your [scheduled sequences](#) is set up to use a [Windows shell command](#), but your [license](#) does not support such commands. The sequence will play at its scheduled time, but the command will not be executed.

If you already have a license, and have registered Light-O-Rama on this computer, then to get the command to execute, you would have to upgrade to a higher license level which supports this feature.

If you are using the unlicensed demo version, and you have not yet purchased a license, you can do so from the [Light-O-Rama website](#).

If you have already purchased one, try using it to [register Light-O-Rama](#) on this computer. If this does not work, perhaps you have already installed Light-O-Rama on the maximum number of computers covered by your license, or perhaps your license is for an older version of Light-O-Rama than the one that you are trying to run.

[The LOR Verifier](#)

[List of Verifier Messages](#)

5.13.1.5 Verifier Messages 41-50

The following are some messages can be generated by the [Light-O-Rama Verifier](#). For details on any given one, please refer to its individual help page. To see all possible messages, please refer to the [List of Verifier Messages](#).

- [Message 41](#) (Warning): **Shell command map file does not exist**
- [Message 42](#) (Warning): **Shell command not set**
- [Message 43](#) (Warning): **Channel conflict**

5.13.1.5.1 41: Shell command map file does not exist

Message Number: 41

Severity: Warning

Summary: Shell command map file does not exist

Details: The expected name of the shell command map file

One of your [scheduled sequences](#) is set up to use a [Windows shell command](#), but the command map file that defines the commands to execute does not exist. The sequence will play at its scheduled time, but the command will not be executed.

This could be because you created the sequence on one computer, and moved it to another computer to play in your show, but did not move the command map file. Light-O-Rama keeps these commands in the command map file, rather than in the sequences themselves, due to security concerns. Please see [Sharing Sequences between Computers, and Security](#) for details.

[The LOR Verifier](#)

[List of Verifier Messages](#)

5.13.1.5.2 42: Shell command not set

Message Number: 42

Severity: Warning

Summary: Shell command not set

Details: The name of the sequence file with the missing shell command

One of your [scheduled sequences](#) is set up to use a [Windows shell command](#), but the command map file does not list a command to be executed by that sequence. The sequence will play at its scheduled time, but no command will be executed.

This could be because you created the sequence on one computer, and moved it to another computer to play in your show, but did not move the command map file. Light-O-Rama keeps these commands in the command map file, rather than in the sequences themselves, due to security concerns. Please see [Sharing Sequences between Computers, and Security](#) for details.

[The LOR Verifier](#)
[List of Verifier Messages](#)

5.13.1.5.3 43: Channel conflict

Message Number: 43

Severity: Warning

Summary: Channel conflict

Details #1: The name of the show containing the channel conflict

Details #2: One of the sections of the show containing a sequence with the conflicting channel

Details #3: The sequence file in that section containing the conflicting channel

Details #4: The track in that sequence containing the conflicting channel

Details #5: The name of the conflicting channel in that track

Details #6: Another section of the show containing a sequence with the conflicting channel

Details #7: The sequence file in that section containing the conflicting channel

Details #8: The track in that sequence containing the conflicting channel

Details #9: The name of the conflicting channel in that track

One of your [scheduled shows](#) contains [sequences](#) which could possibly play at the same time, but which each contain a [channel](#) representing the same physical string of lights. For example, perhaps the show contains one sequence in its [Background section](#), and another in its [Musical section](#), which each contain a channel for Light-O-Rama [unit 3 circuit 7](#) on the regular [network](#). Since sequences in the Background section can play at the same time as those in the Musical section, this is a conflict.

The show, and its sequences, will play at the appropriate times, but the two channels may fight for control over the single string of lights that they are set up to use. This may lead to those lights behaving in a manner that you are not expecting.

It is suggested that you use the [Sequence Editor](#) to check whether the channels are set up properly - for example, perhaps the unit ID of one of the channels was mistakenly set to an incorrect value. Otherwise, consider removing the conflicting channel from one of the sequences, or moving one of the sequences to a different section of the show, where it could not be played at the same time as the other sequence.

[The LOR Verifier](#)
[List of Verifier Messages](#)

5.14 Diagnostic

The Light-O-Rama Diagnostic tool can be used in troubleshooting. It shows a snapshot of your Light-O-Rama configuration, such as registry settings and the version numbers of the various Light-O-Rama programs.

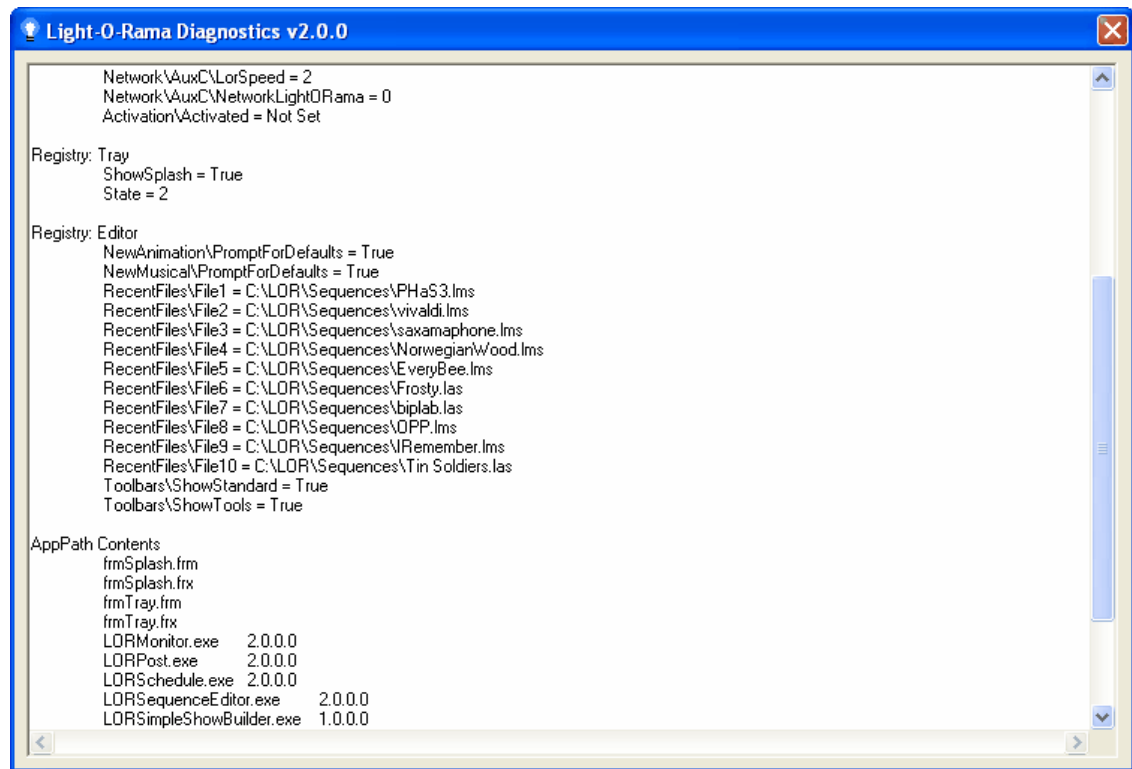

The Light-O-Rama Diagnostic tool

5.15 Offline Registration Utility

The Offline Registration Utility is a program that you can use to help register the [Light-O-Rama Software Package](#) on a computer which is not connected to the internet. It must be run on another computer, which is connected to the internet. If you do not have another computer which is connected to the internet, you can still register an offline computer by calling Light-O-Rama.

Please see the help file page "[Registering Offline](#)" for details.

LOR Offline Registration v2.8.3

Step One
Enter the name that your Light-O-Rama registration is for. Note that you'll have to get upper and lower case exactly the same as they are in your registration information.
Customer Name:

Step Two
Enter your license key. This will be eight groups of five characters, with each character being either a number from 0 through 9 or else a letter from A through F. If any of the eight boxes turns red, that means that the group of five characters in that box is incorrect, so double check what is typed in there.
License Key:

Step Three
Enter the offline registration key from the computer to be registered. This will be similar to the license key - eight groups of five characters, each character being 0 through 9 or A through F, and a box turning red indicating a mistake in that group of characters. If you do not see an offline registration key, make sure that you are using the offline registration form on the computer to be registered, that you have entered your name and license key on that form, and that you have clicked the "Show Offline Registration Key" button.
Registration Key:

Step Four
Click on the register button, and wait for registration. If registration succeeds, Step Five will turn on. Otherwise, an error message will appear.

Step Five
Enter the following authorization key in the offline registration form on the computer to be registered. If you see a box turn red, it indicates a mistake in that box.
Authorization Key:

Error Text

The Offline Registration Utility

5.16 Add-Ons

In addition to the standard programs that come with the [Light-O-Rama software package](#), there are several add-on programs available. These include both official Light-O-Rama products and third-party applications:

- Light-O-Rama Add-Ons

- [The Light-O-Rama Registry Wiper tool](#)
- Third Party Add-Ons
 - [Holiday Lights Designer™](#), by [Holidaysoft®](#)
 - [Universal Library and InstaCal](#)

5.16.1 Registry Wiper

The Light-O-Rama Registry Wiper tool deletes your Light-O-Rama configuration from your computer's registry. This is for use in troubleshooting severe cases.

IMPORTANT: After running the Light-O-Rama Registry Wiper tool, your Light-O-Rama software will not run. You will need to reinstall Light-O-Rama. Also, even after having reinstalled, you will have lost certain preferences settings that you may have previously set.

The Registry Wiper tool is not a standard part of the Light-O-Rama software package. It is available from Light-O-Rama, for troubleshooting severe cases.

The Registry Wiper tool *should not be used* except in extreme situations.

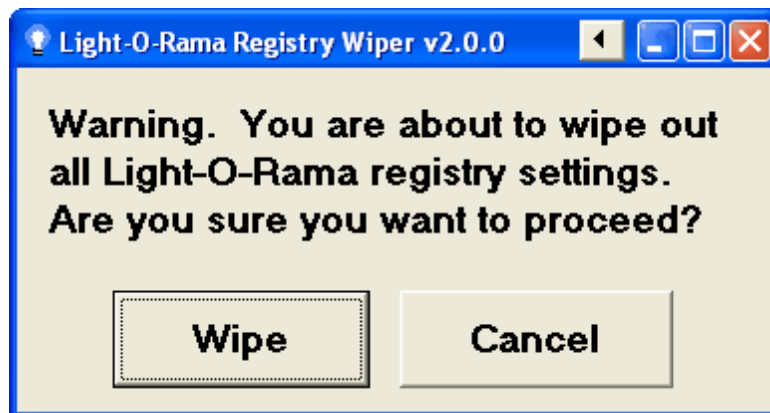

The Light-O-Rama Registry Wiper tool

If you have previously [registered](#) your copy of Light-O-Rama, after selecting "Wipe", you may be presented with a choice of whether to keep your licensing information (such as your license name and license key) in the registry or not. If you choose not to, your copy of Light-O-Rama will run in [Demo mode](#) afterwards, until you re-register. Note, though, that you will still be able to re-register using your exact same licensing information.

5.16.2 Holiday Lights Designer

Holiday Lights Designer™ is a third-party application by Holidaysoft® which can be used to virtually place lights and decorations on images of your home or business. Light-O-Rama can now send Holiday Lights Designer™ commands during play to make those virtual lights behave as your real lights would during a show.

To send commands to Holiday Lights Designer™, first set the [Holiday Lights Designer Preferences](#) in the [Sequence Editor](#) under the [Edit menu](#). After this is done, commands can be sent from the Sequence Editor by turning on "[Control Holiday Lights Designer](#)" in the [Play menu](#), or from the [Show Player](#) by selecting "Holiday Lights Designer On" in the [Light-O-Rama Control Panel](#).

Version 4.0 or above of Holiday Lights Designer™ is required to take advantage of Light-O-Rama

interaction.

For more information about Holiday Lights Designer™, please see the [Holidaysoft website](#).

5.16.3 Universal Library and InstaCal

The Universal Library and InstaCal are software allowing access to [digital IO boards](#) and [BSOFT digital IO boards](#). In order to use these boards with Light-O-Rama, you must have these installed.

The Universal Library and InstaCal are available from [Measurement Computing](#).

Index

- A -

Add-Ons 534
 Holiday Lights Designer 535
 InstaCal 536
 Registry Wipe Utility 535
 Universal Library 536
 Advanced OpenGL Settings (Sequence Editor) 212
 Animation 119
 Animation Redraw Throttling 211
 Animation Section (Show) 128
 Animation Sequence 87
 New Animation Dialog 184
 New Animation Preferences 226
 Animator 322
 Animation Redraw Throttling 211
 Background Images 324
 Drawing 323
 Sizing and Zooming 323
 Audio Visualizations 230

- B -

Background Effects Mode 112
 Background Section (Show) 126
 Beat Wizard 325
 BSOF Digital IO Cards 153
 Circuit IDs 154
 Hardware Utility 437
 InstaCal 536
 Limitations 153
 Requirements 153
 Unit IDs 153
 Universal Library 536

- C -

Cable
 Data 9
 Phone 9
 Calendar Schedule 141
 Channel 89, 295, 310, 328
 Channel Settings 297

Subsequence 120
 Channel and RGB Channel Buttons (Sequence Editor)
 Channel and RGB Channel Buttons (Sequence Editor) 295
 Convert to RGB Channel 310
 Convert to RGB Channel (Sequence Editor) 310
 Insert Device 303
 Popup Menu 298
 Channel Buttons (Sequence Editor)
 Vary Color by Default 228
 View by Default 206
 Channel Configuration Screen 328
 Channel Group 95
 Channel Settings 297
 Circuit IDs
 BSOF Digital IO Cards 154
 Dasher Controllers 149
 Digital IO Cards 152
 Light-O-Rama Controllers 145
 Clipboard Preferences (Sequence Editor) 205
 Clipboards (Sequence Editor) 283
 Comm Listener 410
 Companion Unit 8
 Compressed Sequences 124
 Control Panel 160
 Disable Shows Gracefully 166
 Disable Shows Immediately 166
 Enable Schedule 165
 Hardware Utility Quicklaunch 165
 Holiday Lights Designer 168
 Launch at Startup 167
 Popup Menu 163
 Schedule Editor Quicklaunch 165
 Sequence Editor Quicklaunch 164
 Show Editor Quicklaunch 164
 Show On Demand 166
 Shut Down Show On Demand 167
 Simple Show Builder Quicklaunch 165
 Status Window 160
 Unload Light-O-Rama 168
 Controllers 143
 BSOF Digital IO 153
 Dasher 148
 Digital IO 151
 DMX 148
 Light-O-Rama 144
 X10 154
 Convert to RGB Channel (Sequence Editor) 310

- D -

Daisy Chain 8

Dasher

- Circuit IDs 149
- Controllers 148
- Dasher Port 148
- Importing Dasher Files 150
- Unit IDs 149

Data Cable 9

Diagnostic Utility 532

Digital IO Boards Tab (Hardware Utility) 437

Digital IO Cards 151

- Circuit IDs 152
- Hardware Utility 437
- InstaCal 536
- Limitations 152
- Requirements 152
- Unit IDs 152
- Universal Library 536

Director Unit 9

Disable Shows Gracefully (Control Panel) 166

Disable Shows Immediately (Control Panel) 166

Display Preferences (Sequence Editor) 206

- Animation Redraw Throttling 211
- Channel Buttons 206
- Fades as Ramps 207
- Time Scale 208
- Tooltip Preferences 210
- Wave Form 209

DMX 439

- Comm Listener 410
- Controllers 148

DMX Intensity Effect 110

DMX Preferences (Sequence Editor) 213

- E -

Edit Menu (Sequence Editor) 190

Editing Sequences

- Keyboard 170
- Keyboard Preferences 214
- Mouse 176

Effect 105

- Background Effects Mode 112
- Custom Tool 109

- DMX Intensity 110
- Fade Down 108
- Fade Up 108
- Faded Twinkles and Shimmers 109
- Foreground Effects Mode 112
- Normal Effects Mode 112
- Off 105
- On 105
- Set Intensity 105
- Shimmer 107
- Twinkle 107

Effect Tools (Sequence Editor) 242

- Custom 251
- DMX Intensity 251
- Fade Down 244
- Fade Up 244
- Off 244
- On 243
- Select 243
- Set Intensity 244
- Settings 251
- Shimmer 243
- Toggle 243
- Tools Toolbar 273
- Twinkle 243

Enable Schedule (Control Panel) 165

- F -

Fade Down Effect 108

Fade Up Effect 108

Fades 108

- Faded Twinkles and Shimmers 109
- View Menu 237

File Menu (Sequence Editor) 179

- Close 180
- Close All Files 180
- Close All Files Except This 180
- Exit 181
- Export as Protected 181
- New 179
- Open 180
- Open Recent 180
- Revert to Save 180
- Save 181
- Save As 181

Firmware Updates 429

Fixed Timing Grids 103

Foreground Effects Mode 112
Freeform Play Mode 345
Freeform Timing Grids 103

- G -

Getting Help 8
Getting Started 8

- H -

Hardware 143
Hardware Utility 410
 Configuring Units 415
 Digital IO Boards Tab 437
 Downloading Sequences 425
 Firmware Updates 429
 LOR Control Tab 411
 LOR MP3 Tab 431
 LOR RF Tab 435
 Selecting a Comm Port 412
 Setting Unit IDs 413
 Test Console 439
 Testing Units 421
 X10 CM11A Tab 438
Help 8
Help Menu (Sequence Editor) 267
Highlight Current Event by Default (Sequence Editor)
 229
Highlight Current Time by Default (Sequence Editor)
 229
Holiday Lights Designer 535
 Control Holiday Lights Designer (Sequence Editor)
 264
 Control Panel 168
 Preferences 213
Holiday Lights Designer Preferences (Sequence
Editor) 213

- I -

Insert Device (Sequence Editor) 303
InstaCal 536
Interactive Groups (Show) 134
 Jukebox 136
 Magic Toy 137
 Soundboard 137

Interactive Section (Show) 130

- J -

Jukebox 136

- K -

Keyboard (Sequence Editor) 170
 Keyboard Preferences 214
Keyboard Preferences (Sequence Editor) 214

- L -

Launch at Startup (Control Panel) 167
Lighting Effect 105
Light-O-Rama Controllers 144
 Companion Unit 8
 Configuring Units (Hardware Utility) 415
 Director Unit 9
 Downloading Sequences (Hardware Utility) 425
 Firmware Updates (Hardware Utility) 429
 Hardware Utility 411
 Setting Unit IDs (Hardware Utility) 413
 Testing Units (Hardware Utility) 421
Light-O-Rama Network 145
List of Verifier Messages 511
Loop 114
 Loop Context Menu 316
 Loop Level Buttons 319
 Loop Menus 315
Loop at End by Default (Sequence Editor) 229
Loop Context Menu 316
Loop Level 114
Loop Level Buttons (Sequence Editor) 319
Loop Menus (Sequence Editor) 315
 Loop Context Menu 316
 Loop Level Buttons 319
LOR Control Tab (Hardware Utility) 411
LOR MP3 Tab (Hardware Utility) 431
LOR RF Tab (Hardware Utility) 435

- M -

Magic Toy 137
Menu Bar (Sequence Editor) 178
MIDI Wizard 332

MIDI Wizard 332
 Effects Summary Tab 333
 Individual Notes Tab 337
 Various Effects Tab 334
 Mouse (Sequence Editor) 176
 MP3 Directors
 Hardware Utility 431
 Musical Section (Show) 129
 Musical Sequence 88
 New Musical Sequence Dialog 187
 New Musical Sequence Preferences 226

- N -

Network 145
 Connection Speed 224
 Preferences (Sequence Editor) 222
 Serial Port 223
 Network Preferences (Sequence Editor) 222
 New and Open Dialog 181
 New Animation Dialog 184
 New Animation Preferences (Sequence Editor) 226
 New Musical Sequence Dialog 187
 New Musical Sequence Preferences (Sequence Editor) 226
 New Track Dialog 202
 Normal Effects Mode 112

- O -

Off Effect 105
 On Effect 105

- P -

Phone Cable 9
 Play Menu (Sequence Editor) 260
 Control Holiday Lights Designer 264
 Control Lights 264
 Highlight Current Time 265
 Loop at End 263
 Move Grid with Play 264
 Play Again 262
 Play Range 262
 Speed 265
 Start All Sequences 261
 Start This Sequence 261

Stop 262
 Vary Color of Channel Buttons 264
 Play Preferences (Sequence Editor) 227
 Highlight Current Event 229
 Highlight Current Time 229
 Loop at End 229
 Vary Channel Button Colors 228
 Play Range 262
 Play Speed 265
 Preferences (Sequence Editor) 204
 Advanced OpenGL Settings 212
 Clipboard 205
 Display 206
 DMX 213
 Holiday Lights Designer 213
 Keyboard Preferences 214
 Network 222
 New Animation 226
 New Musical Sequence 226
 Play 227
 Video 230
 Visualizer 221
 Zoom 231
 Protected Sequences 125

- R -

Registry Wipe Utility 535
 RGB Channel 92, 298
 Channel and RGB Channel Buttons (Sequence Editor) 295
 Convert to RGB Channel (Sequence Editor) 310
 RGB Channel Settings
 RGB Channel Settings 298
 Right-Click Context Menu (Sequence Editor) 289
 Background Effects 292
 Copy 293
 Copy Timing 293
 Cut 293
 Delete Selected Timings 294
 Delete Timing at (centisecond) 294
 Fade Down 291
 Fade Up 291
 Foreground Effects 292
 Insert Multiple Timings 294
 Insert Timing at (centisecond) 294
 Insert Timing at ... 294
 Off 292

- Right-Click Context Menu (Sequence Editor) 289
 - On 292
 - Paste 293
 - Paste Multiple 293
 - Paste Timing at (centisecond) 294
 - Paste Timing at ... 293
 - Paste Timing Multiple 294
 - Resize Timings to ... 295
 - Resize Timings to Equal Times 295
 - Set Intensity 292
 - Shimmer 292
 - Toggle 292
 - Twinkle 292

- S -**

- Schedule 139
 - Calendar Schedule 141
 - Schedule Editor 397
 - Weekly Schedule 140
- Schedule Editor 397
- Sequence 84
 - Animation 119
 - Animation Sequence 87
 - Channel 89
 - Channel Group 95
 - Closing Sequences 180
 - Effect 105
 - Loop 114
 - Musical Sequence 88
 - Reverting Changes 180
 - RGB Channel 92
 - Saving Changes 181
 - Sequence Editor 169
 - Sequence Info 238
 - Subsequence 120
 - SuperStar Sequencer 346
 - Timing 102
 - Track 116
- Sequence Editor 169
 - Animator 322
 - Beat Wizard 325
 - Channel and RGB Channel Buttons 295
 - Channel Configuration Screen 328
 - Channel Settings 297
 - Clipboards 283
 - Edit Menu 190
 - File Menu 179
 - Freeform Play Mode 345
 - Help Menu 267
 - Keyboard 170
 - Keyboard Preferences 214
 - Loop Menus 315
 - Menu Bar 178
 - MIDI Wizard 332
 - Mouse 176
 - New and Open Dialog 181
 - New Animation Dialog 184
 - New Musical Sequence Dialog 187
 - New Track Dialog 202
 - Play Menu 260
 - RGB Channel Settings 298
 - Right-Click Context Menu 289
 - Tapper Wizard 339
 - Time Format 178
 - Toolbars 268
 - Tools Menu 240
 - Track Bars 312
 - View Menu 231
 - VU Wizard 342
 - Waveform 319
 - Window Menu 265
- Sequence Info 238
- Sequence-in-Sequence Play 120
- Sequences
 - Compressed Sequences 124
 - Protected Sequences 125
 - Shell Commands 121
 - Windows Shell Commands 121
- ServoDog Utility 441
- Set Intensity Effect 105
- Shell Commands 121
- Shimmer Effect 107
- Show 125
 - Animation Section 128
 - Background Section 126
 - Immediate Background Startup 133
 - Immediate Startup 133
 - Interactive Groups 134
 - Interactive Section 130
 - Jukebox 136
 - Magic Toy 137
 - Musical Section 129
 - Show Editor 395
 - Show On Demand 166
 - Show Player 409

- Show 125
 - Shutdown Section 131
 - Simple Show Builder 403
 - Soundboard 137
 - Startup Options 132, 133
 - Startup Section 127
 - Triggered Startup 133
 - Show Editor 395
 - Show On Demand (Control Panel) 166
 - Show Player 409
 - Shut Down Show On Demand (Control Panel) 167
 - Shutdown Section (Show) 131
 - Simple Show Builder 403
 - Software 156
 - Add-Ons 534
 - Comm Listener 410
 - Control Panel 160
 - Diagnostic Utility 532
 - Hardware Utility 410
 - Holiday Lights Designer 535
 - InstaCal 536
 - Registry Wipe Utility 535
 - Schedule Editor 397
 - Sequence Editor 169
 - ServoDog Utility 441
 - Show Editor 395
 - Show Player 409
 - Simple Show Builder 403
 - SuperStar Sequencer 346
 - Universal Library 536
 - Verifier 509
 - Soundboard 137
 - Standalone Mode 425
 - Standard Toolbar (Sequence Editor) 268
 - Close Sequence 269
 - Copy 270
 - Cut 269
 - New Sequence 269
 - Open Sequence 269
 - Paste 270
 - Play 272
 - Play Again 272
 - Redo 271
 - Save Sequence 269
 - Stop 272
 - Undo 271
 - Vary Channel Button Colors 271
 - View Animation 271
 - View Fades as Ramps 271
 - View Time Scale 271
 - View Waveform 272
 - Zoom Channels In 272
 - Zoom Channels Out 272
 - Zoom Time In 272
 - Zoom Time Out 272
 - Startup Section (Show) 127
 - Status Window (Control Panel) 160
 - Subsequence 120
 - SuperStar Sequencer 346
 - Animation 363
 - Balanced Color Mode 379
 - Channelizer 384
 - Clipboards 374
 - Commands 391
 - Custom Sequences 351
 - Export 355
 - Full Color Mode 379
 - Image Action 361
 - Importing Timing Grid 387
 - Instant Sequences 349
 - Keyboard Accelerators 391
 - Layout Dialog Box 378
 - Morph 357
 - Overview 347
 - Pixels per Ribbon 375
 - Scene 352
 - Select All 387
 - Select All Left 387
 - Select All Right 387
 - Smooth Ramps 380
 - Star Rays 377
 - Text 367
 - Thin Grid 377
 - Transfer Effects 374
 - Unit IDs, Hardware Utility 382
 - Unit IDs, SuperStar Sequencer 382
 - Visualization Sequences 387
 - Welcome 346
 - Wide Grid 377
- T -
- Tapper Wizard 339
 - Time Format 178
 - Timing 102
 - Timing Grids 103

- Timing Grids 103
 - Fixed 103
 - Freeform 103
 - Toolbars (Sequence Editor) 268
 - Standard Toolbar 268
 - Tools Toolbar 273
 - Tracks and Timings Toolbar 277
 - Tools Menu (Sequence Editor) 240
 - Background Effects 252
 - Beat Wizard 256
 - Channel Configuration 255
 - Custom 251
 - Custom Settings 252
 - DMX Intensity 251
 - Effect Tool Settings 251
 - Effect Tools 242
 - Fade Down 244
 - Fade Tool Options 254
 - Fade Tool Settings 253
 - Fade Up 244
 - Foreground Effects 252
 - Intensity Tool Options 253
 - Intensity Tool Settings 252
 - Load Intensities and Fades 255
 - MIDI Wizard 257
 - Off 244
 - On 243
 - Select 243
 - Set Intensity 244
 - Shimmer 243
 - Tapper Wizard 258
 - Toggle 243
 - Twinkle 243
 - VU Wizard 259
 - Tools Toolbar (Sequence Editor) 273
 - Background Effects 276
 - Custom 275
 - Custom Fade Down 276
 - Custom Fade Up 276
 - Custom Set Intensity 276
 - Custom Shimmer 275
 - Custom Twinkle 275
 - DMX Intensity 275
 - Fade Down 274
 - Fade Settings 276
 - Fade Up 274
 - Foreground Effects 276
 - Intensity Settings 276
 - Off 274
 - On 274
 - Select 274
 - Set Intensity 274
 - Shimmer 274
 - Toggle 274
 - Twinkle 274
 - Track 116
 - New Track Dialog 202
 - Track Bars 312
 - Track Info 238
 - Track Bars (Sequence Editor) 312
 - Popup Menus 313
 - Track Info 238
 - Tracks and Timings Toolbar (Sequence Editor) 277
 - Twinkle Effect 107
- U -**
- Unit 10
 - Unit IDs
 - BSOFT Digital IO Cards 153
 - Dasher Controllers 149
 - Digital IO Cards 152
 - Light-O-Rama Controllers 144
 - Setting Unit IDs (Hardware Utility) 413
 - X10 Controllers 156
 - Universal Library 536
 - Unload Light-O-Rama (Control Panel) 168
- V -**
- Vary Channel Button Colors by Default (Sequence Editor) 228
 - Verifier 509
 - List of Verifier Messages 511
 - Video
 - Display Audio Visualizations 230
 - Display Video 230
 - Full Screen Mode 231
 - Monitor 231
 - Preferences 230
 - View Menu (Sequence Editor) 231
 - Animation 236
 - Cell Info 239
 - Channel Buttons 232
 - Fades 237

-
- View Menu (Sequence Editor) 231
 - Refresh 240
 - Sequence Info 238
 - Time Scale 234
 - Toolbars 240
 - Tools Panel 240
 - Track Info 238
 - Video 236
 - Wave Form 234
 - Zoom Columns 240
 - Zoom Rows 239
 - Visualizer 442
 - About 462
 - Actions Toolbar 505
 - Advanced Topics 451
 - Arch/Fan Wizard 453, 462
 - Assign Fixtures from Wizard 464
 - Assign to Fixture 465
 - Bulbs Options 495
 - CCR Matrix Wizard 453, 466
 - CCR Wizard 453
 - Change Size 467
 - Channel Assignment Wizard 454
 - Channel Assignment Wizard: CCR Fixtures 474
 - Channel Assignment Wizard: Non-CCR Fixtures 468
 - Channel Assingment Wizard 468
 - Channel Settings Dialog 476
 - Color Toolbar 506
 - Colors and Background Intensity 458
 - Colors Options 494
 - Com/Ref Options 496
 - Compile Errors 504
 - Concepts and Terminology 444
 - Cosmic Color Devices 458
 - Dialog Windows 461
 - Draw CCR Wizard 477
 - Edit Toolbar 504
 - Firewalls 460
 - Fixture Properties 481
 - Fixtures Options 494
 - General Options 490
 - Importing and Exporting Fixtures and Props 456
 - Insert Symbol Fixture 483
 - Level Visibility and Properties 485
 - Levels 458
 - Limits 443
 - Load LOR Reference File 487
 - Locks 457
 - Main Editing Window 487
 - Main Editor Window 487
 - Menu Items 488
 - Mouse Wheel 509
 - Multi-Color Channels (Strings) 459
 - New Prop 488
 - New Simulation 489
 - Object Selection Area 490
 - Options 490
 - Options: Bulbs 495
 - Options: Colors 494
 - Options: Com/Ref 496
 - Options: Fixtures 494
 - Options: General 490
 - Options: Tooltips 492
 - Preferences 221
 - Prop Properties 497
 - Prop Properties (Channel Wizard) 499
 - Prop Properties (Fixture Properties) 498
 - Prop Properties (General) 497
 - Reference Channels 455
 - Rename Fixture 500
 - Rename Prop 500
 - Reorder Prop 501
 - Select Reference Channel 501
 - Shortcut Keys 509
 - Simulation (Background) Properties 502
 - Simulation and Firewalls 460
 - Status Bar 504
 - Symbols 457
 - System Requirements 443
 - Toolbars 504
 - Tooltips Options 492
 - Tree Wizard 452, 506
 - Tutorial 446
 - Virtual Channels 456
 - Wizards 452
 - Visualizer Preferences (Sequence Editor) 221
 - VU Wizard 342
- W -**
- Waveform 319
 - Weekly Schedule 140
 - What's New 13
-

Window Menu (Sequence Editor) 265
 Arrange Icons 266
 Cascade 266
 Minimize All Windows 266
 Open Sequence List 266
 Tile Horizontally 266
 Tile Vertically 266
Windows Shell Commands 121
Wireless Devices
 Hardware Utility 435

- X -

X10
 Controllers 154
 Hardware Utility 438
 Limitations 155
 Unit IDs 156
 X10 Port 155
X10 CM11A Tab (Hardware Utility) 438

- Z -

Zoom Preferences (Sequence Editor) 231